

**KURZWEIL®**

# CUP | P1 (G1)

## USER'S MANUAL

English Manual

**HDC** YOUNG CHANG



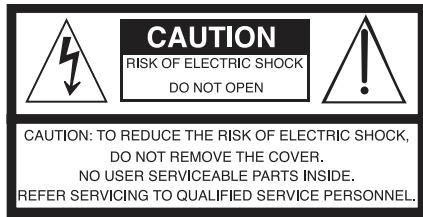

The lightning flash with the arrowhead symbol, within an equilateral triangle is intended to alert the user to the presence of uninsulated "dangerous voltage" within the product's enclosure that may be of sufficient magnitude to constitute a risk of electric shock to persons.



The exclamation point within an equilateral triangle is intended to alert the user to the presence of important operating and maintenance (servicing) instructions in the literature accompanying the product.

## IMPORTANT SAFETY & INSTALLATION INSTRUCTIONS

### INSTRUCTIONS PERTAINING TO THE RISK OF FIRE ELECTRIC SHOCK , OR INJURY TO PERSONS

**WARNING:** When using electric products, basic precautions should always be followed, including the following:

1. Read all the Safety and Installation Instructions and Explanation of Graphic Symbols before using the product.
2. This product must be grounded. If it should malfunction or break down, grounding provides a path of least resistance for electric current to reduce the risk of electric shock. This product is equipped with a power supply cord having an equipment-grounding conductor and a grounding plug. The plug must be plugged into an appropriate outlet which is properly installed and grounded in accordance with all local codes and ordinances.  
**DANGER:** Improper connection of the equipment-grounding conductor can result in a risk of electric shock. Do not modify the plug provided with the product – if it will not fit the outlet, have a proper outlet installed by a qualified electrician. Do not use an adaptor which defeats the function of the equipment-grounding conductor. If you are in doubt as to whether the product is properly grounded, check with a qualified serviceman or electrician.
3. Do not use this product near water for example, near a bathtub, washbowl, kitchen sink, in a wet basement, or near a swimming pool, or the like.
4. This product should only be used with a stand or cart that is recommended by the manufacturer.
5. This product, either alone or in combination with an amplifier and speakers or headphones, may be capable of producing sound levels that could cause permanent hearing loss. Do not operate for a long period of time at a high volume level or a level that is uncomfortable. If you experience any hearing loss or ringing in the ears, you should consult an audiologist.
6. This product should be located so that its location or position does not interfere with its proper ventilation.
7. The product should be located away from heat sources such as radiators, heat registers, or other products that produce heat.
8. The product should be connected to a power supply only of the type described in the operating instructions or as marked on the product.
9. This product may be equipped with a polarized line plug (one blade wider than the other). This is a safety feature. If you are unable to insert the plug into the outlet, contact an electrician to replace your obsolete outlet. Do not defeat the safety purpose of the plug.
10. The power supply cord of the product should be unplugged from the outlet when left unused for a long period of time. When unplugging the power supply cord, do not pull on the cord, but grasp it by the plug.
11. Care should be taken so that objects do not fall and liquids are not spilled into the enclosure through openings.
12. The product should be serviced by qualified service personnel when:
  - A. The power supply cord or the plug has been damaged;
  - B. Objects have fallen, or liquid has been spilled into the product;
  - C. The product has been exposed to rain;
  - D. The product does not appear to be operating normally or exhibits a marked change in performance;
  - E. The product has been dropped, or the enclosure damaged.
13. Do not attempt to service the product beyond that described in the user maintenance instructions. All other servicing should be referred to qualified service personnel.
14. **WARNING:** Do not place objects on the product's power supply cord, or place the product in a position where anyone could trip over, walk on, or roll anything over cords of any type. Do not allow the product to rest on or be installed over cords of any type. Improper installations of this type create the possibility of a fire hazard and/or personal injury.

## RADIO AND TELEVISION INTERFERENCE

**WARNING:** Changes or modifications to the instrument not expressly approved by Young Chang could void your authority to operate the instrument.

**IMPORTANT:** When connecting this product to accessories and/or other equipment use only high quality shielded cables.

**NOTE:** This instrument has been tested and found to comply with the limits for a Class B digital device, pursuant to Part 15 of the FCC Rules. These limits are designed to provide reasonable protection against harmful interference in a residential installation. This instrument generates, uses, and can radiate radio frequency energy and, if not installed and used in accordance with the instructions, may cause harmful interference to radio communications. However, there is no guarantee that interference will not occur in a particular installation. If this instrument does cause harmful interference to radio or television reception, which can be determined by turning the instrument off and on, the user is encouraged to try to correct the interference by one or more of the following measures:

- Reorient or relocate the receiving antenna.
- Increase the separation between the instrument and the receiver.
- Connect the instrument into an outlet on a circuit other than the one to which the receiver is connected.
- If necessary consult your dealer or an experienced radio/television technician for additional suggestions.

The normal function of this product may be disturbed by strong electro magnetic interference. If so, simply reset the product to resume normal operation by following the instruction manual. In case the function could not resume, please use the product in another location.

### NOTICE

This apparatus does not exceed the Class B limits for radio noise emissions from digital apparatus set out in the Radio Interference Regulations of the Canadian Department of Communications.

### AVIS

Le présent appareil numérique n'émet pas de bruits radioélectriques dépassant les limites applicables aux appareils numériques de la class B prescrites dans le Règlement sur le brouillage radioélectrique édicté par le ministère des Communications du Canada.

## SAVE THESE INSTRUCTIONS

## **IMPORTANT SAFETY INSTRUCTIONS**

1. Read these instructions.
2. Keep these instructions.
3. Heed all warnings.
4. Follow all instructions.
5. Do not use this apparatus near water.
6. Clean only with dry cloth.
7. When cleaning the top panel of the product, be sure to clean it with the power turned off as it may cause an error in operation.
8. Do not block any of the ventilation openings. Install in accordance with the manufacturer's instructions.
9. Do not install near any heat sources such as radiators, heat registers, stoves, or other apparatus (including amplifiers) that produce heat.
10. Do not defeat the safety purpose of the polarized or grounding-type plug. A polarized plug has two blades with one wider than the other. A grounding type plug has two blades and a third grounding prong. The wide blade or the third prong are provided for your safety. If the provided plug does not fit into your outlet, consult an electrician for replacement of the obsolete outlet.
11. Protect the power cord from being walked on or pinched, particularly at plugs, convenience receptacles, and the point where they exit from the apparatus.
12. Only use attachments/accessories specified by the manufacturer.
13. Use only with a cart, stand, tripod, bracket, or table specified by the manufacturer, or sold with the apparatus. When a cart is used, use caution when moving the cart/apparatus combination to avoid injury from tip-over.
14. Unplug this apparatus during lightning storms or when unused for long periods of time.
15. Refer all servicing to qualified service personnel. Servicing is required when the apparatus has been damaged in any way, such as power-supply cord or plug is damaged, liquid has been spilled or objects have fallen into the apparatus, the apparatus has been exposed to rain or moisture, does not operate normally, or has been dropped.
16. Allow adequate ventilation for the power adapter. Do not hide it under a carpet or behind a curtain or place it in an enclosed space where heat buildup can occur.



**WARNING:** To reduce the risk of fire or electric shock, do not expose this apparatus to rain or moisture.

Do not expose this equipment to dripping or splashing and ensure that no objects filled with liquids, such as vases, are placed on the equipment.

To completely disconnect this equipment from the AC Mains, disconnect the power supply cord plug from the AC receptacle.

## Kurzweil International Contacts

Contact the appropriate Kurzweil office listed below to locate your local Kurzweil representative.

### US Customers:

Artesia-Pro Inc.  
P.O. Box 2908  
La Mesa, CA 91943

Phone: 619/244-0006  
Email: support@artesia-pro.com

[www.artesia-pro.com](http://www.artesia-pro.com)

### Customers Outside the US:

HDC Young Chang Co., LTD.

South Korea  
Tel: +82 32 570 1000

[www.hdc-youngchang.com](http://www.hdc-youngchang.com)



<http://kurzweil.com>



[www.facebook.com/kurzweilhome/](http://www.facebook.com/kurzweilhome/)



<https://www.instagram.com/kurzweilmusic/>



[www.threads.net/kurzweilmusic](http://www.threads.net/kurzweilmusic)



[www.twitter.com/KurzweilMusic](http://www.twitter.com/KurzweilMusic)



[www.youtube.com/user/KurzweilTutorials](http://www.youtube.com/user/KurzweilTutorials)

**Chapter 1 Introduction ..... 7**

Key Features ..... 7

**Chapter 2 Getting Started ..... 8**

Setting Up the CUP P1 (CUP G1) ..... 8

– Box Contents ..... 8

– Plugging in the Power ..... 8

– Volume Adjustment ..... 9

**Chapter 3 Overview ..... 10**

Control Panel ..... 10

– VOLUME ..... 10

– EQ BASS ..... 10

– EQ TREBLE ..... 10

– RECORD ..... 10

– PLAY/STOP ..... 10

– DEMO ..... 10

– METRONOME ..... 10

– RHYTHM ..... 10

– EDU ..... 11

– FUNCTION ..... 11

– TEMPO / [-],[+] ..... 11

– PIANO RESET ..... 11

– LAYER ..... 11

– SPLIT ..... 11

– DUO ..... 11

– SOUND ..... 11

– BLUETOOTH ..... 11

I/O Ports ..... 12

– POWER ..... 12

– HEADPHONES ..... 12

– TO DEVICE ..... 12

– TO HOST ..... 12

– AUX IN ..... 12

– LINE OUT ..... 12

– PEDALS ..... 13

**Chapter 4 Details ..... 14**

– POWER ..... 14

– VOLUME ..... 14

– EQ BASS (BASS) ..... 14

– EQ TREBLE (TREBLE) ..... 14

– RECORD ..... 14

– PLAY/STOP ..... 14

– DEMO ..... 14

– METRONOME ..... 15

– RHYTHM ..... 16

– EDU ..... 17

– FUNCTION ..... 18

– LAYER ..... 20

– SPLIT ..... 21

– DUO ..... 22

– SOUND SELECT ..... 23

– SOUND LIST ..... 23

– PIANO RESET ..... 24

– BLUETOOTH ..... 24

– SETTING ..... 25

**Chapter 5 Appendix**

A. (MIDI Implementation Chart) ..... 28

B. (Assembly Instructions) ..... 28

**Specifications ..... 29**

Thank you for purchasing the KURZWEIL CUP P1 (CUP G1). We are certain you will enjoy many hours exploring its features and beautiful sounds.

This manual explains how to use the CUP P1 (CUP G1).

## Key Features

---

- 88 Fully-Weighted, Hammer-Action Keys
- 256 Note Polyphony
- 28 Preset Voices
- USB MIDI, USB Audio Function
- Easy and Intuitive Controls
- Bluetooth 5.2

## Setting up the CUP P1 (CUP G1)

---

### Box Contents

---

The components provided when purchasing CUP P1 (CUP G1) are as follows.

- CUP P1 (CUP G1) keyboard + stand with 3 pedals
- Headphone holder
- Bench
- DC Power Adapter
- Warranty Card

If you are missing any of the above, please contact your KURZWEIL dealer.

### Plugging in the Power

---

The CUP P1 (CUP G1)'s power is supplied by a DC power adapter.

Connect the power adapter to the DC jack on the rear panel of the CUP P1 (CUP G1).  
Then connect the power cord to an AC outlet.

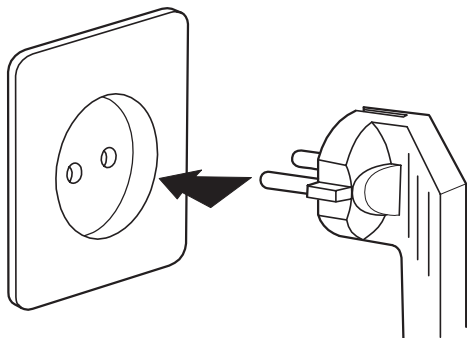

※ The shape of this plug differs depending on locality.

Press the power button on the front panel to turn the power on. When powered on, the front panel lights up.



**CAUTION :** Please use the supplied DC power adapter. (12V, 2A center-tip positive)  
Using the wrong DC Power adapter may cause damage to the product.  
If the adapter is damaged or lost, please contact your KURZWEIL dealer.

---

**Volume Adjustment**

---

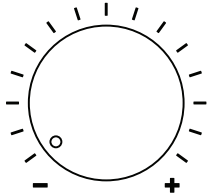

Before turning on the CUP P1 (CUP G1), please set the volume to its minimum value (all the way to the left). The main volume knob is located on the left side of the control panel. Turn it clockwise to increase the volume; turn it counterclockwise to decrease the volume. For a generally comfortable playing level, set the knob to its middle position.

# Chapter 3 CUP P1 (CUP G1) Overview

## Control Panel

---

### Left Side

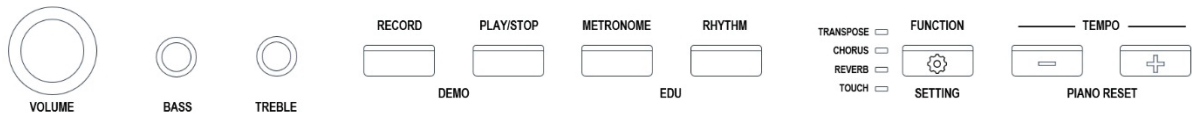

### Right Side

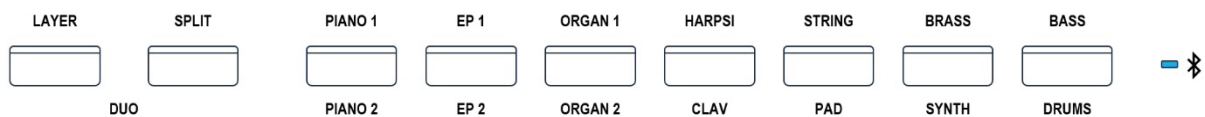

### VOLUME

---

Use the [VOLUME] knob to set the sound system's loudness level.

### BASS

---

Use the [BASS] knob to adjust the sound system's low frequencies.

### TREBLE

---

Use the [TREBLE] knob to adjust the sound system's high frequencies.

### RECORD

---

Controls the recording of user songs.

### PLAY/STOP

---

Controls the playback of EDU song and user-recorded songs.

### DEMO

---

Plays a demo song.

### METRONOME

---

Used to set the metronome pattern and tempo.

### RHYTHM

---

Used to set the Rhythm pattern and tempo.

---

**EDU**

---

Enter EDU mode for practice.

---

**FUNCTION**

---

Access the Function list (Transpose, Chorus, Reverb, Touch) or Setting mode.

---

**TEMPO / [-], [+]**

---

Change the metronome Tempo, select sound presets and alter the values of menu parameters.

---

**PIANO RESET**

---

Used to quickly move to voice 1.

---

**LAYER**

---

Combines two different voices across the keyboard, allowing you to play both voices as one.

---

**SPLIT**

---

Splits the keyboard into two regions, allowing you to play a different voice in each hand.

---

**DUO**

---

Divides the keyboard into two identical sections to support two different players, performing in tandem.

---

**SOUND Buttons**

---

7 Sound buttons for voice selection.

---

**BLUETOOTH**

---

The LED lights up when the CUP P1(G1) and an external device are connected.

## I/O PORTS (CUP P1, CUP G1)

---

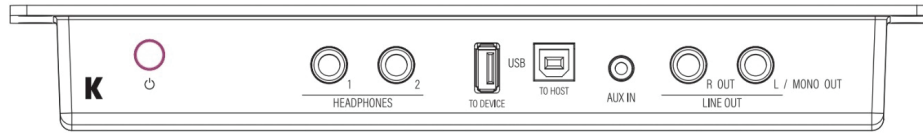

### POWER Button

---

Turn on and off CUP P1 (CUP G1).

### HEADPHONES

---

There are two 1/4" headphone jacks on the left side of CUP P1 (CUP G1). Plugging in headphones provides privacy during practice. When you plug headphones into either of the headphone jacks, the CUP P1(CUP G1)'s internal speakers will be muted (default behavior). (adjustable using the Speaker Setting in Setting mode, see pg 27 for details).

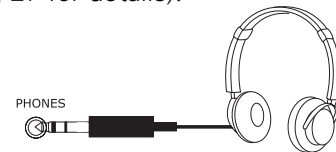

### TO DEVICE

---

Connect a USB thumb drive to update the firmware.

### TO HOST

---

The CUP P1 (CUP G1) can serve as a USB AUDIO card, MIDI controller or MIDI sound module.

### AUX IN

---

Connect an external audio device to the 1/8" input to listen to it through the CUP P1 (CUP G1)'s speakers or headphone jacks.

### LINE OUT [R] [L/MONO]

---

Connect the CUP P1 (CUP G1) to an external sound system, recorder, amplifier, etc.

---

## PEDALS

---

Please check the assembly guide regarding connections of the pedal unit.

### Damper (Right)

The damper pedal performs the same function as the damper pedal on an actual acoustic piano, letting you sustain the sound of the notes being played after releasing your fingers from the keys. The CUP P1 (CUP G1) offers half-damper pedal functionality. This allows you to control the duration of the sustain based on how long you depress the sustain pedal.

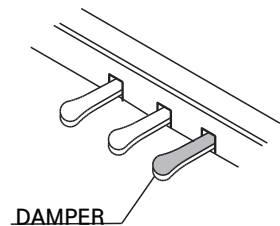

### Sostenuto (Center)

The sostenuto pedal also allows you to sustain notes but it works a little differently compared to the damper pedal. If you play a note or chord on the keyboard and press the sostenuto pedal while the notes are held, those notes will be sustained as long as the pedal is held. All subsequently played notes will not be sustained.

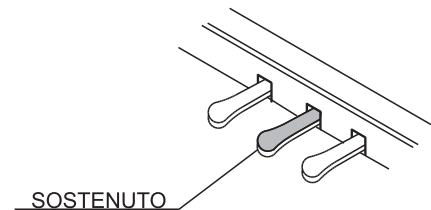

### Soft (Left)

The soft pedal on an acoustic piano changes the character of the sound, making it softer and quieter. The soft pedal on your piano does exactly the same. Press the soft pedal when you need to play passages that require extreme pianissimo.

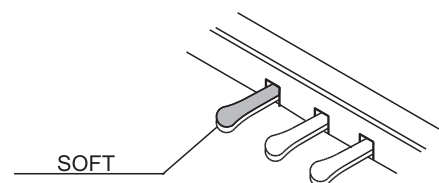

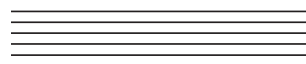

---

## POWER

---

Press the power button to turn on the CUP P1 (CUP G1). To conserve energy, the CUP P1 (CUP G1) will, by default, automatically shut off after 30 minutes of inactivity. You can adjust the auto-power off feature in Setting Mode (see pg 26).

---

## VOLUME

---

Control the main volume.

---

## EQ BASS

---

Use the BASS knob to adjust the level of low frequencies produced by the sound system.

---

## EQ TREBLE

---

Use the TREBLE knob to adjust the level of high frequencies produced by the sound system.

---

## RECORD

---

Press the [RECORD] button and start playing. The [RECORD] button light will blink and recording will begin when you touch the piano keys. To stop recording, press the [RECORD] button again.

---

## PLAY

---

To listen to the recorded song, press the [PLAY] button. The button LED will blink and the song will play back.

---

## DEMO

---

The CUP P1 (CUP G1) contains 7 demo songs. To listen to a demo, press the [RECORD] and [PLAY] buttons simultaneously. The [-] / [+] buttons will both light white and the first demo will begin to play.

Use the [-] / [+] buttons to select which demo to play.



To end demo song playback, press the [RECORD] and [PLAY] buttons together, simultaneously.

## METRONOME

Press the [METRONOME] button to activate. The [METRONOME] will start, the button will flash blue and the [-] / [+] buttons will light solid blue. The speed at which the [METRONOME] button flashes corresponds to the current tempo.

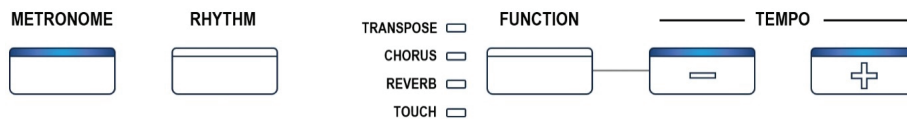

### METRONOME Tempo

You can adjust the [METRONOME] speed using the [-] / [+] buttons. The tempo range is from 20 to 280 (BPM).

### METRONOME Time Signature

To access the Time Signature setting, hold the [METRONOME] button for 2 seconds then release. The button's color will change from blue to red.

The screen displays the current time signature selection. Use the [-] / [+] buttons to select a different time signature: 1/4, 2/2, 2/4, 3/4, 3/8, 4/4, 5/4, 6/4, 6/8, 7/8, 9/8, 12/8

If the [-] / [+] buttons are not used for two seconds, the screen will revert back to the Tempo adjustment display and the button color will change back to blue.

### METRONOME Volume Control

The volume of the metronome can be adjusted through [SETTING] mode. For details, see the [SETTING] section found later in this manual.

To stop the METRONOME, press the [METRONOME] button again.

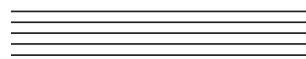

## RHYTHM

To play a backing rhythm, press the [RHYTHM] button. The button light will flash green and the first rhythm will begin playback. The speed at which the [RHYTHM] button flashes corresponds to the current Tempo. The [-] / [+] buttons will also illuminate green.

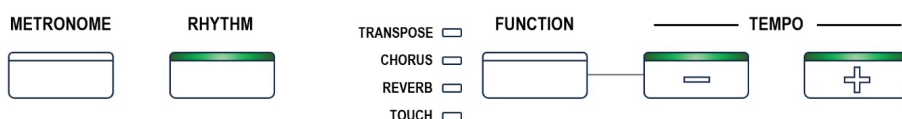

### RHYTHM Tempo Control

While a rhythm is playing, you can adjust the playback speed with the [-] / [+] buttons. The tempo range is from 20 to 280 (BPM).

### RHYTHM Selection

To select another rhythm, press and hold the [RHYTHM] button for 2 seconds then release. The color of the button will change from green to red and the screen will display the current rhythm. Use the [-] / [+] buttons to select a different rhythm.

If the [-] / [+] buttons are not used for two seconds, the screen will revert back to the default Tempo adjustment display and the button color will change back to green.

### RHYTHM Volume Control

The volume of the rhythm can be adjusted through SETTING mode. For details, see the SETTING section found later in this manual.

To stop the RHYTHM, press the [RHYTHM] button again.

## EDU Mode

Press the [METRONOME] and [RHYTHM] buttons simultaneously to access the built-in practice songs. When entering EDU mode, the [METRONOME] and [RHYTHM] buttons flash at the same time. The speed at which the buttons flash corresponds to the current Tempo. To play a practice song, press the [PLAY] button.



### EDU Song Tempo Control

While a practice song is playing, you can adjust the tempo using the [-] / [+] buttons. The tempo range is from 20 to 280 (BPM).

### EDU Song Select

To select different practice songs, hold the [PLAY] button for 2 seconds then release. The [PLAY] button will turn red indicating the function is activated. Use the [-] / [+] buttons to select another practice song.

If the [-] / [+] buttons are not used for two seconds, the screen will revert back to the Tempo adjustment display and the button color will change back to white.

### EDU Song Practice

EDU mode allows you to practice the left and right hands separately.

To practice the left hand, press the [METRONOME] button. This will silence playback of the left-hand part (red). EDU mode will play the right-hand part.

To practice the right hand press the [RHYTHM] button. This will silence playback of the right-hand part (red). EDU mode will play the left-hand part.

Press the [METRONOME] and [RHYTHM] buttons simultaneously to exit EDU mode altogether.

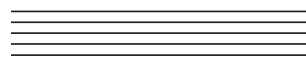

**FUNCTION**

The Function menu contains four adjustable sound parameters: Transpose, Chorus, Reverb and Touch.

Press the [FUNCTION] button to access the menu. Repeated presses of the [FUNCTION] button will cycle you through the list of parameters, top to bottom (note the LED indicator highlighting the chosen parameter). Use the adjacent [-] / [+] buttons to adjust the selected parameter.

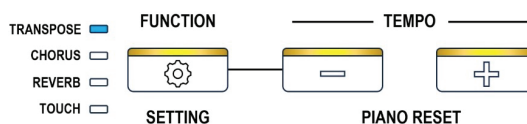

**Transpose**

Press the [FUNCTION] button to select Transpose, the first parameter in the list. Use the [-] / [+] buttons to change the Transpose value (- 12 ~ + 12). Press the [-] and [+] buttons simultaneously to restore the default value.

**Chorus**

Press the [FUNCTION] button to select Chorus, the second parameter in the list. Use the [-] / [+] buttons to change the Chorus amount (0 ~ 127). Press the [-] and [+] buttons simultaneously to restore the default amount.

**Reverb**

Press the [FUNCTION] button to select Reverb, the third parameter in the list. Use the [-] / [+] buttons to change the Reverb amount (0 ~ 127). Press the [-] and [+] buttons simultaneously to restore the default amount.

### Touch

Press the [FUNCTION] button to select Touch (touch sensitivity), the fourth parameter in the list. Use the [-] / [+] buttons to select between seven touch settings:

Soft 1, 2 / Normal 1, 2, 3 / Hard 1, 2.

Press the [-] and [+] buttons simultaneously to restore the default setting, Normal 2.

### Function Memory

Function menu settings will be retained even with the power off.

### PIANO RESET

To restore all Function settings to their factory defaults, first exit all feature modes (Function, Layer, Split, Metronome, Rhythm, Demo, Edu) then press the [-] / [+] buttons together simultaneously (PIANO RESET).

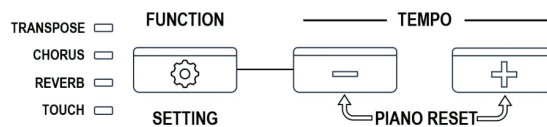

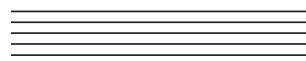

---

### LAYER Mode

---

Layer mode allows you to play two different sounds simultaneously across the entire keyboard. Press the [LAYER] button to enable Layer mode. When in Layer mode, the [-] / [+] buttons will both be lit. The default layer sound is Strings.

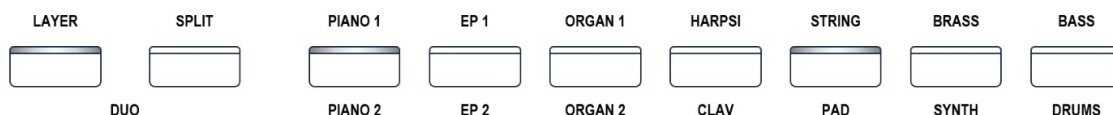

To change the Layer sound, press any sound button.

#### LAYER Volume Control

Press the [-] or [+] button, as needed, to adjust the layer volume (0~127). When the volume is modified, the [-] or [+] button will turn red. Press the [-] / [+] buttons simultaneously to restore the default layer volume setting.

#### LAYER Octave Control

To alter the octave that the layer sounds in, hold the [LAYER] button for 2 seconds then release. The light turns red and octave control is activated. Next, press the [-] or [+] button to adjust the octave for the layer. (-2 / +2)

When the octave is modified, the [-] or [+] button flashes red. Press the [-] / [+] buttons simultaneously to restore the default octave setting.

Press the [LAYER] button two times to exit Layer mode.



## SPLIT Mode

Split mode allows you to play two different sounds on the keyboard, one in the left hand and one in the right. Press the [SPLIT] button to enable Split mode. When in Split mode, the [-]/[+] buttons will both be lit. The default split sound is Bass.

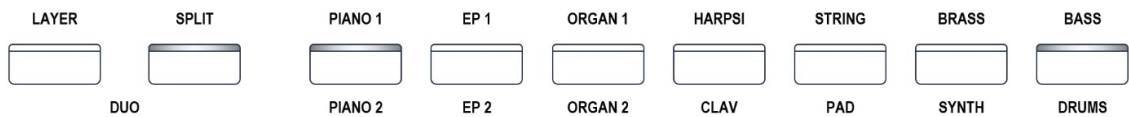

To change the SPLIT sound, press any sound button.

### Split Volume Control

Press the [-] or [+] button to adjust the Split volume (0–127). If the volume is modified, the [-] or [+] button flashes red. Press the [-] / [+] buttons simultaneously to restore the default volume levels.

### Split Octave Control

Hold the [SPLIT] button for 2 seconds then release. The light turns red and octave control is activated. Next, press the [-] or [+] button to change the octave (+/- 2). When the octave is modified, the [-] or [+] button flashes red. Press the [SPLIT] button again to return to the Split volume display.

### Split Point

Hold the [SPLIT] button 2 seconds. The light will turn red. Press any piano key to set the desired split point. Once set, you will return to the Split volume display.

Press the [SPLIT] button once more to exit Split mode.

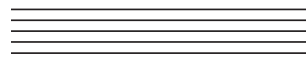

---

### Layer and Split Control Memory

Layer and Split settings will be retained even with the power off. To restore the default Layer and Split control values, press the -/+ buttons simultaneously.

### DUO Mode

---

Press the [LAYER] and [SPLIT] buttons simultaneously to enable Duo mode.

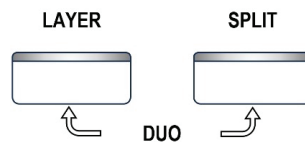

Duo mode facilitates two-player, side-by-side, performance and divides the keyboard as follows:

Left Side: A-1 ~ C3

Right Side: C#3 ~ C7





Press the [LAYER] and [SPLIT] buttons simultaneously to exit Duo mode.



## SOUND Select Mode

The CUP P1 (CUP G1) has a total of 7 sound category selection buttons. Each button has assigned to it a total of four related sounds (28 presets in total, 7x4).

### Sound List

Order	Button Colors	Button 1	Button 2	Button 3	Button 4	Button 5	Button 6	Button 7
1		PIANO 1	EP 1	ORGAN 1	HARSI 1	STRING 1	BRASS 1	BASS 1
2		PIANO 2	EP 2	ORGAN 2	HARSI 2	STRING 2	BRASS 2	BASS 2
3		PIANO 3	EP 3	ORGAN 3	CLAV 1	PAD 1	SYNTH 1	DRUMS 1
4		PIANO 4	EP 4	ORGAN 4	CLAV 2	PAD 2	SYNTH 2	DRUMS 2

### Sound Select

There are 2 ways to select a sound:

- By repeatedly pressing a given Sound button you can cycle through each of the four available presets within that group. With each tone change, the button will change color and the corresponding preset name will be shown in the LCD.

(WHITE → GREEN → YELLOW → RED)



- You can also navigate through the presets using the [-] / [+] buttons.



Press any sound button for 2 seconds to return to the first sound of the given category.

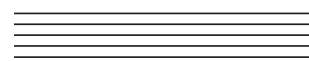

---

### Sound Button Memory

Sound selection choices will be retained even with the power off. To restore all Sound categories to their default selections, press the [-] / [+] buttons simultaneously.

### PIANO RESET

---

To restore all settings to their factory defaults, first exit all feature modes (Function, Layer, Split, Metronome, Rhythm, Demo, Edu) then press the [-]/[+] buttons together simultaneously (PIANO RESET).

### Bluetooth Connection

---

Bluetooth is enabled by default. The icon will automatically light when pairing with a nearby smart device is completed.

## SETTING

Setting mode provides access to various system parameters. To enter Setting mode, hold the [FUNCTION] button for two seconds. Both the [FUNCTION] and [PLAY] buttons will flash.

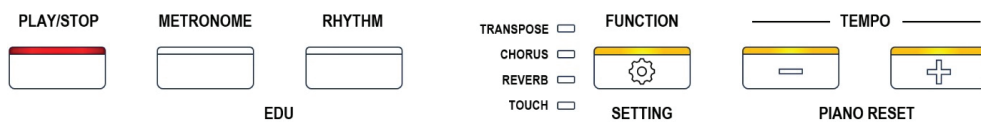

### Setting Selection and Adjustment

- 1) Press the [PLAY/STOP] button to advance through the various setting pages.
- 2) Use the [-] / [+] buttons to adjust the value of the selected setting.

#### Metronome Volume

Adjust the Metronome Volume using the [-], [+] buttons (Range: 0-127)

#### Rhythm Volume

Adjust the Rhythm Volume using the [-], [+] buttons (Range: 0-127)

#### Reverb Type

Select the Reverb Type using the [-], [+] buttons.

01	02	03	04	05	06
Hall1	Hall1	Room1	Room2	Room3	Off

#### Chorus Type

Select the Chorus Type using the [-], [+] buttons.

01	02	03
Chorus1	Chorus2	Off

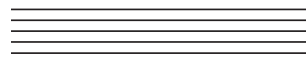

---

### LOCAL On/Off

When working with an external sequencer/DAW, it is important to disable the keyboard's 'local control' to avoid doubled notes.

- On : Local allows the CUP P1 (CUP G1) to trigger itself normally. Local is On by default.
- Off : The CUP P1 (CUP G1) no longer triggers itself directly and only transmits/receives via USB MIDI.

### Auto Close

With Auto Close enabled, the CUP P1 (CUP G1) will shut down automatically. Select an interval of 10, 30 or 60 minutes. Auto Close off can also be disabled (Off).

Off / 10 minutes / 30 minutes / 60 minutes

### Tune

To fine-tune the CUP P1 (CUP G1), use the [-] and [+] buttons to adjust the pitch ( ±100 cents). To reset the factory tuning (0 cents), press the [-] and [+] buttons together, simultaneously.

### BLUETOOTH

Activation of Bluetooth mode.

On/Off (Default: On)

### **MIDI Panic**

MIDI Panic is useful for silencing any stuck notes that may occur when working with external MIDI devices.

### **MIDI Channel**

Select MIDI Channel

00~15 except 09 (Default : 00)

### **Speaker Setting**

- 1) Default : There are two different headphone inputs.  
When connecting to either headphone jack, the speakers will mute automatically.
- 2) Headphone mute : The headphone jacks will be muted and sound will only come from the speakers.
- 3) Speakers Mute : The speakers will be muted and sound will only be heard via the headphone connections.
- 4) Both : Regardless of headphone usage, sound will be heard from both the speakers and headphones.

### **Aux Bluetooth Volume**

Bluetooth aux-in volume control (range: 0-127)

### **Reset**

Invoking this parameter resets the CUP P1 (G1) back to its factory default settings.

To exit Setting mode, press the [FUNCTION] button again.

Functions		Transmitted	Recognized	Remarks
<b>Basic Channels</b>	Default Changed	1-16 1-16	1-16 1-16	*Up to 3 channels simultaneously
<b>Mode</b>	Deraura Messages Altered	Mode 3 Yes *****	Mode 3 No No	
<b>Note Number</b>	True voice	0-127 *****	0-127	
<b>Velocity Notes</b>	Note ON Note OFF	Yes Yes	Yes Yes	
<b>After Touch</b>	Key's Channels	No No	No No	
<b>Pitch Bend</b>		No	No	
<b>Control Change</b>		0-127	0.1,5,6,7,10,11,4 32,64,65,66,67,4 80,81,91,93,100,8 101,121	
<b>Program Change</b>	True #	0-127 *****	0-15	16
<b>System Exclusive</b>		Yes*	Yes*	*The controller will recognize and respond to GM Device inquiries. Master Tune supported. Master Volume supported.
<b>System Common</b>	Song Position Pointe Song Select Tune Request	No No No	No No No	
<b>System RealTime</b>	Clock Commands	No No	No No	
<b>Aux Messages</b>	All Sounds Off* Reset All Controllers Local ON/OFF* ALL Notes OFF Active Sensing System Reset	Yes Yes Yes Yes No No	Yes Yes Yes Yes Yes Yes	* The controller will responds to GM, but not piano voices,
<b>Notes</b>				

MIDI Channel Modes		
	POLY OFF	MONO ON
OMNI ON	Mode 1	Mode 3
OMNI OFF	Mode 2	Mode 4

# Specifications

Keyboard	88 Fully-Weighted Hammer Action Keys (H1 Ivory)
Polyphony	256
Sound	28
Performance Control	Layer, Split, Duo
Record	1 Track, 1 Song
Transpose	Full transposition to any key, $\pm$ 1 octave
Tune	+/- 100ct
Metronome	Start, Stop, Time Signature, Tempo, Volume
Effect	Reverb, Chorus, EQ (Bass, Treble)
Demo	7 Song
USB	USB MIDI (16 channels) / Audio
Bluetooth	BT 5.2 MIDI & Audio
Display	LCD
Line In/Out	1/8" Aux In (Stereo) x 1, 1/4" unbalanced x 1
Headphone Out	2 Headphone outs (1/8", 1/4")
Pedal	3 pedals (soft ,sostenuto, sustain with half damper)
Amp	30W
Speakers	Speakers: 4 (2 woofers/ 2 tweeters)
Accessories	DC Power Adapter, Bench, Warranty Card, QR manual
Size	CUP P1: H 33.7" (85.6 cm) * D 20" (50.8 cm) * L 54.8" (139.3 cm) CUP G1: H 35" (88.9 cm) * D 29.5" (74.9 cm) * L 55.5" (141 cm)
Weight	CUP P1: 124.3 lb (56.4 Kg) CUP G1: 150 lb (68 Kg)
Power	DC Power adapter : 12V 2.0A

# Chapter 6 Assembly Instructions

## What's Included

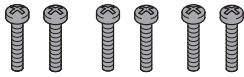

Piano Body Bolts (A) x 6



Back Panel Bolts (B) x 2

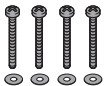

Back Panel Bolts (C) x 4

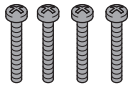

Pedal Board Bolts (D) x 4



Headphone Holder Bolts (E) x 4



Cable Clips (F) x 4



Headphone Holder

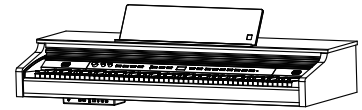

Piano

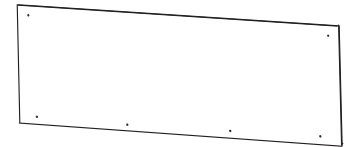

Back Panel

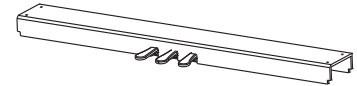

Pedal Board

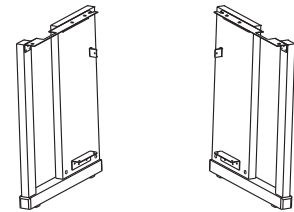

Legs (2)

## Attaching the Pedal Board

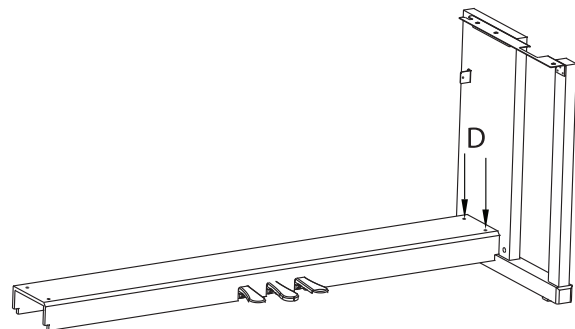
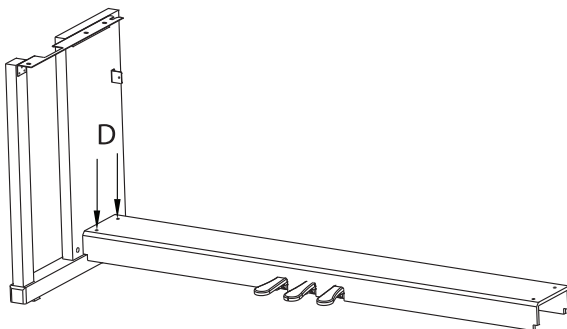

Starting with the right Stand Leg, align the holes in the Pedal Board with the holes in the Pedal Board Bracket as shown. Make sure that the pedals are facing towards the front of the Stand Legs. Thread two Pedal Board Bolts (D) through the Pedal Board and into the bracket. Repeat with the left Stand Leg and tighten all bolts fully.

## Attaching the Back Panel and Piano Body

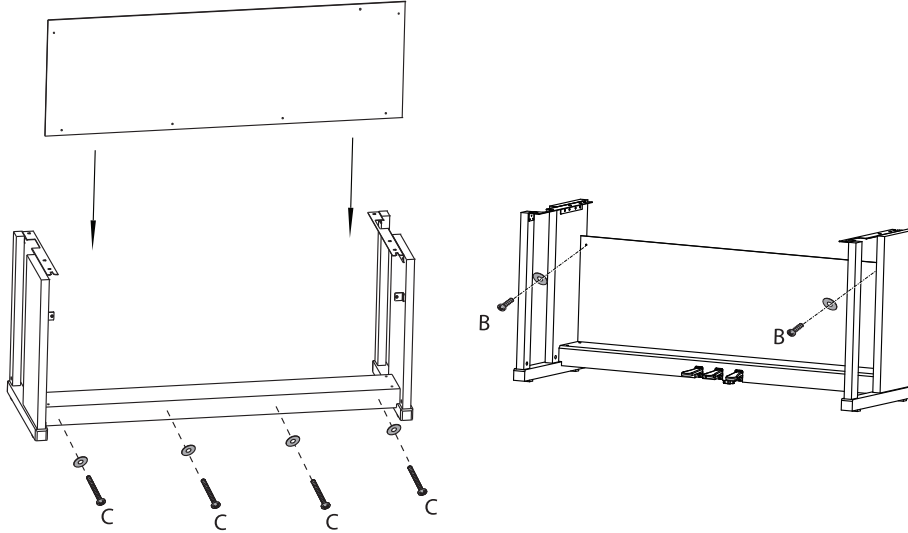

Using four Back Panel Bolts (C) with washers, and two Back Panel Bolts (B) with washers, attach the Back Panel to the stand.

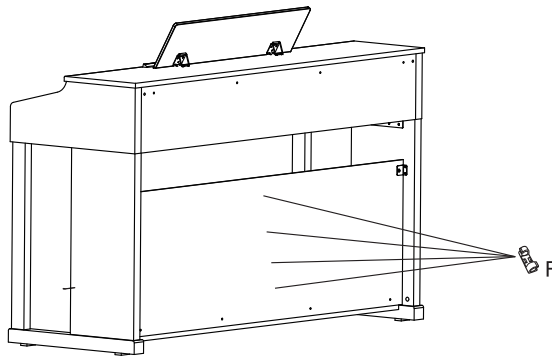

Attach four cable clips(F) to secure the cable.

Lift onto stand slide forward,

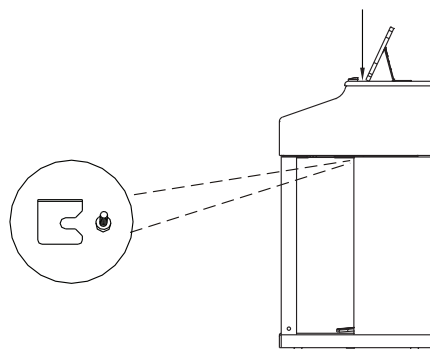

With help from another person, lift the piano onto the stand and slide forwards, pushing the guide rods on the bottom of the piano into the slots on the Stand Legs, as shown below. When lifting the piano onto its stand, be careful not to catch/trap hands or fingers.

**Securing the Piano Body**

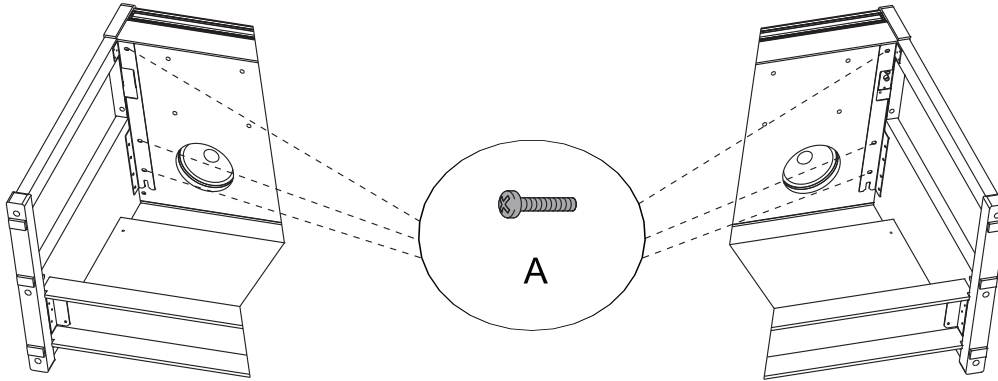

Finish attaching the piano to the stand by using the six Piano Body Bolts (A) to attach the bottom of the piano to its stand.

**Installing the Headphone Holder**

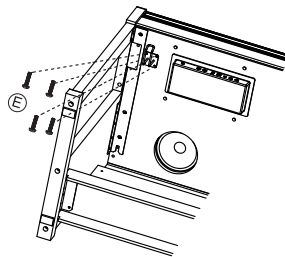

Headphone Holder Installation: Attach the headphone holder to the bottom left of the piano with the four Headphone Holder Bolts (E).

**Connecting the Pedal Cable and Power Supply**

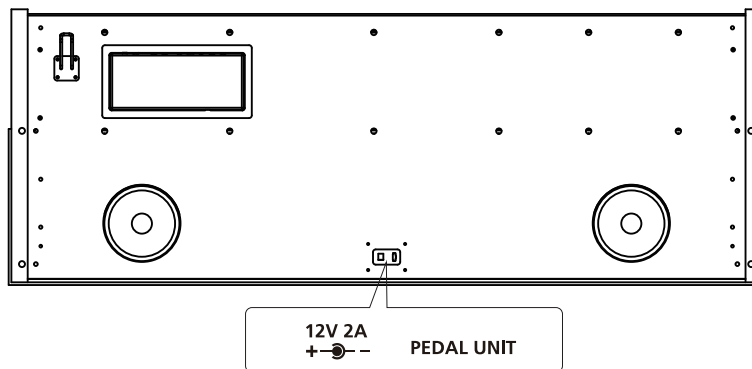

Attach the DC Adaptor and Pedal Cable into their connectors on the bottom of the piano as shown.

### Installation precautions for pedal

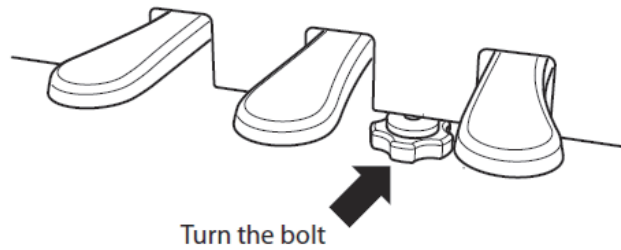

Turn the Pedal Support Bolt beneath pedals counter-clock until bolt firmly rests on the floor.

### Bench

A:  X4

B:  X4

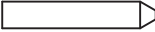
C:  X4

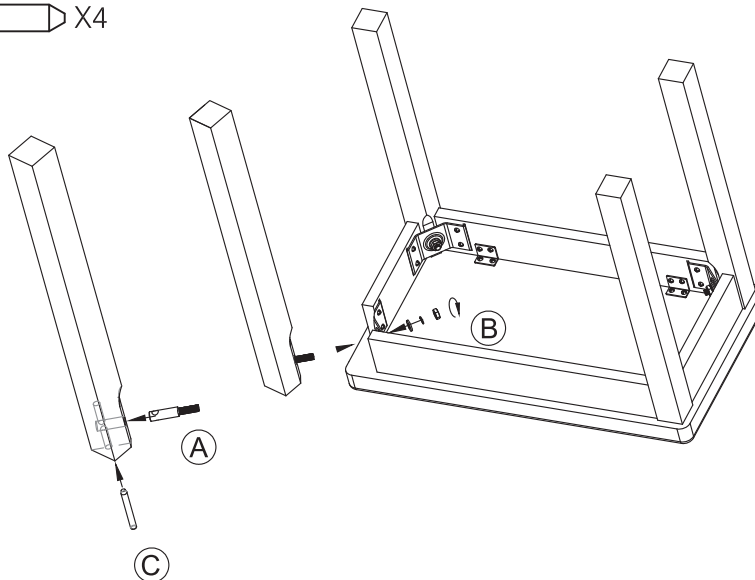

# KURZWEIL



<http://kurzweil.com>



[www.facebook.com/kurzweilhome/](http://www.facebook.com/kurzweilhome/)



<https://www.instagram.com/kurzweilmusic/>



[www.threads.net/kurzweilmusic](http://www.threads.net/kurzweilmusic)



[www.twitter.com/KurzweilMusic](http://www.twitter.com/KurzweilMusic)



[www.youtube.com/user/KurzweilTutorials](http://www.youtube.com/user/KurzweilTutorials)

HDC YOUNG CHANG