

KURZWEIL®

MPS 110/120

USER'S
MANUAL

English Manual

HDC YOUNG CHANG

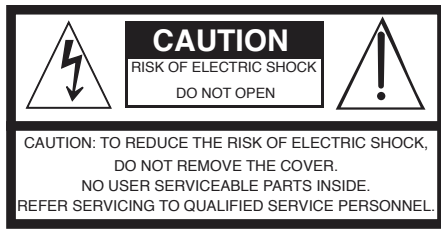

The lightning flash with the arrowhead symbol, within an equilateral triangle is intended to alert the user to the presence of uninsulated "dangerous voltage" within the product's enclosure that may be of sufficient magnitude to constitute a risk of electric shock to persons.



The exclamation point within an equilateral triangle is intended to alert the user to the presence of important operating and maintenance (servicing) instructions in the literature accompanying the product.

IMPORTANT SAFETY & INSTALLATION INSTRUCTIONS

INSTRUCTIONS PERTAINING TO THE RISK OF FIRE ELECTRIC SHOCK , OR INJURY TO PERSONS

WARNING: When using electric products, basic precautions should always be followed, including the following:

1. Read all the Safety and Installation Instructions and Explanation of Graphic Symbols before using the product.
2. This product must be grounded. If it should malfunction or break down, grounding provides a path of least resistance for electric current to reduce the risk of electric shock. This product is equipped with a power supply cord having an equipment-grounding conductor and a grounding plug. The plug must be plugged into an appropriate outlet which is properly installed and grounded in accordance with all local codes and ordinances.
DANGER: Improper connection of the equipment-grounding conductor can result in a risk of electric shock. Do not modify the plug provided with the product – if it will not fit the outlet, have a proper outlet installed by a qualified electrician. Do not use an adaptor which defeats the function of the equipment-grounding conductor. If you are in doubt as to whether the product is properly grounded, check with a qualified serviceman or electrician.
3. Do not use this product near water for example, near a bathtub, washbowl, kitchen sink, in a wet basement, or near a swimming pool, or the like.
4. This product should only be used with a stand or cart that is recommended by the manufacturer.
5. This product, either alone or in combination with an amplifier and speakers or headphones, may be capable of producing sound levels that could cause permanent hearing loss. Do not operate for a long period of time at a high volume level or a level that is uncomfortable. If you experience any hearing loss or ringing in the ears, you should consult an audiologist.
6. This product should be located so that its location or position does not interfere with its proper ventilation.
7. The product should be located away from heat sources such as radiators, heat registers, or other products that produce heat.

8. The product should be connected to a power supply only of the type described in the operating instructions or as marked on the product.
9. This product may be equipped with a polarized line plug (one blade wider than the other). This is a safety feature. If you are unable to insert the plug into the outlet, contact an electrician to replace your obsolete outlet. Do not defeat the safety purpose of the plug.
10. The power supply cord of the product should be unplugged from the outlet when left unused for a long period of time. When unplugging the power supply cord, do not pull on the cord, but grasp it by the plug.
11. Care should be taken so that objects do not fall and liquids are not spilled into the enclosure through openings.
12. The product should be serviced by qualified service personnel when:
 - A. The power supply cord or the plug has been damaged;
 - B. Objects have fallen, or liquid has been spilled into the product;
 - C. The product has been exposed to rain;
 - D. The product does not appear to be operating normally or exhibits a marked change in performance;
 - E. The product has been dropped, or the enclosure damaged.
13. Do not attempt to service the product beyond that described in the user maintenance instructions. All other servicing should be referred to qualified service personnel.
14. **WARNING:** Do not place objects on the product's power supply cord, or place the product in a position where anyone could trip over, walk on, or roll anything over cords of any type. Do not allow the product to rest on or be installed over cords of any type. Improper installations of this type create the possibility of a fire hazard and/or personal injury.

RADIO AND TELEVISION INTERFERENCE

WARNING: Changes or modifications to the instrument not expressly approved by Young Chang could void your authority to operate the instrument.

IMPORTANT: When connecting this product to accessories and/or other equipment use only high quality shielded cables.

NOTE: This instrument has been tested and found to comply with the limits for a Class B digital device, pursuant to Part 15 of the FCC Rules. These limits are designed to provide reasonable protection against harmful interference in a residential installation. This instrument generates, uses, and can radiate radio frequency energy and, if not installed and used in accordance with the instructions, may cause harmful interference to radio communications. However, there is no guarantee that interference will not occur in a particular installation. If this instrument does cause harmful interference to radio or television reception, which can be determined by turning the instrument off and on, the user is encouraged to try to correct the interference by one or more of the following measures:

- Reorient or relocate the receiving antenna.
- Increase the separation between the instrument and the receiver.
- Connect the instrument into an outlet on a circuit other than the one to which the receiver is connected.
- If necessary consult your dealer or an experienced radio/television technician for additional suggestions.

The normal function of this product may be disturbed by strong electro magnetic interference. If so, simply reset the product to resume normal operation by following the instruction manual. In case the function could not resume, please use the product in another location.

NOTICE

This apparatus does not exceed the Class B limits for radio noise emissions from digital apparatus set out in the Radio Interference Regulations of the Canadian Department of Communications.

AVIS

Le présent appareil numérique n'émet pas de bruits radioélectriques dépassant les limites applicables aux appareils numériques de la class B prescrites dans le Règlement sur le brouillage radioélectrique édicté par le ministère des Communications du Canada.

SAVE THESE INSTRUCTIONS

IMPORTANT SAFETY INSTRUCTIONS

1. Read these instructions.
2. Keep these instructions.
3. Heed all warnings.
4. Follow all instructions.
5. Do not use this apparatus near water.
6. Clean only with dry cloth.
7. Do not block any of the ventilation openings. Install in accordance with the manufacturer's instructions.
8. Do not install near any heat sources such as radiators, heat registers, stoves, or other apparatus (including amplifiers) that produce heat.
9. Do not defeat the safety purpose of the polarized or grounding-type plug. A polarized plug has two blades with one wider than the other. A grounding type plug has two blades and a third grounding prong. The wide blade or the third prong are provided for your safety. If the provided plug does not fit into your outlet, consult an electrician for replacement of the obsolete outlet.
10. Protect the power cord from being walked on or pinched, particularly at plugs, convenience receptacles, and the point where they exit from the apparatus.



11. Only use attachments/accessories specified by the manufacturer.
12. Use only with a cart, stand, tripod, bracket, or table specified by the manufacturer, or sold with the apparatus. When a cart is used, use caution when moving the cart/apparatus combination to avoid injury from tip-over.
13. Unplug this apparatus during lightning storms or when unused for long periods of time.
14. Refer all servicing to qualified service personnel. Servicing is required when the apparatus has been damaged in any way, such as power-supply cord or plug is damaged, liquid has been spilled or objects have fallen into the apparatus, the apparatus has been exposed to rain or moisture, does not operate normally, or has been dropped.
15. Allow adequate ventilation for the power adapter. Do not hide it under a carpet or behind a curtain or place it in an enclosed space where heat buildup can occur.

WARNING: To reduce the risk of fire or electric shock, do not expose this apparatus to rain or moisture.

Do not expose this equipment to dripping or splashing and ensure that no objects filled with liquids, such as vases, are placed on the equipment.

To completely disconnect this equipment from the AC Mains, disconnect the power supply cord plug from the AC receptacle.

Kurzweil International Contacts

Contact the appropriate Kurzweil office listed below to locate your local Kurzweil representative.

US Customers:

American Music & Sound
925 Broadbeck Dr #220
Newbury Park, CA 91320

Tel: 800-431-2609
Fax: 818-597-0411
Email: info@americanmusicandsound.com

Customers Outside the US:

Young Chang Co., LTD.

South Korea
Tel: +82 32 570 1000

www.ycpiano.co.kr
www.youngchang.com



WWW

www.kurzweil.com



support@kurzweil.com



www.facebook.com/kurzweilmusicsystems/



www.twitter.com/KurzweilMusic



www.youtube.com/user/KurzweilTutorials

Table of Contents

Chapter 1 Introduction

Primary Features	6
------------------------	---

Chapter 2 Getting Started

1. Setting Up the MPS110	7
– Carton Contents	7
– Power Connection	7
– Volume	8
– Headphone Jacks	8
– Music Rack Assembly	9
2. Quick Guide	10

Chapter 3 MPS110 Overview

1. Input/Output Panel	11
– Smart I/O	
– Line Out	
– Sustain Pedal	
– USB	
– Power Switch	
2. Control Panel Display	12
– Program Button	
– Bluetooth Button	
– Metronome/Rhythm Button	
– Set Button	
– Up/Down Buttons	
– Play/Stop Button	
– Recoding Button	

Chapter 4 MPS110 Details

1. Program Mode	13
2. Playing Demo Songs	13

3. Playing Metronome/Rhythm .	14
-------------------------------	----

4. Bluetooth Audio	14
--------------------------	----

5. Recoding/Play	16
------------------------	----

6. Settings.....	17
------------------	----

Chapter 5 Appendix

Specifications	18
----------------------	----

Congratulations on your purchase the Kurzweil MPS110.

You are certain to enjoy many hours exploring the variety of features as well as the beautiful preset Programs.

This manual introduces the MPS110 and MPS120. However, collectively, it is referred to as MPS110.

Primary Features

- MPS110 : 88-Note graded hammer-action keyboard with 3-point velocity sensor
- MPS120 : 88-Note graded hammer-action Wood keyboard with 3-point velocity sensor
- 256 Polyphony
- 24 Preset Kurzweil programs + 128 GM programs
- String Resonance, Damper Resonance, Key-off sample (only for piano program)
- 8 Metronome + 10 Drum patterns
- Bluetooth 5.0 Audio reception and remote control function
- USB MIDI and Audio Interface functions
- 24W digital amplifier and 4 Speaker sound system
- Two Headphone jacks
- Optional half-damper pedal (sold separately)

Setting Up the MPS110

Carton Contents

MPS110 carton packing list

- MPS110 instrument
- DC power Adapter and AC power cord
- Music Rack
- Sustain Pedal (switch type)
- Warranty Card
- MPS20 User's Manual (this manual)
- USB Cable, Smart Recoding Cable

If you are missing any of the above, please contact your Kurzweil dealer.

It is always a good idea to save the MPS110's carton, in case you need to ship it.

Power Connection

The MPS110's power is supplied by a DC power adapter.

Connect the power adapter to the DC jack on the rear panel of the MPS110.

Then connect the power cord to an AC outlet.

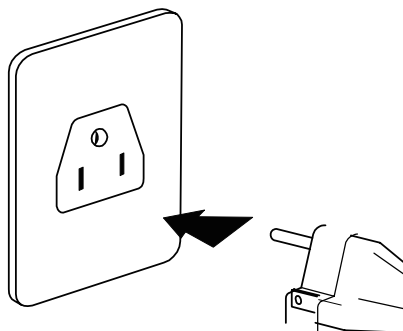

※ The shape of this plug differs depending on locale.



CAUTION : Please use the supplied DC power adapter. (15V,2.5A center positive)
Using the wrong DC power adapter may cause damage to the product.
If the adapter is damaged or the adapter is lost, please contact your KURZWEIL dealer.

Chapter 2 Getting Started

Volume

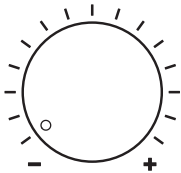

Before turning on the MPS110, it's always a good idea to set the volume to its minimum setting (all the way to the left). For a generally comfortable level of volume while playing, set the knob to its middle position.

The Volume Control is located on the left side of the control panel. Turn this knob from left to right to increase the volume.

Headphone Jacks

The MPS110 has two 1/4" headphone jacks conveniently located on the left front edge of the keyboard cabinet. Plugging in headphones provides privacy during practice.

The two jacks produce the same sound, so two people can play together or listen to music at the same time.

When you plug the headphones into the top headphone jack, the sound will be heard from the speakers and headphones. On the other hand, if you plug it into the bottom headphone jack, no sound will be heard from the speaker and sound will be heard from the headphone only.

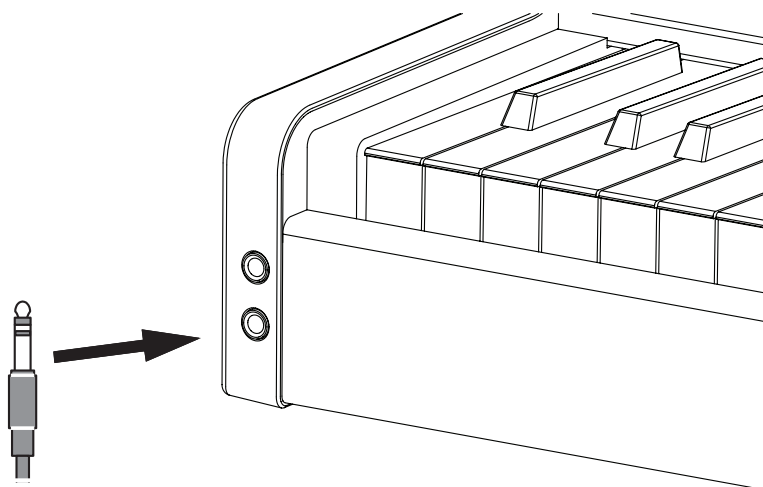

Music Rack Assembly

1. Prepare the Music Rack

Remove the protective plastic film from the acrylic music rack.

2. Attach the Music Rack

Remove the three screws located at the rear center of the MPS110. (See figure 1)

Place the music rack bracket in the center and fasten with the three removed screws. (See figure 2)



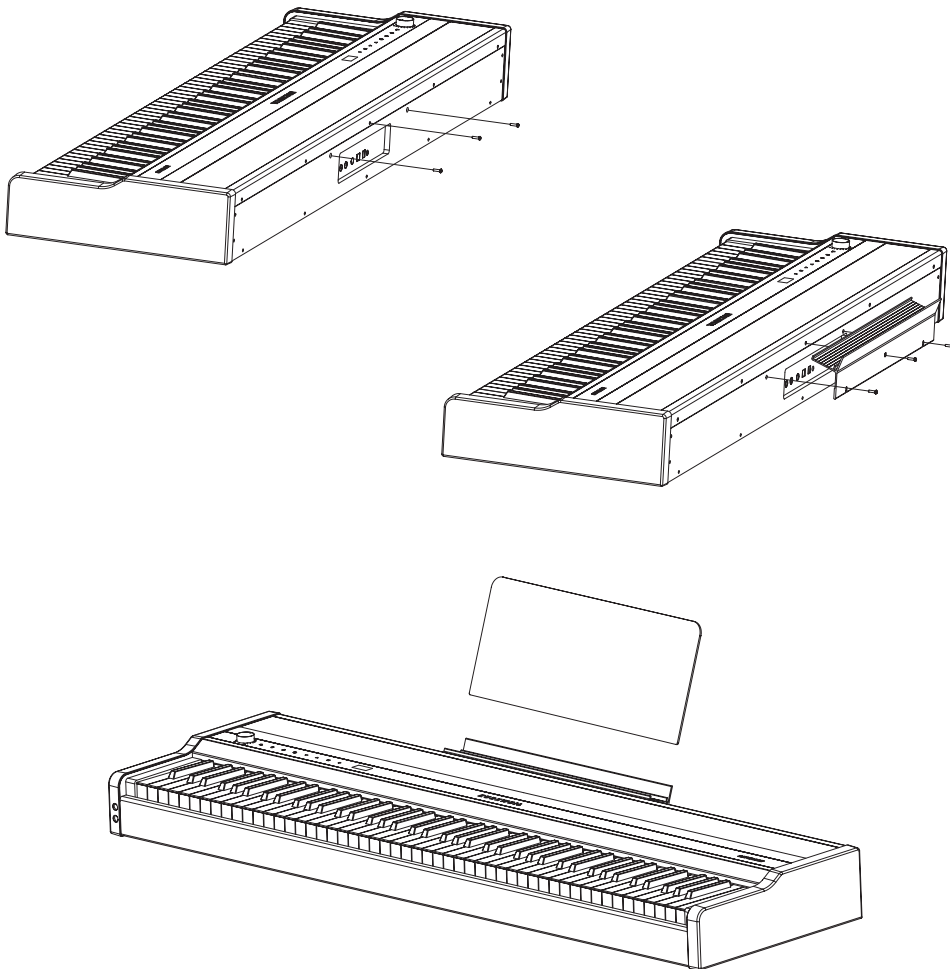



Insert the acrylic music rack into the music rack bracket.





Chapter 2 Getting Started

Quick Guide







Program selection []

1. When the MPS110 is turned on, the program selection [] button lights up and the first instrument program “9ft.Grand” is selected and can be played.
2. To select a different instrument program, press the [ ] buttons.
3. Press the [] button if you want to change the instrument program while using other functions such as [] or [].





Using Bluetooth audio function []

1. Press the [] button to activate the Bluetooth audio function.
2. Press the [] button to enter Bluetooth pairing mode. then, select the Bluetooth device marked KURZWEIL on your smartphone.
3. Select the music file you wish to play on your phone. You will hear the sound from the MPS110 speakers.





Playing a Metronome or Rhythm Track []

1. Press the [] button, the button will light up and the metronome plays immediately. While the metronome is playing, press the [ ] buttons to change the speed of the metronome.
2. Press and hold the [] button then press the [ ] buttons to select a rhythm.
3. Press the [] button again to stop playback of the metronome or rhythm track.

Recording []

1. When you press [] button, the [] button light blinks and recording is ready to start.
2. At this time, recording will start as soon as you start playing.
3. To stop recording, press the [] button
4. To listen to the recorded song again, press the [] button.

Play Demo songs

1. Press and hold [] button for 2 to 3 seconds to enter Demo Song mode.
2. Press the [] button to play the Demo songs. You can select another song by pressing the [ ] buttons.
3. To stop demo song playback, press the [] button.

Input / Output Panel

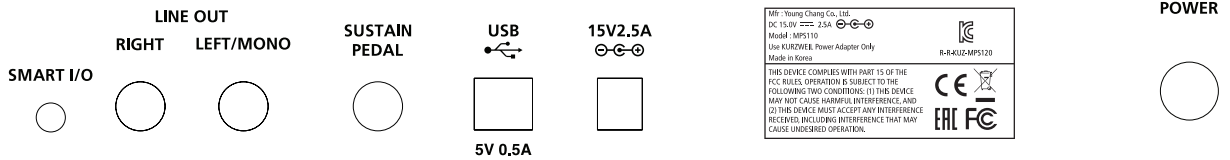

SMART I/O

This jack connects to the earphone jack of a smartphone using the dedicated cable included with your by MPS110. The MPS110 receives the stereo audio output from the smartphone and outputs it to the speakers or headphones. The sound played on the MPS110 can be transmitted as a mono audio signal to the smartphone and recorded on the smartphone.

Line Out

The line out jack on the MPS110 uses a 1/4" unbalanced cable to connect it to an external powered speaker, mixer or audio interface. When connected to Left/Mono only, a Mono audio signal is output and when connected to left and right simultaneously, a stereo audio signal is output.

Sustain Pedal

Connect the included KP-1 switch type sustain pedal or the optional KP-1H half-damper sustain pedal to the sustain pedal jack. (The MPS110 provides a half-damper function, so if you use the KP-1H or dedicated stand option, the decay of the note can be adjusted by how much the pedal is pressed)

USB

You can use USB MIDI and USB AUDIO functions by connecting to a PC or tablet using a USB cable. This allows the MPS110 to be used as a USB audio sound card, USB MIDI controller, or USB MIDI sound device.

Power Switch

Used to turn the MPS110 on or off.

Control Panel Display



Program Button

Enters Kurzweil program mode to change the program using [▼▲] buttons, Also enters GM program mode by pressing [] again.

Bluetooth Button

Activates the Bluetooth audio function and remote control of the Bluetooth transmitting device.

Metronome/Rhythm Button

Plays the metronome or rhythm patterns.

Settings Mode Button

Changes various settings of MPS110.

Up/Down Buttons

Used to select a program, setting, or rhythm.

Play/Stop Button





Use for demonstration songs, recorded songs, and Bluetooth device playback.

Recording Button

Use this to record your songs or to pair your Bluetooth device.





Selecting a Program

The program mode lets you select and listen to the various instrument sounds built into the MPS110.

1. When the MPS110 is turned on, the Program Select button [] button lights up, the first program "9ft. Grand" is selected, and Program Mode is active.
2. In Program Mode, you can select other programs by using the [ ] buttons.
3. In the MPS110's program mode, there is also a dual piano program that allows two people to practice the piano together. In addition, there are layer programs where two or more instruments play on the same key. Split programs play different instruments in different key ranges, such as "Piano and Bass".
4. Press the [] button once in Program Mode to select the 128 MIDI instrument General MIDI mode, the International MIDI standard. Press the [] button again the return to the Kurzweil program mode.
5. Even when using the metronome or Bluetooth function, pressing the piano button returns to program mode and different programs can be selected.
6. Press and hold the Program Select button to select the first voice, "9ft. Grand".

Playing Demo Songs





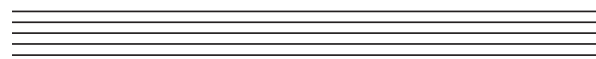



To demonstrate the sound of the MPS110, there are several demonstration songs.

1. Press and hold the [] button. The demo song mode is selected and pre-recorded songs may be is played.
2. When the currently playing song ends, it automatically plays the next song.
3. To change the demo song, press the [ ] buttons to select another song.
4. If you press the [] button during performance, demo song playback will stop.



Playing Metronome and Rhythm track

The metronome and rhythm function helps to improve accuracy of your beat when practicing the piano. This instrument has a variety of beats and rhythms.

1. When you press the [] button, the [] button will light.
Then the speed of the metronome is displayed on the screen and the metronome starts playing.
2. Use the [ ] buttons to change the speed of the metronome.
3. Press the [ ] buttons while holding down the [] button to select various metronomes and rhythms.
4. Press the [] button again to stop playback of the metronome or rhythm.
Below is a list of supported time signatures and rhythms.

Number	1	2	3	4	5	6
Time signature/ Rhythm Style	1/4	2/4	3/4	4/4	5/4	3/8

Number	7	8	9	10	11	12
Time signature/ Rhythm Style	6/8	12/8	Rock	Swing	Funky	Pop 90's











Number	13	14	15	16	17	18
Time signature/ Rhythm Style	Kick	Pop 80's	Blues	Jazz	Acid	Lounge

Bluetooth Audio

Bluetooth is a convenient function to connect a smartphone or tablet to the instrument wirelessly. Music of the smartphone then plays through the built-in speaker of the instrument.

1. When you press the [] button, it lights up. A brief message will be displayed on the screen, and the Bluetooth audio function will be activated.

2. To use Bluetooth, you must first connect the smartphone to the instrument. This is called "Pairing". Enter Bluetooth pairing mode by pressing the [●] button.
3. Select the device marked KURZWEIL in the Bluetooth settings of your smartphone. If the connection between the instrument and your smartphone is successful, you will hear a brief beep and pairing will be complete.
4. Once the pairing between the smartphone and the instrument has been successfully completed, you can listen to the music stored in your smart phone through the MPS110 built-in speaker.
5. The buttons and functions used in Bluetooth mode are as follows. However, some smart phone applications may not support the control function.

BUTTON	FUNCTION	EXPLANATION
	Enter to program selection	while using the Bluetooth mode, press the [] button to enter the Program mode. However, You must turn off the [] button before entering the Program mode.
	Enable Bluetooth feature	In program mode, the Bluetooth function is activated. In Bluetooth mode, it returns to program mode.
	Change song	Select the next or previous song on your smartphone.
	Volume Control of Bluetooth	Hold down the [] button and press the [] buttons to adjust the volume of your smartphone.
	Play and Stop the current song	Play or Stop the currently selected song on your smartphone.
	Enter the pairing mode	Enter the pairing mode for connecting the instrument to the smartphone.
Volume Knob	Master volume	The bluetooth volume and the Program mode volume are adjusted simultaneously.





Recording / Play

The recording function allows you to record and play your performance.

1. When you press the [●] button in Program mode, the [●] button will blink, and recording will be ready to start (record ready state).
2. If you want to cancel the recording function, press the [●] button again.
If you press it again before recording starts, the record button goes out and the recording function is canceled.
3. If you start playing in the recording ready state, the [▶] button lights up and recording starts (Notice: once recording starts, all previously recorded data will be erased).
4. To stop recording, press the [●] button. This will turn off the [▶] button and the [●] button, and recording will end.
5. To listen to the recorded song, press the [▶] button. The [▶] button lights up and the recorded song is played back. After playback is complete, the [▶] button will go out.
6. To delete a recorded song, hold down the [●] button and press the [▶] button. You will be informed on the screen that the recorded song has been deleted.
7. To record with a rhythm, press the [🎵] button while in record ready state. This will start the recording with the rhythm after two countdown measures of the rhythm.
However, in order to use this function, a rhythm must be selected in the metronome mode, not the metronome. The metronome beat cannot be recorded.

Settings

The Settings function is for setting detailed functions of the instrument so the user can play the instrument more professionally.

1. Press the [] button to enter the settings mode.
2. You can select the setting item (parameter) with [] or [] button, and you can change the value of the currently selected item with [ ] buttons.

SETTING ITEM	EXPLANATION
Transpose	The Transpose parameter allows you to adjust the overall pitch of the keyboard up or down in semitone intervals. Range: -12~12 semitones (-1~1 octave)
Tune	This parameter allows you to adjust the tuning in cents, Range : -100~100.
Auto Power	This function turns the power off automatically. This saves energy by turning the instrument off automatically after a set period of time when the instrument is not in use. The range is None, 15 minutes, 30 minutes, 1 hour, 2 hours.
Local Control	If you use your MPS110 with an external sequencer or computer, turn this setting to OFF.
Touch	Use this parameter to adjust the keyboard touch sensitivity to your playing technique.
Panic	Send All Notes Off MIDI message to any connected MIDI instruments.
Reverb Preset	Select the reverb type. (only for GM mode)
Reverb Amount	The Reverb level parameter controls the level of the reverb effect used by GM Programs.(only for GM mode)
Chorus Preset	Select the chorus type. (only for GM mode)
Chorus Amount	The Chorus level parameter controls the level of the chorus effect used by GM Programs. (only for GM mode)
Reset	<ol style="list-style-type: none"> 1. This function resets the MPS110 to the original factory default settings. 2. Select this item to initialize and press the [] button. 3. All user changes and recorded songs are erased.
Version	Displays software version

Specifications

Keyboard	MPS110 : LK-M400GH + 3S with 3-point-velocity sensor, GH MPS120 : LK-M400W + 3S with 3-point-velocity sensor, GH
Display	128x64 Resolution 1.2" OLED
Polyphony	256
Factory Programs	24 Preset Kurzweil programs + 128 GM programs
Recorder	1 Track 1 Song
Metronome/Rhythm	8 Metronomes + 10 Drum rhythms
USB	MIDI/ Audio interface
Bluetooth	BT 5.0 Audio Reception and Remote control
Line In/Out	1/4" Unbalanced connectors (Left and Right), 1/8" Smart I/O
Headphone	Two 1/4" stereo connectors
Pedal	Sustain Pedal, Lower Unit Pedal (Soft, Sostenuto, Sustain)
Amplifier	12W X 2
Speaker	3" X 5" 2ea, 2" 2ea
Basic Accessories	Music Rack (Acrylic plate), Sustain Pedal (switch type)
Additional Accessories	Half damper sustain pedal, Dedicated stand (wooden) + LowerUnit pedal
Dimension	1320mm X 380mm X 130mm
Weight	MPS110 : 16.5Kg, MPS120 : 17.5Kg
Power	DC Power adapter : 15V , 2.5A

MEMO

KURZWEIL

HDC YOUNG CHANG

196, Bongsu-daero, Seo-gu,
Incheon, Korea