



*Mark 2*  
*Digital Piano*

## OWNER'S MANUAL

Please note that all Hal Leonard Corporation Music Sheets have been removed from this .pdf format manual so that it can be provided free and on-line avoiding any copyright infringement.

KURZWEIL MUSIC SYSTEMS  
AND Music Corp  
9501 Lakewood Drive, SW Ste. D  
Lakewood, Washington 98499  
(253)589-3200



**CAUTION**

**RISK OF ELECTRIC SHOCK DO NOT OPEN**



**CAUTION: TO REDUCE THE RISK OF ELECTRIC SHOCK, DO NOT REMOVE THE COVER. NO USER SERVICEABLE PARTS INSIDE. REFER SERVICING TO QUALIFIED SERVICE PERSONNEL.**

#### EXPLANATION OF GRAPHIC SYMBOLS



The lightning flash with the arrowhead symbol, within an equilateral triangle, is intended to alert the user to the presence of uninsulated "dangerous voltage" within the product's enclosure that may be of sufficient magnitude to constitute a risk of electric shock to persons.



The exclamation point within an equilateral triangle is intended to alert the user to the presence of important operating and maintenance (servicing) instructions in the literature accompanying the product.

## IMPORTANT SAFETY AND INSTALLATION INSTRUCTIONS

### INSTRUCTIONS PERTAINING TO THE RISK OF FIRE, ELECTRIC SHOCK, OR INJURY TO PERSONS

**WARNING**—When using electric products, basic precautions should always be followed, including the following:

1. Read all of the Safety and Installation Instructions and Explanation of Graphic Symbols before using the product.
2. Do not use this product near water—for example, near a bathtub, washbowl, kitchen sink, in a wet basement, or near a swimming pool, or the like.
3. This product, either alone or in combination with an amplifier and speakers or headphones, may be capable of producing sound levels that could cause permanent hearing loss. Do not operate for a long period of time at a high volume level or at a level that is uncomfortable. If you experience any hearing loss or ringing in the ears, you should consult an audiologist.
4. The product should be located so that its location or position does not interfere with its proper ventilation.
5. The product should be located away from heat sources such as radiators, heat registers, or other products that produce heat.
6. The product should be connected to a power supply only of the type described in the operating instructions or as marked on the product.
7. This product may be equipped with a polarized line plug (one blade wider than the other). This is a safety feature. If you are unable to insert the plug into the outlet, contact an electrician to replace your obsolete outlet. Do not defeat the safety purpose of the plug.
8. The power supply cord of the product should be unplugged from the outlet when left unused for a long period of time. When unplugging the power supply cord, do not pull on the cord, but grasp it by the plug.
9. Care should be taken so that objects do not fall and liquids are not spilled into the enclosure through openings.
10. The products should be serviced by qualified service personnel when:
  - A. The power supply cord or the plug has been damaged; or
  - B. Objects have fallen, or liquid has been spilled, into the product; or
  - C. The product has been exposed to rain; or
  - D. The product does not appear to be operating normally or exhibits a marked change in performance; or
  - E. The product has been dropped, or the enclosure damaged.
11. Do not attempt to service the product beyond that described in the user maintenance instructions. All other servicing should be referred to qualified service personnel.
12. **WARNING**—Do not place objects on the product's power supply cord, or place the product in a position where anyone could trip over, walk on, or roll anything over cords of any type. Do not allow the product to rest on or be installed over cords of any type. Improper installations of this type create the possibility of a fire hazard and/or personal injury.

## SAVE THESE INSTRUCTIONS

### ASSEMBLY INSTRUCTIONS

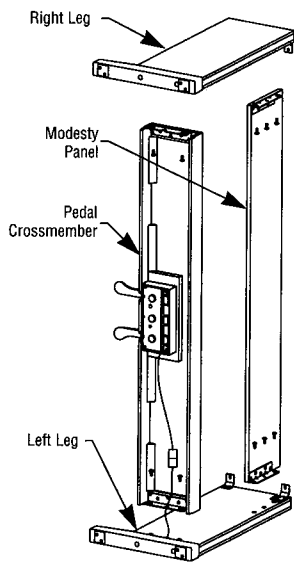

Figure 1

- Step 1**
- a) Place the Left Leg on a carpeted floor.
  - b) Place the Pedal Crossmember on end as shown in Figure 1. Align the two holes in the mounting bracket with the holes in the leg.
  - c) Take the cable that is at the base of the Left Leg and run it through the slot in the bracket, as shown.
  - d) Using a Phillips screwdriver, attach the Pedal Crossmember to the leg using two short screws.
  - e) Plug the Left Leg's cable into the Pedal Crossmember's cable.

**Step 3**

- a) Place the Right Leg on top of the Pedal Crossmember and Modesty Panel. Align all of the holes in the leg with the holes in the mounting brackets.
- b) Using a Phillips screwdriver, attach the Right Leg with the five remaining short screws.
- c) Place the assembled stand so that both feet are on the floor, as shown in Figure 2.

**Step 2**

- a) Place the Modesty Panel on end as shown in Figure 1. Align the three holes in the mounting bracket with the holes in the leg.
- b) Using a Phillips screwdriver, attach the Modesty Panel to the Left Leg using three short screws.

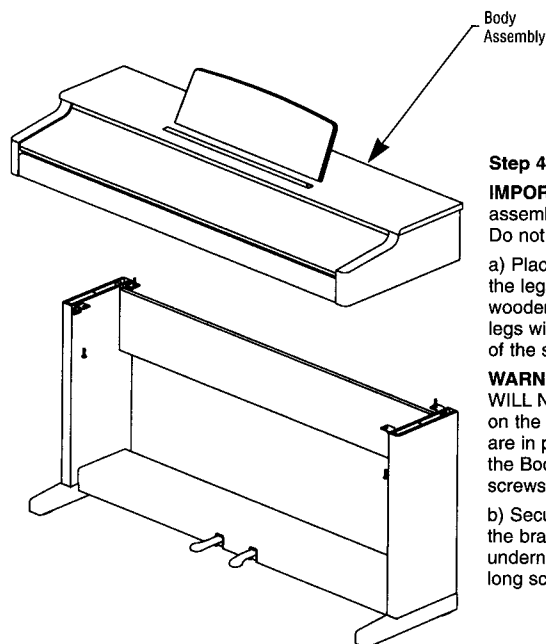

Figure 2

**Step 4**

**IMPORTANT:** This step of the assembly requires two people. Do not attempt to proceed alone.

- a) Place the Body Assembly onto the legs. Be sure to align the wooden pins at the back of the legs with the holes in the bottom of the side arms.

**WARNING:** The Body Assembly WILL NOT safely sit unsupported on the legs until all of the screws are in place. Have someone hold the Body Assembly while the screws are being secured.

- b) Secure the Body Assembly to the brackets on the legs from underneath the unit using the four long screws.

# KURZWEIL™

## *Music Systems*

### Mark 2 Digital Piano

- |   |   |    |   |
|---|---|----|---|
| 1 | Important Safety And Installation Instructions<br>Assembly Instructions     | 9  | Stereo/Monaural<br>Additional Information               |
| 2 | Radio And Television Interference<br>Young Chang Distributors               |    | Headphone Jack  |
| 4 | ABOUT THE MARK 2<br>Introduction<br>Care Of Your Instrument<br>Power        |    | Rear Panel<br>Power In<br>Audio Out<br>Audio In<br>MIDI |
| 5 | Demo<br>The Keyboard And Pedals<br>Sound Select<br>Digital Reverb & Effects | 10 | Service<br>Specifications                               |
| 6 | Master Volume<br>Reverb And Chorus<br>Recorder<br>Function                  | 11 | Music<br>Some Enchanted Evening                         |
| 7 | Demo<br>Tuning<br>Duet<br>Keyboard Operations                               | 14 | Bach Minuet   |
| 8 | Transpose<br>Velocity Sensitivity<br>MIDI Channel<br>Local Control          | 16 | Eleanor Rigby   |
|   |   | 18 | On Christ, The Solid Rock, I Stand                      |
|   |   | 19 | Air On The G String                                     |
|   |   | 22 | Can't Help Falling In Love                              |
|   |   | 24 | MIDI Implementation Chart                               |

Kurzweil is a product line of Young Chang Akki Co., Ltd., Seoul, Korea



Copyright © 1993, 1998 by HAL LEONARD CORPORATION  
International Copyright Secured All Rights Reserved

For all works contained herein:  
Unauthorized copying, arranging, adapting, recording or public performance is an infringement of copyright.  
Infringers are liable under the law.

# ABOUT THE MARK 2

---

## Introduction

Welcome to the Kurzweil Mark 2! The Mark 2 gives you simple, affordable access to Kurzweil's high-quality sound technology. The authentic digital representations of musical instrument sounds in the Mark 2 reproduce the finest details of the original sounds—from bass to treble and from soft to loud.

This manual serves as both a guided tour of the Mark 2 for the new owner and a reference for later use. The features of the instrument are discussed one at a time, and the songs included give you an opportunity to play the Mark 2 right away.

---

## CARE OF YOUR INSTRUMENT

Dust the Mark 2 with a soft dry cloth; DO NOT use aerosol sprays on or near it. Clean the keys with a soft damp (NOT wet) cloth, dampened in a solution of dish soap and water if necessary. NEVER use solvents such as alcohol or benzene.

NOTE: To avoid possible injury or electrocution, do not open up the Mark 2. There are no user-serviceable parts inside.

---

## POWER

The Mark 2 operates on DC power; a DC power adaptor is included with the instrument to connect it to an AC outlet. If you should move to another country, or if you should have any doubts about AC voltages, see your local Kurzweil dealer.

WARNING: Be sure the DC power adaptor is labeled "PD135-17." Use of any other power adaptor may damage your instrument or result in seriously degraded performance.

Before connecting the power supply, make sure the Power switch, underneath the keyboard on the left side, is OFF. One end of the power supply plugs into the Power In jack on the rear panel of the Mark 2; the other end plugs into an AC outlet. Connect it to the instrument first, then the AC outlet; then turn the Power switch ON. The Mark 2 is now ready to play. To make sure that you can hear the instrument, move the Master Volume slider to approximately the position shown:  This should provide a comfortable volume, which you can adjust if you wish.

The Mark 2 contains a built-in demonstration to acquaint you with the sounds and capabilities it possesses. To access this demonstration, first press the Select button in the Function section, which is located at the right end of the front-panel controls; the LED (light-emitting diode) above this button will illuminate. Then press the Play button, in the Recorder section, which has the word “Demo” printed beneath it. The LED above this button will also illuminate, the Function Select LED will go out, and the demonstration will begin playing.

The demonstration will stop automatically when it is finished. To stop it before it is finished, press the Play (Demo) button again. In either case, the LED above the Play (Demo) will go out.

The keyboard of the Mark 2 consists of 88 weighted keys, with an action designed to simulate the feel of an acoustic piano. Just as with an acoustic piano, the harder you press the keys of the Mark 2 (more precisely, the faster you strike them), the louder and brighter the resulting sound is. In technical terms, this is called “velocity sensitivity.” It makes the Mark 2 a truly expressive instrument. See page 8 for information on adjusting the velocity sensitivity to suit your preference. (NOTE: The Pipe Organ sounds purposely *isn't* velocity-sensitive, because real pipe organs aren't velocity-sensitive.)

In addition to the expressiveness offered by the keyboard, there are two pedals that provide you with further control over the sounds of the Mark 2. These pedals have the same functions as those on a grand piano:

- SUSTAIN. Pressing the right pedal causes notes to sustain even when you lift your fingers from the keys.
- SOFT. Pressing the left pedal generally causes notes to sound softer and more muted when they are played.

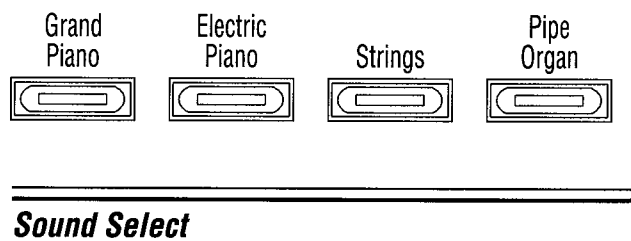

The Sound Select portion of the front panel contains buttons used for selecting from among the four different sounds available on the Mark 2. You select a sound by pressing the corresponding button. Any notes still sounding at the time you select a new sound will complete playing the original sound.

When you turn the Power switch ON, the Grand Piano sound is automatically active and ready to play.

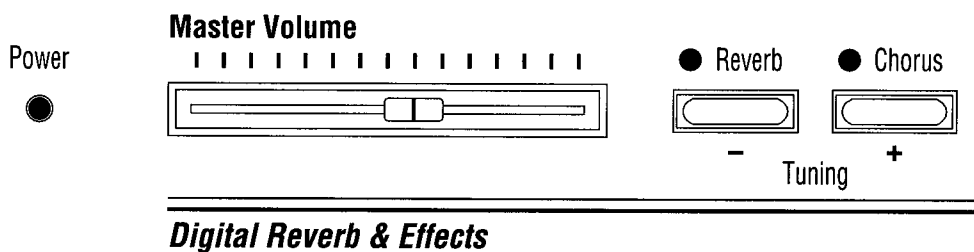

The Digital Reverb & Effects section of the panel contains controls that affect the sound of the Mark 2.

---

## Demo

---

## The Keyboard And Pedals

---

## Sound Select

---

## Digital Reverb & Effects

---

## MASTER VOLUME

The Master Volume slider controls the overall volume (loudness) of the Mark 2. Move it to the right to increase the volume, and to the left to decrease the volume; when moved all the way to the left, it silences the instrument.

Master Volume affects not only the volume produced by the internal sound system, but also the volume produced by equipment connected to the Headphone or Audio Out jacks (see page 9). **CAUTION:** Turn the Master Volume down before connecting headphones or using the Audio Out jacks.

**WARNING:** Master Volume does not affect the signal that comes in through the Audio In jacks; this signal will play at full volume! If you wish to be able to control the level of the external device connected to these inputs, the device must have a volume control of its own.

---

## REVERB AND CHORUS

For a heightened sense of sonic realism, the Mark 2 provides you with two independent types of digital effects: Reverb and Chorus. Each is controlled by its own button; press the button to turn the effect ON (LED lit) or OFF (LED unlit).

Reverb, or reverberation, occurs naturally when sound undergoes multiple reflections off the walls of an enclosed space. These reflections blend together into a “wash” of sound that adds warmth and presence to music.

Chorus gives the effect of many instruments playing together instead of just one.

When you turn the Mark 2 on, Reverb is ON, and Chorus is OFF.

---

## Recorder

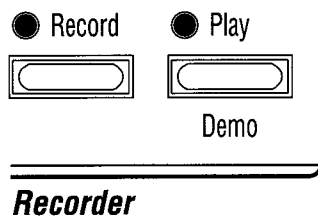

The Recorder lets you record and play back your performances on the Mark 2. Press Record; the red Record LED illuminates. The Recorder waits for you to start playing before it starts recording. It records notes, pedals, and button presses (except the Function Select button). (HINT: To record using a certain sound or effect, select the sound or effect *after* you press Record.) To stop recording, press Record again; the red LED goes out. If you reach the capacity of the Recorder (about 1,000 notes), recording stops automatically and the red LED goes out.

Press Play to play back your recording; the green Play LED illuminates and playback begins. You can play along with the recording. You can also use the pedals as well as change sounds and effects. (This will change the sound of the playback.) Playback stops automatically, and the green LED goes out, when you reach the end of the recording. If you wish to stop playback before the end, press Play again; playback stops and the green LED goes out.

Your recording remains in memory of the Mark 2 until you press Record again or until you turn the Mark 2 off.

---

## Function

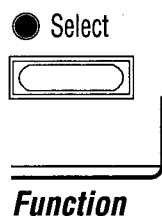

The Mark 2 has a special Function mode, from which you can do the following:

- listen to the built-in demonstration;
- tune the instrument;
- transpose the keyboard;
- adjust the velocity sensitivity of the keyboard;
- change the MIDI channel on which MIDI messages are transmitted and received;
- Local Control ON/OFF;
- Stereo/Monaural switch;
- enter Duet mode.

Some of these functions are labeled on the control panel; others are accessed from the keyboard. In Function mode, the labels *beneath* buttons indicate what those buttons accomplish.

Press the Function Select button to enter Function mode; the LED above the button illuminates.

Setting the transpose, velocity sensitivity, local control, stereo/monaural, or MIDI channel will cause the Mark 2 to exit Function mode automatically. To exit Function mode after listening to the demo or tuning the instrument, press the Function Select button again; the LED above the button goes out and the Mark 2 is returned to normal play mode.

Following is a description of the operations in Function mode.

Press the Play (Demo) button, in the Recorder section, to hear the built-in demonstration of the Mark 2; The LED will illuminate. Press the button again to stop the demo; the Play LED will go out. The Select LED will be out while playing.

---

## DEMO

---

The Mark 2 will never go out of tune. However, when playing with recordings or other musical instruments, you may desire to shift the tuning so that everything is playing at the same pitch. You can do so by as much as a quarter tone (half a half step) down or a quarter tone up.

---

## TUNING

---

Press the Reverb (-) or Chorus (+) button to shift the tuning down or up, respectively. The first button press causes the Function Select LED to flash and the tuning to reset to standard concert pitch (A 440). Each subsequent button press lowers (-) or raises (+) the pitch by one cent—a hundredth of a half step—up to a maximum of 50 cents below or 50 cents above A 440.

While you are tuning, you can play the keyboard to hear the effect of the tuning change.

To return to A 440 pitch, turn the Function Select button off (to exit Function mode), then back on (to re-enter Function mode), and press one of the Tuning buttons once.

When you turn the Mark 2 on, the tuning is always reset to A 440.

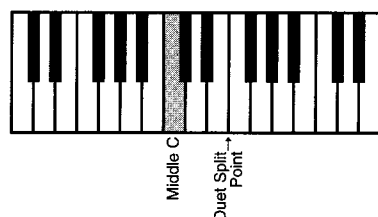

Duet mode allows two people to play on the Mark 2 at once by dividing the keyboard equally between the notes E and F above Middle C. Each side of the keyboard is individually transposed to provide both players a comfortable playing range.

---

## DUET

---

Press Function and then the Record button to access or exit Duet mode.

Note that the sound of the person playing on the right side of the keyboard will come from the right speaker only and the sound for the player on the left side of the keyboard comes from only the left speaker.

The Mark 2 will reset the keyboard to normal when the power is turned on.

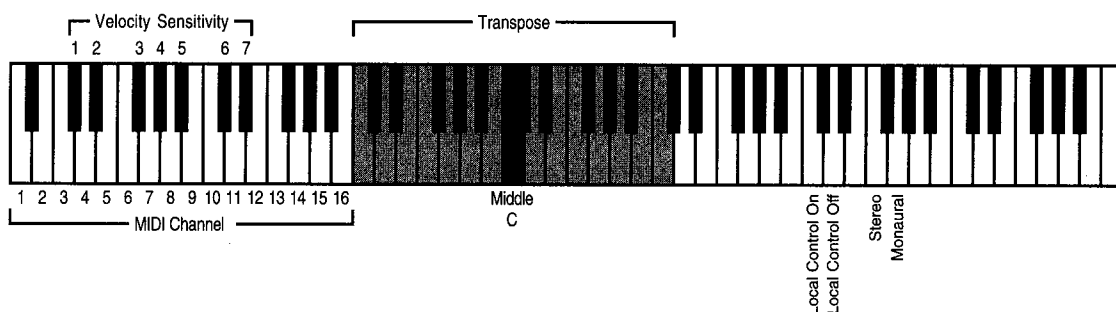

---

## KEYBOARD OPERATIONS

(see pages 8 and 9)

---

---

## TRANSPOSE

Transpose lets you play in one key and have the notes sound in another. This is useful when accompanying singers for whom the written music is too high or low, or when playing music written for a transposing instrument, such as a clarinet.

To change the transposition while in Function mode, strike a key on the keyboard within the octave above or the octave below Middle C. This keystroke (which does not sound a note) transposes the keyboard so that the Middle C key will now sound the note you selected, and the instrument will be transposed by the interval between Middle C and that note. (For example, to transpose up a fifth, strike G above Middle C.) The keystroke also causes the Mark 2 to exit Function mode. The Function Select LED goes out, and the instrument is returned to normal play mode.

When the Mark 2 is transposed, the transposition affects not only the sounds played from the keyboard, but also the note messages recorded into the Recorder or sent to another instrument or sequencer via the MIDI Out port.

NOTE: The sounds in the Mark 2 are designed to play over the full 88-note range of the keyboard. When the Mark 2 is transposed, some keys at one end of the keyboard may be silent.

To return the Mark 2 to no transposition, press the Function Select button (to re-enter Function Mode) and strike Middle C.

The Mark 2 is reset to have no transposition when power is turned on.

---

## VELOCITY SENSITIVITY

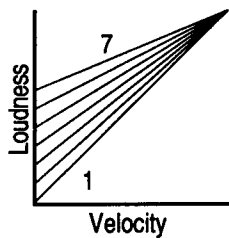

You can adjust the velocity sensitivity of the keyboard (how the dynamics of the sounds respond to key velocity) in Function mode by striking one of the seven keys that govern this setting. This keystroke (which does not sound a note), in addition to setting the velocity sensitivity of the keyboard, causes the Mark 2 to exit Function mode. The Function Select LED goes out, and the instrument is returned to normal play mode.

A setting of 1 has the greatest dynamic range, but requires high velocities to obtain loud notes; a setting of 7 has a narrower range, but makes it easier to play moderately loudly (see the graph). For example, a child beginning piano lessons may benefit from a high setting, while an experienced player may prefer a lower setting.

When power to the Mark 2 is turned on, the velocity sensitivity is set to 4.

---

## MIDI CHANNEL

While the Mark 2 is in Function mode, you can select the MIDI channel on which information is transmitted and received by striking one of the 16 keys that govern this setting. (See page 10 for more information about MIDI channels.)

The number of the key in the illustration corresponds to the number of the MIDI channel selected when that key is struck. This keystroke (which does not sound a note), in addition to setting the MIDI channel, causes the Mark 2 to exit Function mode. The Function Select LED goes out, and the instrument is returned to normal play mode.

The MIDI channel is reset to 1 every time the Mark 2 is turned on.

---

## LOCAL CONTROL

Local Control is the connection between the keyboard of the Mark 2 and the internal sound-producing circuitry of the instrument. When you turn the Mark 2 on, it automatically sets Local Control to On, so that you can play the keyboard and hear the Mark 2's sounds.

Sometimes, you need to set Local Control to Off — especially when MIDI connections bring the output of the Mark 2 back to the instrument's MIDI In port. For example, you might be using an external sequencer whose MIDI Out port works as both a MIDI Out and a MIDI Thru; this is called "soft thru." If you connect the Mark 2 to a sequencer like this and Local Control is On, playing the keyboard sends notes to both the internal circuitry and to the Mark 2's MIDI In port. The result is that every note that you play will sound "doubled." To fix this, enter Function mode and press the D6 key (2 octaves plus 1 whole step above Middle C). This sets Local Control to Off, so that the Mark 2 will only play notes that it receives at its MIDI In port.

To turn Local Control back On, enter Function mode and press the C6 key (2 octaves above Middle C). Turning the Mark 2 off and back on again also resets Local Control to On.



When you turn the Mark 2 on, the audio outputs are in Stereo; the sound is split between the Left and Right outputs for a wider, more natural sound. This works well if you connect each audio output to a separate speaker, or if you use just the internal speakers. However, if the Mark 2 is in Stereo and you connect just one audio output to an external speaker, you won't hear as full a sound. You can set the Mark 2 to Monaural, so that both outputs send out the same audio signal. To do this, enter Function mode and press the G6 key (2 octaves plus 1 fifth above Middle C). Now you can use either output, and still hear all of the sound.

To set the Mark 2 back to Stereo, enter Function mode and press the F6 key (2 octaves plus 1 fourth above Middle C). Turning the Mark 2 off and back on again also resets the Mark 2 to stereo.

This section of the manual discusses three main areas: 1) Connections to the Mark 2; 2) Service; and 3) Specifications.

A 1/4" stereo headphone jack is located underneath the keyboard on the left side, next to the power switch; providing you with a means to play or practice at the Mark 2 in privacy. Inserting a plug into the jack disables the internal speakers (although it does not disconnect the signal sent through the Audio Out jacks — see below).

The rear panel of the Mark 2 is the location of connectors for such things as the DC power adaptor, audio outputs and inputs, and MIDI.

On the DC power adaptor is a plug that fits in the Power In receptacle on the rear panel; the other end of the adaptor plugs into a standard AC wall outlet.

Two RCA jacks provide audio output to external equipment, such as a home stereo, a PA system, or a tape recorder. They consist of a Left and a Right output for a complete stereo signal. They provide line-level signals.

Two RCA jacks accept line-level audio signals from external equipment, such as a tone module, a CD player, or a tape recorder. These inputs are directed to the Left and Right channels of the internal audio system.

These inputs are inserted after the digital reverb and effects; that is, the internal effects will not be applied to the signal from an external source.

**WARNING:** The signal that comes in through these jacks will play at full volume! These inputs are not affected by the Master Volume control of the Mark 2. If you wish to be able to control the level of the external device connected to these inputs, the device must have a volume control of its own.

“MIDI” stands for “Musical Instrument Digital Interface.” It is an international specification that allows electronic musical instruments to communicate with each other, using a simple cable connection. It ensures that the Mark 2 will remain compatible with the instruments of today and tomorrow.

On the rear panel of the Mark 2 are two five-pin MIDI ports:

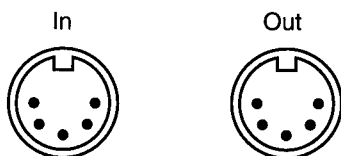

---

## STEREO/ MONAURAL

---

## Additional Information

---

## HEADPHONE JACK

---

## REAR PANEL

### Power In

### Audio Out

### Audio In

---

## MIDI

- In receives MIDI information from other equipment.
- Out sends MIDI information to other equipment.

Standard MIDI cables provide the connections between the MIDI ports of one piece of equipment and those of another.

The simplest use of MIDI is to play two instruments at a time from the keyboard of one of them. Use a MIDI cable to connect the MIDI Out port of the instrument whose keyboard you'll play (called the "master") to the MIDI In port of the other instrument (the "slave"). You probably will want to use the Mark 2 as your master keyboard.

If the slave doesn't have built-in amplification and speakers, you can connect its audio outputs to the Audio In jacks on the Mark 2.

It is important to explain that what is sent over the MIDI cable is information (data), not sound. Each connected instrument produces its own sounds; this "layering" of different sounds is one of the benefits of MIDI. For the Mark 2, the information transmitted and received falls into four categories: playing notes, operating the pedals, selecting sounds, and turning Reverb and Chorus on or off.

Another application of MIDI is in using an external *sequencer* to record and play back your performances. The sequencer can be a special hardware unit designed for that purpose, or it can be a personal computer running special sequencing software. In either case, the MIDI connections are the same—Out to In and In to Out.

A MIDI sequencer can control several instruments, each playing a different part, at the same time. To do this, it relies on MIDI *channels*. MIDI channels are like TV channels: an instrument has to be "tuned" to the correct one or it won't receive what is being transmitted. There are 16 channels available, numbered 1–16; the Mark 2 can be set to any one of them. (Information on setting the MIDI channel of the Mark 2 can be found on page 8.) The channel is set to 1 when the Mark 2 is turned on.

Page 24 shows the complete MIDI Implementation Chart for the Mark 2.

---

## SERVICE

The Mark 2 contains no user-serviceable parts. In the event that you should experience a problem with the operation of the instrument, see your local Young Chang/Kurzweil dealer.

---

## SPECIFICATIONS

Following are physical, audio, and power supply specifications for the Mark 2.

### Physical

- Height: 32.9" (83.5 cm)
- Depth: 19.3" (49.0 cm)
- Length: 54.3" (138.0 cm)
- Weight:
 

|       |                       |
|-------|-----------------------|
| Body  | 82.0 lbs. (37.3 kg)   |
| Stand | 31.25 lbs. (14.2 kg)  |
| TOTAL | 113.25 lbs. (51.5 kg) |

### Audio

- 20-Watt Amplification: 2 x 10 Watts
- 4 Speakers: 2 x 5.25" (130 mm) woofer/midrange  
2 x 2" (50 mm) cone tweeter

### Power Supply

- AC Adaptor: 13.5 Volts DC, 1.7 Amps
- Power Consumption: 1 Amps nominal
- Model Number: PD135-17

**WARNING:** Be sure the DC power adaptor is labeled "PD135-17." Use of any other power adaptor may damage your instrument or result in seriously degraded performance.

# MIDI Implementation Chart

## Model: Kurzweil Mark 2

Manufacturer:

Young Chang

Date: Feb. 98

Digital Piano

Version: 1.0

| Function                | Transmitted  | Recognized       | Remarks                                       |
|-------------------------|--|------------------|---|
| <b>Basic Channel</b>    | Default<br>O<br>Changed<br>O   | 1<br>1-16        |   |
| <b>Mode</b>             | Default<br>X<br>Messages<br>X<br>Altered<br>X  | X<br>X<br>X      | always in mode 3                              |
| <b>Note Number</b>      | 0-127<br>12-108<br>True Voice  | 0-127<br>12-108  | key range:<br>C0-C8                           |
| <b>Velocity</b>         | Note ON<br>O<br>Note OFF<br>O  | O<br>O           |   |
| <b>After Touch</b>      | Keys<br>X<br>Channel<br>X  | X<br>X           |   |
| <b>Pitch Bender</b>     | X  | X                |   |
| <b>Control Change</b>   | 64<br>O<br>67<br>O<br>83<br>O  | O<br>O<br>O*     | sustain pedal<br>soft pedal<br>Reverb select* |
| <b>Program Change</b>   | O<br>0-3<br>True #   | O<br>0-3         | 0-3   |
| <b>System Exclusive</b> | X  | X                |   |
| <b>System Real Time</b> | Song Pos<br>X<br>Song Sel<br>X<br>Tune<br>X  | X<br>X<br>X      |   |
| <b>System Real Time</b> | Clock<br>X<br>Messages<br>X  | X<br>X           |   |
| <b>Aux Messages</b>     | Local Control<br>X<br>All Notes Off<br>X<br>Active Sense<br>X<br>Reset<br>X                                  | O<br>X<br>X<br>X |   |
| <b>Notes</b>            | *Reverb Select: 0-31 = No Reverb<br>32-63 = Reverb Only<br>64-95 = Chorus Only<br>96-127 = Reverb and Chorus |                  |   |

Mode 1: OMNI ON, POLY  
Mode 3: OMNI OFF, POLY

Mode 2: OMNI ON, MONO  
Mode 4: OMNI OFF, MONO

O = yes  
X = no