

# ***Forte***<sup>TM</sup> STAGE PIANO

## Musician's Guide



FLASHPLAY<sup>TM</sup>

**KURZWEIL**<sup>®</sup>

It's the sound.<sup>®</sup>

Part Number 910557-002 Rev.B

Written for software release v1.21 and OS 3.21.23952

# ***For*te™**

FLASH  PLAY™

# **KURZWEIL®**

It's the **sound.**®

©2014 Young Chang Co., Ltd. All rights reserved. Kurzweil® is a product line of Young Chang Co., Ltd. Kurzweil®, Young Chang®, V. A. S. T.®, Forte™, and FlashPlay™ are trademarks of Young Chang Co., Ltd. All other trademarks and copyrights are property of their respective companies. Product features and specifications are subject to change without notice.

U.S. Patents 6,806,413, 6,978,288, 8,263,849

You may legally print up to two (2) copies of this document for personal use. Commercial use of any copies of this document is prohibited. Young Chang Co. retains ownership of all intellectual property represented by this document.

**Part Number 910557-002 Rev. B**

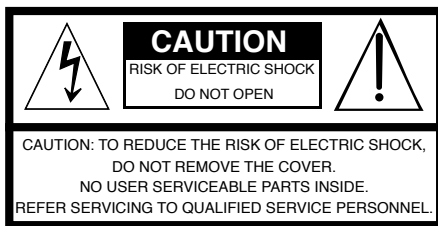

The lightning flash with the arrowhead symbol, within an equilateral triangle is intended to alert the user to the presence of uninsulated "dangerous voltage" within the product's enclosure that may be of sufficient magnitude to constitute a risk of electric shock to persons.



The exclamation point within an equilateral triangle is intended to alert the user to the presence of important operating and maintenance (servicing) instructions in the literature accompanying the product.

## IMPORTANT SAFETY & INSTALLATION INSTRUCTIONS

### INSTRUCTIONS PERTAINING TO THE RISK OF FIRE ELECTRIC SHOCK , OR INJURY TO PERSONS

**WARNING:** When using electric products, basic precautions should always be followed, including the following:

1. Read all the Safety and Installation Instructions and Explanation of Graphic Symbols before using the product.
2. This product must be grounded. If it should malfunction or break down, grounding provides a path of least resistance for electric current to reduce the risk of electric shock. This product is equipped with a power supply cord having an equipment-grounding conductor and a grounding plug. The plug must be plugged into an appropriate outlet which is properly installed and grounded in accordance with all local codes and ordinances.  
**DANGER:** Improper connection of the equipment-grounding conductor can result in a risk of electric shock. Do not modify the plug provided with the product – if it will not fit the outlet, have a proper outlet installed by a qualified electrician. Do not use an adaptor which defeats the function of the equipment-grounding conductor. If you are in doubt as to whether the product is properly grounded, check with a qualified serviceman or electrician.
3. Do not use this product near water – for example, near a bathtub, washbowl, kitchen sink, in a wet basement, or near a swimming pool, or the like.
4. This product should only be used with a stand or cart that is recommended by the manufacturer.
5. This product, either alone or in combination with an amplifier and speakers or headphones, may be capable of producing sound levels that could cause permanent hearing loss. Do not operate for a long period of time at a high volume level or a level that is uncomfortable. If you experience any hearing loss or ringing in the ears, you should consult an audiologist.
6. This product should be located so that its location or position does not interfere with its proper ventilation.
7. The product should be located away from heat sources such as radiators, heat registers, or other products that produce heat.

8. The product should be connected to a power supply only of the type described in the operating instructions or as marked on the product.
9. This product may be equipped with a polarized line plug (one blade wider than the other). This is a safety feature. If you are unable to insert the plug into the outlet, contact an electrician to replace your obsolete outlet. Do not defeat the safety purpose of the plug.
10. The power supply cord of the product should be unplugged from the outlet when left unused for a long period of time. When unplugging the power supply cord, do not pull on the cord, but grasp it by the plug.
11. Care should be taken so that objects do not fall and liquids are not spilled into the enclosure through openings.
12. The product should be serviced by qualified service personnel when:
  - A. The power supply cord or the plug has been damaged;
  - B. Objects have fallen, or liquid has been spilled into the product;
  - C. The product has been exposed to rain;
  - D. The product does not appear to be operating normally or exhibits a marked change in performance;
  - E. The product has been dropped, or the enclosure damaged.
13. Do not attempt to service the product beyond that described in the user maintenance instructions. All other servicing should be referred to qualified service personnel.
14. **WARNING:** Do not place objects on the product's power supply cord, or place the product in a position where anyone could trip over, walk on, or roll anything over cords of any type. Do not allow the product to rest on or be installed over cords of any type. Improper installations of this type create the possibility of a fire hazard and/or personal injury.

## RADIO AND TELEVISION INTERFERENCE

**WARNING:** Changes or modifications to the instrument not expressly approved by Young Chang could void your authority to operate the instrument.

**IMPORTANT:** When connecting this product to accessories and/or other equipment use only high quality shielded cables.

**NOTE:** This instrument has been tested and found to comply with the limits for a Class B digital device, pursuant to Part 15 of the FCC Rules. These limits are designed to provide reasonable protection against harmful interference in a residential installation. This instrument generates, uses, and can radiate radio frequency energy and, if not installed and used in accordance with the instructions, may cause harmful interference to radio communications. However, there is no guarantee that interference will not occur in a particular installation. If this instrument does cause harmful interference to radio or television reception, which can be determined by turning the instrument off and on, the user is encouraged to try to correct the interference by one or more of the following measures:

- Reorient or relocate the receiving antenna.

- Increase the separation between the instrument and the receiver.
- Connect the instrument into an outlet on a circuit other than the one to which the receiver is connected.
- If necessary consult your dealer or an experienced radio/television technician for additional suggestions.

The normal function of the product may be disturbed by strong electromagnetic interference. If so, simply reset the product to resume normal operation by following the instructions in the manual. If normal function does not resume, please use the product in another location.

### NOTICE

This apparatus does not exceed the Class B limits for radio noise emissions from digital apparatus set out in the Radio Interference Regulations of the Canadian Department of Communications.

### AVIS

Le présent appareil numérique n'émet pas de bruits radioélectriques dépassant les limites applicables aux appareils numériques de la class B prescrites dans le Règlement sur le brouillage radioélectrique édicté par le ministère des Communications du Canada.

## SAVE THESE INSTRUCTIONS

## IMPORTANT SAFETY INSTRUCTIONS

- 1) Read these instructions.
- 2) Keep these instructions.
- 3) Heed all warnings.
- 4) Follow all instructions.
- 5) Do not use this apparatus near water.
- 6) Clean only with dry cloth.
- 7) Do not block any of the ventilation openings. Install in accordance with the manufacturer's instructions.
- 8) Do not install near any heat sources such as radiators, heat registers, stoves, or other apparatus (including amplifiers) that produce heat.
- 9) Do not defeat the safety purpose of the polarized or grounding-type plug. A polarized plug has two blades with one wider than the other. A grounding type plug has two blades and a third grounding prong. The wide blade or the third prong are provided for your safety. If the provided plug does not fit into your outlet, consult an electrician for replacement of the obsolete outlet
- 10) Protect the power cord from being walked on or pinched, particularly at plugs, convenience receptacles, and the point where they exit from the apparatus.



- 11) Only use attachments/accessories specified by the manufacturer.
- 12) Use only with a cart, stand, tripod, bracket, or table specified by the manufacturer, or sold with the apparatus. When a cart is used, use caution when moving the cart/apparatus combination to avoid injury from tip-over.
- 13) Unplug this apparatus during lightning storms or when unused for long periods of time.
- 14) Refer all servicing to qualified service personnel. Servicing is required when the apparatus has been damaged in any way, such as power-supply cord or plug is damaged, liquid has been spilled or objects have fallen into the apparatus, the apparatus has been exposed to rain or moisture, does not operate normally, or has been dropped.

**Warning:** To reduce the risk of fire or electric shock, do not expose this apparatus to rain or moisture. Do not expose this equipment to dripping or splashing and ensure that no objects filled with liquids, such as vases, are placed on the equipment.

To completely disconnect this equipment from the AC Mains, disconnect the power supply cord plug from the AC receptacle.

This product contains chemicals known to the State of California to cause cancer or birth defects or other reproductive harm. Wash hands after handling. Remarks: As with most electronic equipment, the outer cables may contain phthalate and the copper alloy power plug contains lead.

# Kurzweil International Contacts

Contact the Kurzweil office listed below to locate your local Kurzweil representative.

## US Customers:

American Music & Sound  
925 Broadbeck Dr #220  
Newbury Park, CA 91320

Tel: 800-431-2609

Fax: 818-597-0411

Email: [info@americanmusicandsound.com](mailto:info@americanmusicandsound.com)

## Customers outside the US:

Young Chang Co., LTD.  
9th Floor, Bldg 102, I-Park,  
Jeongja-Dong, Bundang-Gu, Seongnam-Si,  
Gyeonggi-Do  
463-859 South Korea

Tel: +82 31 786 7900



[www.kurzweil.com](http://www.kurzweil.com)



[support@kurzweil.com](mailto:support@kurzweil.com)



[www.facebook.com/kurzweilmusicsystems/](http://www.facebook.com/kurzweilmusicsystems/)



[www.twitter.com/KurzweilMusic](http://www.twitter.com/KurzweilMusic)



[www.youtube.com/user/KurzweilTutorials](http://www.youtube.com/user/KurzweilTutorials)

# Contents

Kurzweil International Contacts.....	iv
<b>Introducing the Forte .....</b>	<b>1-1</b>
<b>Main Features .....</b>	<b>1-1</b>
Sounds.....	1-2
Keyboard and Controllers .....	1-2
Pedals (Optional) .....	1-3
<b>Keeping the Forte up to date.....</b>	<b>1-3</b>
<b>Do You Have Everything? .....</b>	<b>1-3</b>
<b>Music Rack (Optional).....</b>	<b>1-4</b>
<b>Getting Started .....</b>	<b>2-1</b>
<b>Before You Start.....</b>	<b>2-1</b>
<b>Setting up the Forte.....</b>	<b>2-1</b>
<b>Using the Forte .....</b>	<b>2-3</b>
<b>The Rear Panel.....</b>	<b>2-4</b>
The AC Power Jack.....	2-4
The USB Ports .....	2-4
The MIDI Ports (IN / THRU / OUT) .....	2-4
Basic MIDI Hookup .....	2-5
Connecting More Sound Modules .....	2-5
The Pedal Jacks.....	2-7
The SW1 (Sustain), SW2 and SW3 Jacks.....	2-7
Connecting a Half Damper Pedal .....	2-8
Connecting a Dual Switch Pedal .....	2-9
The CC1 (Volume) and CC2 Jacks.....	2-9
The Audio Jacks (A & B Audio Outputs).....	2-10
The Headphones Jack .....	2-10
<b>Connecting to Your Audio System.....</b>	<b>2-11</b>
<b>Connecting to a Computer .....</b>	<b>2-13</b>
<b>Selecting Programs and Multis .....</b>	<b>2-14</b>
Selecting Programs.....	2-14
Selecting Multis .....	2-15
User Programs and Multis.....	2-15
Controller Info.....	2-15

Favorites .....	2-15
<b>Modes .....</b>	<b>2-16</b>
Program Mode .....	2-16
Controller Conventions .....	2-16
Saving Programs .....	2-16
Splits and Layers .....	2-17
Program Edit Mode .....	2-17
Multi Mode.....	2-17
Multi Edit Mode .....	2-17
Global Mode.....	2-17
MIDI Settings .....	2-17
Info.....	2-17
System Reset .....	2-18
Storage Mode.....	2-18
Saving to External Storage .....	2-18
Loading from External Storage .....	2-18
<b>Updating the Forte.....</b>	<b>2-18</b>
<b>Features of the Forte .....</b>	<b>3-1</b>
<b>Powering Up Defaults .....</b>	<b>3-1</b>
Parameters Reset To Defaults At Power-On.....	3-1
Parameters Remembered After Power-On .....	3-1
<b>The Front Panel .....</b>	<b>3-2</b>
<b>Pitch and Modulation Wheels.....</b>	<b>3-3</b>
Pitch Wheel.....	3-3
Modulation Wheel .....	3-3
<b>Real Time Control.....</b>	<b>3-4</b>
Sliders .....	3-4
LED Ladders.....	3-5
Zone Mute/Volume Buttons.....	3-5
Switches.....	3-5
Foot Switches and Controllers .....	3-6
KB3 Buttons .....	3-6
<b>Transpose Buttons .....</b>	<b>3-6</b>
<b>Variation Button.....</b>	<b>3-7</b>
<b>Tap Tempo Button .....</b>	<b>3-7</b>
<b>Save Button.....</b>	<b>3-7</b>
<b>Master EQ &amp; Compressor .....</b>	<b>3-8</b>
Master EQ.....	3-8
Compressor.....	3-8

---

<b>Audio In</b> .....	<b>3-10</b>
<b>Mode Buttons</b> .....	<b>3-11</b>
Program Button .....	3-11
Multi Button .....	3-11
Global Button .....	3-11
<b>Navigation</b> .....	<b>3-12</b>
The Color LCD Display .....	3-12
Previous (–) and Next (+) Value Buttons.....	3-13
Channel / Zone Buttons .....	3-13
Alpha Wheel.....	3-13
Display Brightness Knob.....	3-14
<b>KB3 LED</b> .....	<b>3-14</b>
<b>Category &amp; Keypad</b> .....	<b>3-15</b>
Category.....	3-15
Keypad.....	3-15
<b>Double Button Presses</b> .....	<b>3-16</b>
Value Jump .....	3-16
Channel / Zone Jump.....	3-16
Reset Transposition .....	3-17
Program Demo.....	3-17
Song Demo .....	3-18
Panic .....	3-18
<b>Terminology</b> .....	<b>4-1</b>
<b>The Operating Modes</b> .....	<b>5-1</b>
<b>Program Mode</b> .....	<b>5-1</b>
<b>Multi Mode</b> .....	<b>5-2</b>
<b>Global Mode</b> .....	<b>5-3</b>
<b>Storage Mode</b> .....	<b>5-4</b>
<b>Functions</b> .....	<b>5-5</b>
The Split Function .....	5-5
The Layer Function .....	5-5
Song Demo Function .....	5-6
Program Demo Function.....	5-7
<b>Program Edit Mode</b> .....	<b>5-8</b>
<b>Multi Edit Mode</b> .....	<b>5-8</b>
<b>Program Mode</b> .....	<b>6-1</b>
<b>About Program Mode</b> .....	<b>6-1</b>

<b>Selecting Programs</b> .....	<b>6-2</b>
Program Demo.....	6-3
The Color Display.....	6-4
Pop-Up Messages.....	6-5
MIDI In/Out Activity Indicators.....	6-5
Alpha Wheel & Previous (–) and Next (+) Value Buttons.....	6-5
Value Jump Buttons.....	6-6
Category Buttons.....	6-6
Keypad button.....	6-7
Choosing Category Default Programs.....	6-8
Choosing Favorites.....	6-9
Favorites View and Favorites Banks.....	6-9
<b>Transposition</b> .....	<b>6-10</b>
<b>Parameter Assignments</b> .....	<b>6-11</b>
Controller Conventions.....	6-12
<b>The Split Function</b> .....	<b>6-13</b>
Program.....	6-14
Volume.....	6-14
Key Range.....	6-14
Pan.....	6-15
Saving a Split.....	6-15
<b>The Layer Function</b> .....	<b>6-16</b>
Program.....	6-17
Volume.....	6-17
Key Range.....	6-17
Pan.....	6-18
Saving a Layer.....	6-18
<b>Changing the MIDI Transmit Channel</b> .....	<b>6-19</b>
<b>Panic</b> .....	<b>6-20</b>
<b>Save User Programs</b> .....	<b>6-21</b>
Changing ID Numbers.....	6-21
Naming a User Program.....	6-23
Saving a User Program.....	6-24
<b>Program Edit Mode</b> .....	<b>7-1</b>
<b>About Program Edit Mode</b> .....	<b>7-1</b>
<b>Selecting Parameters</b> .....	<b>7-2</b>
The Display.....	7-2
Alpha Wheel & Previous (–) and Next (+) Value Buttons.....	7-2
Assign.....	7-3
Enter + Controller.....	7-3

<b>Program Pages .....</b>	<b>7-4</b>
PARAMS Page .....	7-4
Parameter .....	7-5
Important note about selecting a Control source .....	7-6
Value .....	7-6
Important note about values of “None” .....	7-6
FX Page .....	7-7
Insert .....	7-8
Aux 1, Aux 2 .....	7-8
Output .....	7-9
Auxiliary Send Parameters .....	7-9
COMMON Page .....	7-10
BendRange Up & BendRange Down .....	7-10
Output Gain .....	7-11
Category .....	7-11
Monophonic .....	7-11
Legato .....	7-11
Portamento .....	7-11
Portamento Rate .....	7-12
Mono Sample XFade .....	7-12
 <b>Multi Mode .....</b>	 <b>8-1</b>
<b>About Multi Mode .....</b>	<b>8-1</b>
<b>Selecting Multis .....</b>	<b>8-2</b>
The Color Display .....	8-2
Pop-Up Messages .....	8-3
MIDI In/Out Activity Indicators .....	8-3
Alpha Wheel & Previous (–) and Next (+) Value Buttons .....	8-3
Value Jump Buttons .....	8-3
The Cursor Buttons .....	8-3
Category Buttons .....	8-4
Choosing Favorites .....	8-5
Favorites View and Favorites Banks .....	8-5
<b>About Zones .....</b>	<b>8-6</b>
Muting Zones .....	8-6
<b>Transposition .....</b>	<b>8-7</b>
<b>Parameter Assignments .....</b>	<b>8-8</b>
Controller Conventions .....	8-8
<b>The Split Function .....</b>	<b>8-9</b>
Program .....	8-10
Volume .....	8-10
Key Range .....	8-10

Pan .....	8-10
Saving a Split .....	8-11
<b>The Layer Function .....</b>	<b>8-12</b>
Program .....	8-13
Volume .....	8-13
Key Range .....	8-13
Pan .....	8-13
Saving a Layer .....	8-14
<b>Save User Multis .....</b>	<b>8-15</b>
Changing ID Numbers .....	8-16
Naming a User Multi .....	8-17
Saving a User Multi .....	8-18
<b>Multi Edit Mode .....</b>	<b>9-1</b>
<b>About Multi Edit Mode .....</b>	<b>9-1</b>
<b>Selecting Parameters .....</b>	<b>9-3</b>
The Display .....	9-3
Changing Zones .....	9-3
Alpha Wheel & Previous (-) and Next (+) Value Buttons .....	9-4
Assign .....	9-4
Enter + Controller .....	9-5
<b>Zone Parameters .....</b>	<b>9-5</b>
<b>OVERVIEW Page .....</b>	<b>9-6</b>
Status .....	9-6
Program .....	9-6
Key Range .....	9-7
Volume .....	9-7
<b>MAIN Page .....</b>	<b>9-8</b>
Transpose .....	9-9
Note Map .....	9-9
Destination .....	9-9
Out .....	9-11
Channel .....	9-11
BankMode .....	9-11
MidiBank .....	9-12
MidiProg .....	9-12
EntryPrgChg .....	9-13
Bend Up / Down ST & Bend Up / Down CT .....	9-13
VelMode .....	9-13
VelScale .....	9-13
VelOffset .....	9-13
VelCurve .....	9-14

---

LoVel, HiVel .....	9-15
<b>CONTROLS Page.....</b>	<b>9-16</b>
Switch Controllers .....	9-16
Controller .....	9-17
Mode.....	9-17
Type.....	9-18
On Value .....	9-18
Off Value .....	9-18
Entry State.....	9-18
Exit State .....	9-19
Velocity .....	9-19
Key1.....Key8 .....	9-19
Key.....	9-19
Do .....	9-20
Destination.....	9-20
Continuous Controllers.....	9-20
Controller .....	9-21
Mode.....	9-22
Scale.....	9-22
Add .....	9-22
Curve .....	9-22
Entry Position.....	9-23
Exit Value.....	9-23
Destination.....	9-24
Controlling Program Parameter Assignments from Multi Mode	9-24
<b>FX Page .....</b>	<b>9-27</b>
Enable.....	9-27
Aux FX Channel.....	9-28
AUX1, AUX2 .....	9-28
AUX1 Override, AUX2 Override.....	9-28
Chain .....	9-28
<b>COMMON Page .....</b>	<b>9-29</b>
Tempo .....	9-29
Clock Source .....	9-29
KB3 Channel.....	9-30
<b>About Auxiliary Effects .....</b>	<b>9-30</b>
<b>Save and Delete User Multis.....</b>	<b>9-30</b>
<b>Global Mode.....</b>	<b>10-1</b>
<b>About Global Mode.....</b>	<b>10-1</b>
<b>Selecting and Editing Parameters .....</b>	<b>10-2</b>
<b>MAIN1 Page.....</b>	<b>10-3</b>

---

Tune .....	10-3
Transpose .....	10-3
FX Mode.....	10-4
Display .....	10-4
Show Controllers.....	10-4
Auto Power Off .....	10-4
Power Off Time .....	10-5
Audio Input.....	10-5
Clock Source.....	10-5
Out Pair B Mode.....	10-5
Audio Out S/M.....	10-5
Multi Controllers .....	10-6
<b>MAIN2 Page.....</b>	<b>10-7</b>
Velocity Map.....	10-8
Pressure Map.....	10-8
Intonation Map .....	10-9
Int. Key (Intonation Key).....	10-10
Drum Remap.....	10-10
Pedal Noise.....	10-10
User Type.....	10-10
Switch Pedal Overrides.....	10-11
CC Pedal Overrides .....	10-12
Rotary Override.....	10-12
<b>MIDI Page .....</b>	<b>10-12</b>
Destination .....	10-13
Change Multis .....	10-14
Bank Select.....	10-14
PrgChangeMode.....	10-15
LocalKbdChan (Local Keyboard Channel).....	10-15
Program Mode .....	10-15
Multi Mode .....	10-16
Sysex ID .....	10-16
<b>TOOLS Page.....</b>	<b>10-17</b>
MIDI.....	10-17
VOICES.....	10-18
STATE .....	10-19
INFO.....	10-19
ABOUT.....	10-20
<b>DELETE Page.....</b>	<b>10-20</b>
<b>RESET Page.....</b>	<b>10-21</b>
Reset Forte To Its Factory State .....	10-21
<b>Storage Mode .....</b>	<b>11-1</b>

---

<b>About Storage Mode .....</b>	<b>11-1</b>
<b>Storage Mode Common Features .....</b>	<b>11-2</b>
Directories .....	11-2
Path .....	11-2
Common Dialogues .....	11-3
The Select Directory Dialogue .....	11-3
The File Name / New Directory Dialogue .....	11-4
<b>The STORE page .....</b>	<b>11-5</b>
Pressing STORE .....	11-6
<b>The LOAD page .....</b>	<b>11-7</b>
Pressing LOAD .....	11-8
Example using LOAD .....	11-9
Compatible Files .....	11-10
<b>System Mode .....</b>	<b>12-1</b>
Run Forte .....	12-2
System Update .....	12-3
Install using a USB flash drive .....	12-4
Install using a computer/tablet .....	12-7
Run Diagnostics .....	12-10
System Reset .....	12-11
System Utilities .....	12-13
Format Flash .....	12-14
Install Module .....	12-16
Restore Older .....	12-16
Display Diag .....	12-16
<b>Troubleshooting .....</b>	<b>13-1</b>
Maintenance .....	13-1
Common Problems .....	13-1
Power Problems .....	13-1
Display “Brightness” .....	13-2
Audio Problems .....	13-2
MIDI Problems .....	13-5
Pedal Problems .....	13-6
Switch Pedal Problems .....	13-6
If None of the Above .....	13-7
Restoring Factory Defaults .....	13-7
Diagnostics .....	13-7
<b>MIDI Implementation .....</b>	<b>A-1</b>

---

**Physical Specifications ..... B-1**

**Programs ..... C-1**

**KB3 Programs ..... D-1**

**Introducing KB3 Programs..... D-1**

        First Some History..... D-1

        KB3 Improvements in the Forte ..... D-1

**Drawbars ..... D-2**

**KB3 Mode Buttons ..... D-2**

        Brake..... D-2

        Chorus/Vibrato ..... D-2

            On/Off ..... D-2

            Chor/Vib..... D-2

            Chorus/Vibrato Depth ..... D-3

        Percussion ..... D-3

            Percussion On/Off ..... D-3

            Percussion Loud/Soft..... D-3

            Percussion Decay F/S ..... D-3

            Percussion Pitch H/L ..... D-3

        KeyClick ..... D-3

        Variation ..... D-4

**Multis..... E-1**

**Effects ..... F-1**

**Index..... I-1**

# Chapter 1

## Introducing the Forte

Congratulations on your purchase of the Kurzweil Forte® Stage Piano!

This manual will help you get acquainted with your new instrument. Be sure to keep the manual on hand as you continue to familiarize yourself with the features and functions of the Forte.



## Main Features

The Forte Stage Piano is the most advanced keyboard to ever bear the Kurzweil logo. Featuring Flash-Play technology and a high resolution color display, the Forte boasts hundreds of excellent preset sounds, with a massive 16GB of ROM and 128 voice polyphony. The Forte's new sounds are modeled after Steinway Hamburg D and Vintage Yamaha C7 pianos, Rhodes ('73 and '77) and Wurlitzer electric pianos, Clavinet D6 (rhythm and treble pickups) and French Harpsichord (five dispositions).

The Forte's new piano sounds offer a full range of dynamics, from the most delicate pianissimo to the full-on thunder of the heaviest fortissimo. These piano sounds utilize long unlooped samples allowing for beautiful harmonic interplay between sustained notes.

Mechanical key release and pedal samples provide added realism. The Forte's Piano programs can also be played with "Half Damper" sustain pedal techniques (this requires a continuous switch pedal, see "Connecting a Half Damper Pedal" on page 2-8 for details).

## Introducing the Forte

---

Also included are rich new orchestral percussion instruments such as Celeste, Bells, Glockenspiel, Chimes, and Crotales (hit and bowed).

Forte also includes our fully featured Kurzweil KB3 ToneReal™ organ simulator designed to emulate classic tone wheel organs like the Hammond B3, as well as Farfisa and Vox organs.

The Forte is also a very capable MIDI controller ideally suited to controlling additional sound modules and as input to a sequencer.

## Sounds

- New German & Japanese Grand Pianos
- Rhodes ('73 and '77) and Wurlitzer electric pianos, Clavinet D6 (rhythm and treble pickups) and French Harpsichord (five dispositions)
- New Orchestral Percussion: Celeste, Bells, Glockenspiel, Chimes, and Crotales (hit and bowed)
- Selected sounds from our acclaimed PC3/Artis series & Kore64 expansion
- 16GB ROM used with our highly acclaimed FX Engine.
- KB3 ToneReal™ organ simulations with 9 sliders as drawbars (Hammond™ simulation uses 0 voices of polyphony)
- More than 300 Factory Programs divided into 20 Categories
- 1024 User IDs to save your own Programs
- More than 150 Factory Multis
- 1024 User IDs to save your own Multis
- MP3 player audio input jack
- Full 128 voices of polyphony

## Keyboard and Controllers

The Forte has an 88-key fully-weighted hammer action keyboard that provides you with a piano-like feel without adding excessive weight to the instrument. The array of physical controllers includes:

- 9 assignable sliders (with LED ladders)
- 9 switches (assignable/zone mutes/KB3 control)
- A pitch wheel
- A modulation wheel
- 1 Variation switch
- 1 Tap Tempo switch
- 2 Transpose switches

- Monopressure (Aftertouch)
- 3 jacks on the rear panel for switch pedals: SW1 (Sustain), SW2 & SW3
- 2 jacks on the rear panel for optional continuous controller pedals: CC1 (Volume) & CC2

## Pedals (Optional)

As described above, the Forte has five jacks on the rear panel for optional pedal controllers.

Three jacks for switch pedals, which are typically used to control two-state (i.e., on / off) parameters such as sustain, sostenuto, and soft. A Half Damper pedal (also known as a continuous switch pedal) can be used to allow for “half pedaling” sustain techniques when playing Forte piano programs.

The remaining two jacks are for continuous control (or CC) pedals typically used to control multi-state (i.e., “continuous”) parameters such as volume and wah.

Your Kurzweil dealer stocks the following pedals:

- FS-1 Standard single box-shaped switch pedal
- KFP-1 Single piano-style switch pedal
- KFP-2S Double piano-style switch pedal unit (one stereo plug)
- CC-1 Continuous pedal

## Keeping the Forte up to date

Be sure to check the Kurzweil Music Systems website at <http://www.kurzweil.com> for new documentation and the latest software updates for Forte. This manual was written for Forte software release v1.21 and OS 3.21.23952. See the Info page in Global mode to check the currently installed OS version.

## Do You Have Everything?

Your Forte package should contain the following in addition to your instrument:

- Power cable
- Switch pedal
- USB cable (Type-A-to-Type-B)
- 4 self adhesive feet (see page 2-1)
- Forte Getting Started manual

If you don't have any of these components, please contact your Kurzweil / Young Chang dealer to get them.

## Music Rack (Optional)

The optional KMR2 Music Rack attachment is a holder for sheet music or a computer tablet device. Contact your Kurzweil dealer for the KMR2 Music Rack. Please refer to the instructions that come with the KMR2 on attaching the music rack to the Forte.

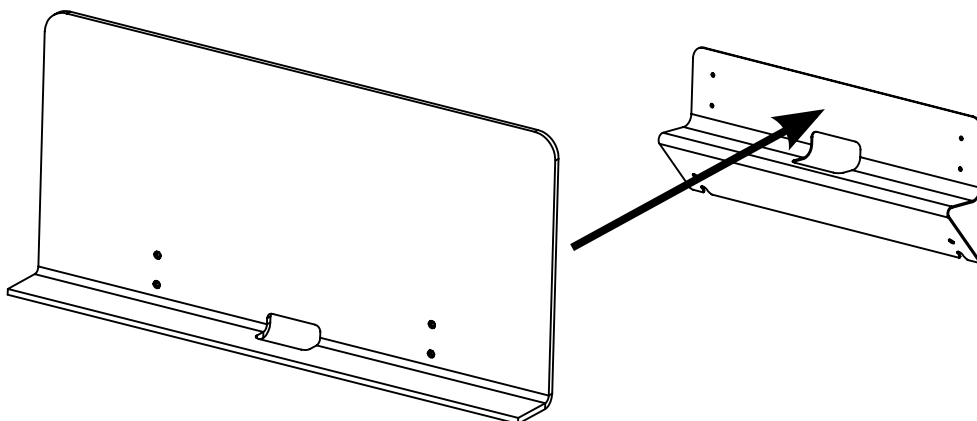

# Chapter 2

## Getting Started

As the excited owner of a brand-new keyboard, you've probably already unpacked your Forte and want to check it out. This chapter will help you to hook the Forte up to both your audio and MIDI systems, give you a quick overview of how it works, and show you how to start making great sounds with your new Forte.

### Before You Start...

Don't connect anything until you make sure the Forte is properly and safely situated. If your Forte keyboard has been out in the cold, give it time to warm up to room temperature before starting it, since condensation may have formed inside.

### Setting up the Forte

1. Set the keyboard on a hard, flat, level surface.
2. Four adhesive-backed rubber feet are provided with your Forte. Carefully turn the keyboard over onto a soft surface, remove the paper backing from the rubber feet and attach them.

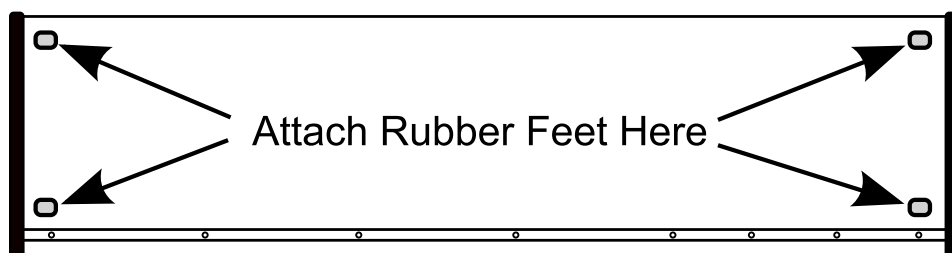

**NOTE :** Unless the instrument will always be used with a keyboard stand, attachment of the rubber feet is strongly advised. Otherwise protruding screws may scratch the tabletop.

## Getting Started

---

3. Connect the AC power cord to the Forte. Before plugging the cable into a power outlet, check that your power source is compatible with the Forte. The Forte runs on AC power and works with voltages from 100-240 volts at 50–60 Hz. The voltage level is detected and set automatically by the Forte. If your power source does not have the standard three hole outlet, you should take the time to install a proper grounding system. This will reduce the risk of a shock. If your power outlet is not within these ranges it is recommended you use an appropriate adaptor.
4. Plug the power cable into the wall.
5. Plug the Switch Pedal into the marked SW1 (Sustain) Pedal jack on the Forte rear panel.
6. Connect stereo headphones to the headphone jack on the front left panel, or connect the audio outputs to your mixer or amplifier inputs using standard (1/4-inch) audio cables (use the Left out for mono). Balanced (“TRS” or “Stereo”) cables are recommended if your mixer or amp supports balanced inputs.
7. Make sure your sound system is at a safe volume level. Also make sure that the Forte Master Volume slider (on the far left side of the front panel) is all the way down.

## Using the Forte

1. Power up the Forte using the power switch on the rear left side of the instrument, and then raise the Master Volume slider, and mixer/amp volume. Your Forte keyboard starts up in Program Mode by default. Press one of the buttons under the “Mode” label to the right of the display to switch Modes.

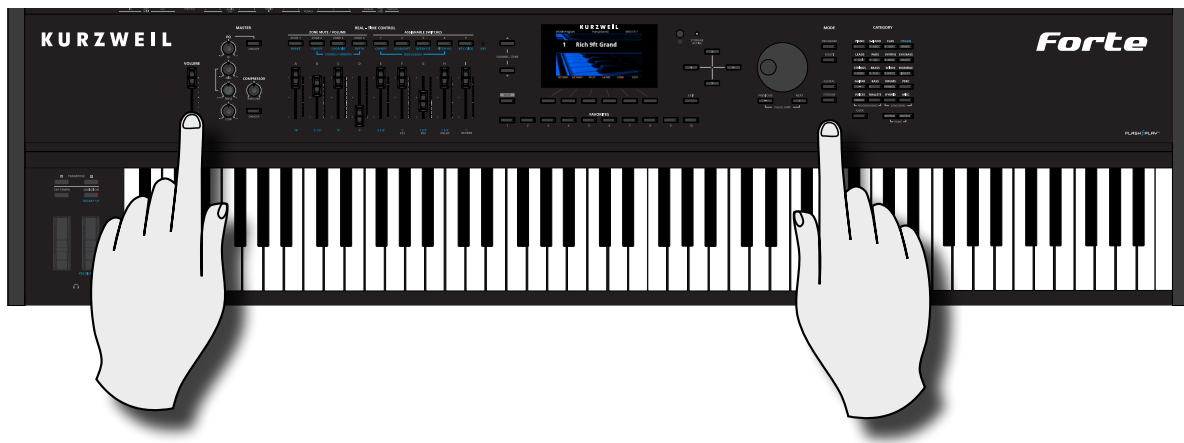

**Master Volume Slider**

**Mode Selection**

2. If you are connected to a mixing board and hear distortion, reduce the gain level on your mixing board, or use the pad (*a switch that decreases the input audio signal level, typically by 20dB*) if it has one.
3. To hear the capabilities of the Forte, you can play the demo songs. Press the Hybrid and Misc Category buttons simultaneously to listen to a demo song.
4. In Program Mode, scroll through the Programs using the Alpha Wheel, the Previous and Next buttons, or press a Category button to audition the sounds in the Forte. The Forte has short demos for each of the factory Programs. To hear a Program Demo for the current Program, press the Voices and Mallets Category buttons simultaneously.

# The Rear Panel

The power switch and most of the Forte connections are located on the rear panel.

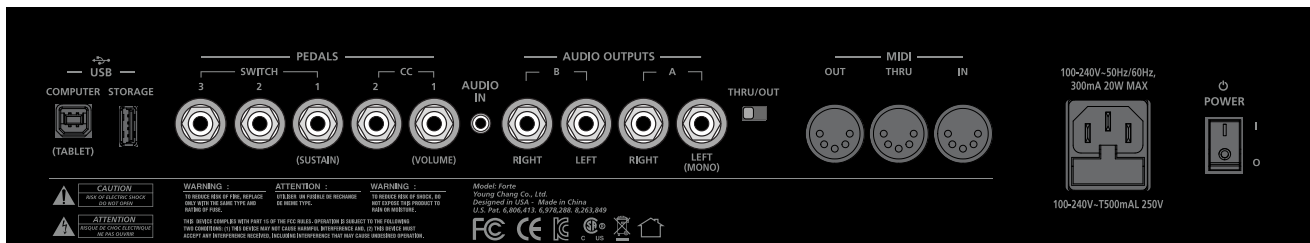

The headphone connection is not on the rear panel. It is located on the front left side of the Forte for easy access (*Underneath the Pitch & Modulation wheels*).

## The AC Power Jack

Please refer to “Setting up the Forte” on page 2-1.

## The USB Ports

Use the “Computer” USB ports to connect the Forte to a computer/tablet in order to do the following:

- Use the Forte as a MIDI controller to play software instruments on a computer.
- Use a computer program to sequence multitrack songs on the Forte.
- Use a computer/tablet to manage the user data contents of the Forte.
- Update the software and sounds of the Forte.

Use the “Storage” USB Port to store custom Programs and Multis on a USB flash drive.

Be sure to check the Kurzweil Music Systems website at [www.kurzweil.com](http://www.kurzweil.com) for new documentation and software updates before using your new instrument.

## The MIDI Ports (IN / THRU / OUT)

Use the MIDI ports to communicate with other MIDI modules and controllers. The Out port is the MIDI transmitting port, and the In port is the MIDI receiving port. Use the Thru port to pass MIDI data through the Forte to other instruments or modules.

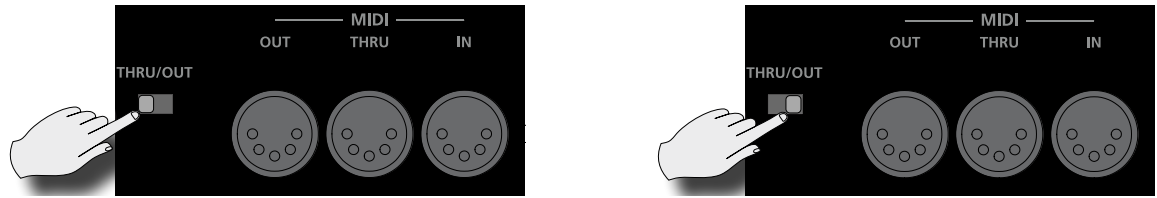

By sliding the switch on the rear panel from Thru to Out, the Forte sends MIDI Out messages on both the Thru and Out ports. The USB ports can also be used to transmit MIDI messages.

### Basic MIDI Hookup

To use the Forte as a MIDI controller for another sound module, use a MIDI cable to connect the MIDI port marked “OUT” to the MIDI input port of the module that you want to control.

To control the Forte using another MIDI controller, use a MIDI cable to connect the MIDI port marked “IN” to the MIDI output port of the controller that you will be using.

#### Using Forte MIDI Out

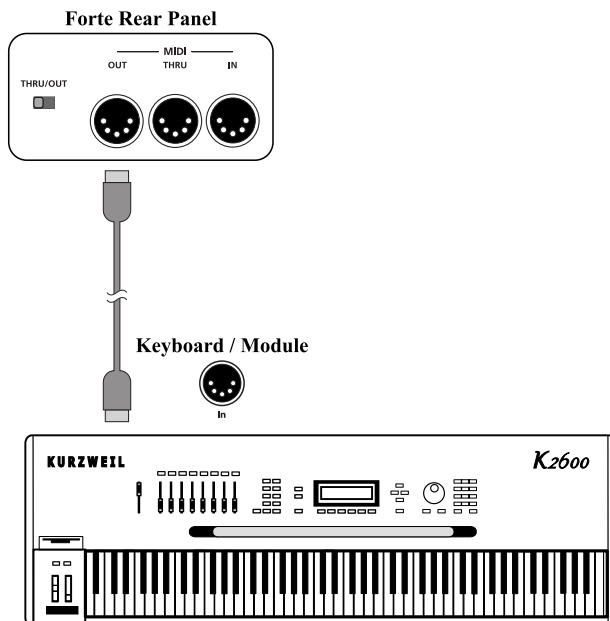

#### Using Forte MIDI In

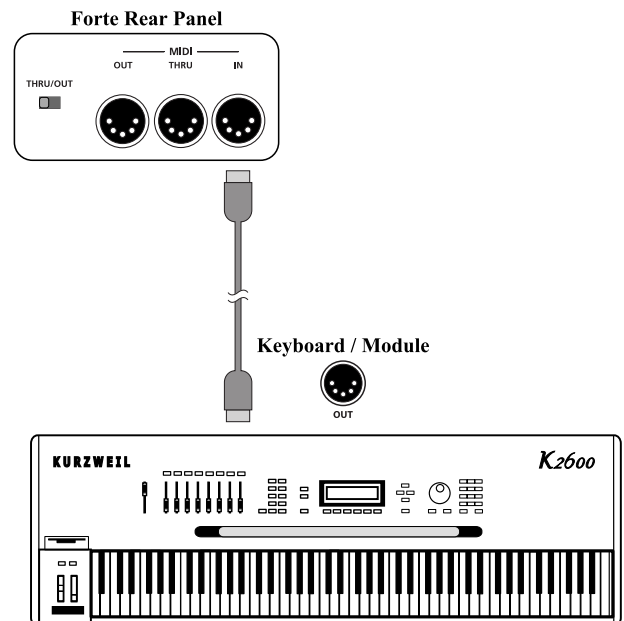

### Connecting More Sound Modules

In order to connect multiple sound modules to be controlled by a single MIDI controller, the Forte can either be :

- (1) Used as the controller.
- (2) Or as a module in the MIDI daisy chain.

## Getting Started

---

If the Forte is in the middle of the MIDI daisy chain, ensure that the MIDI Thru/Out selector is set to Thru.

### Scenario 1: Forte as the MIDI controller

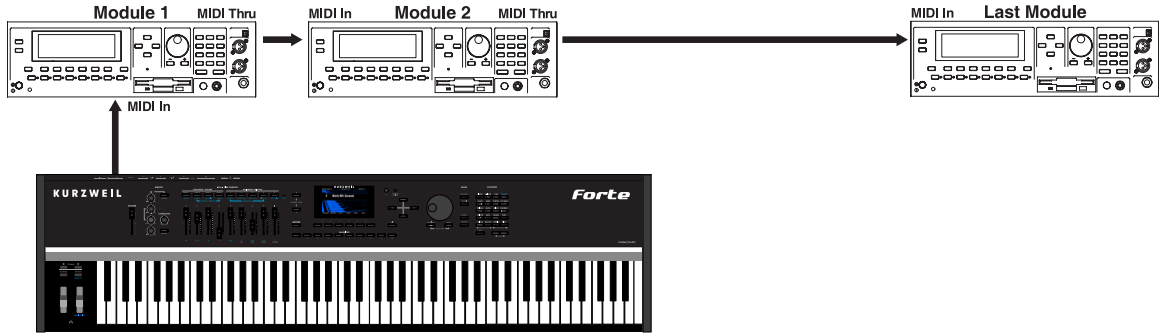

### Scenario 2: Forte as the last module in the MIDI chain

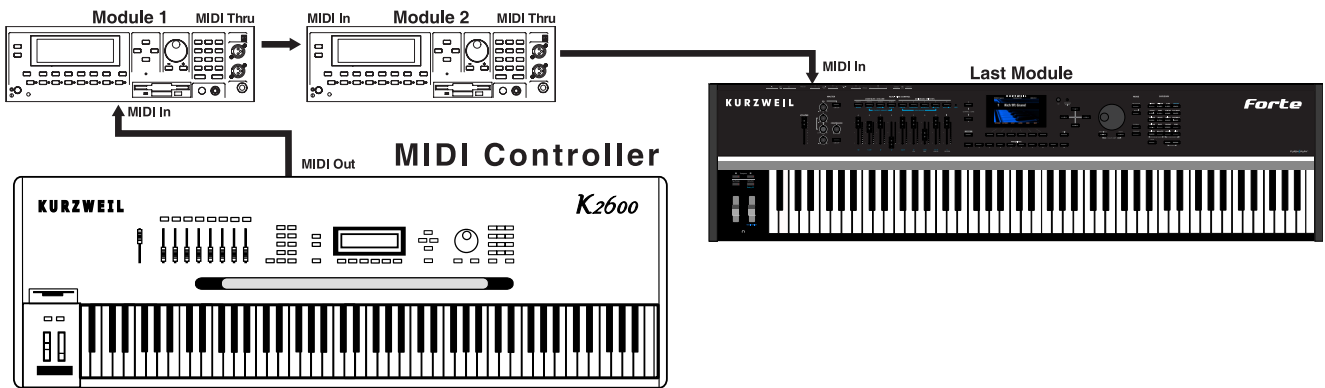

### Scenario 3: Forte in the middle of the MIDI chain

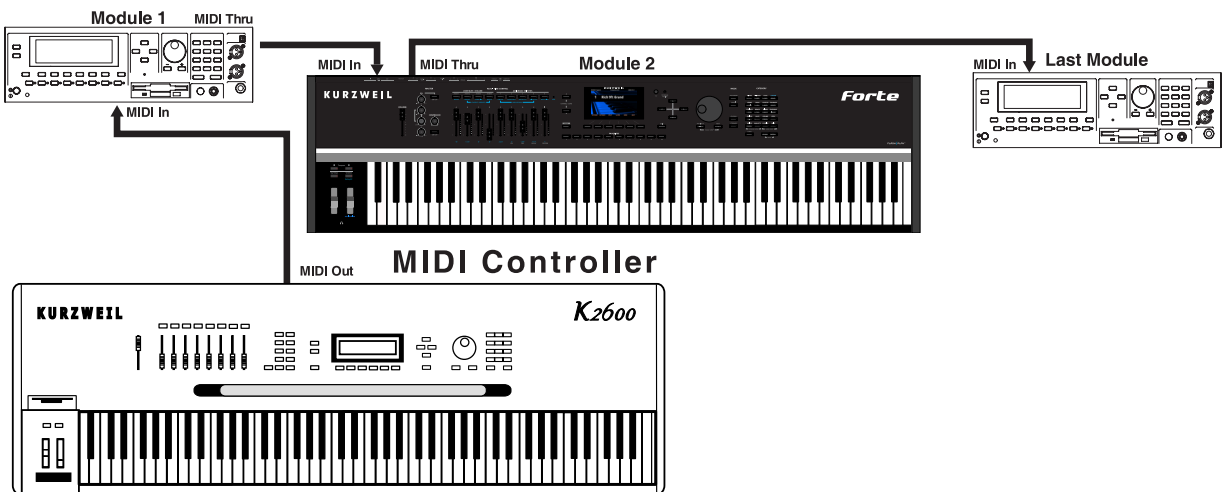

## The Pedal Jacks

Use the five pedal jacks to connect controller pedals to the Forte.

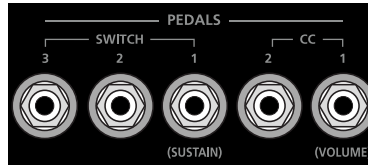

Although optional Kurzweil pedals are recommended, it is possible to use most switch or controller pedals that adhere to the following specifications.

<b>Switch Pedals</b>	1/4 inch tip-sleeve (mono) plug
<b>Continuous Control (CC) Pedals</b>	10-kOhm linear-taper potentiometer, 1/4 inch tip-ring-sleeve (stereo) plug with the wiper connected to the tip.

Pedals are all independently assignable within each Zone of every Multi.

On the back panel the Pedals are labeled as SWITCH 1/2/3, corresponding to the SW 1/2/3 labelling on the top panel. In this manual the Switch Pedals will be referred to as per the top panel (SW1, SW2 and SW3).



Here are the default control settings for the five pedals used by the Forte:

<b>Switch Pedal 1 (SW1)</b>	Sustain (MIDI 64)
<b>Switch Pedal 2 (SW2)</b>	Sostenuto (MIDI 66)
<b>Switch Pedal 3 (SW3)</b>	Soft (MIDI 67)
<b>CC Pedal 1 (CC1)</b>	Expression (Volume) (MIDI 11)
<b>CC Pedal 2 (CC2)</b>	Foot (MIDI 4)

### The SW1 (Sustain), SW2 and SW3 Jacks

Use the pedal jacks to connect switch pedals. A switch pedal is a physical controller typically used to control two-state (i.e., “on / off”) parameters, such as sustain, sostenuto, soft and Mute Zone.

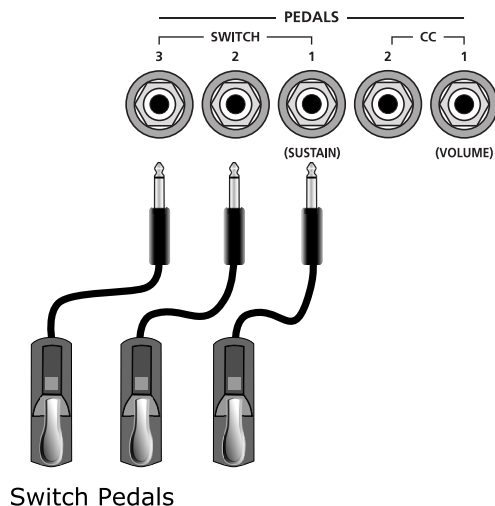

**NOTE : Do not to step on the switch pedals when powering up the Forte, as the state of the pedal is detected as part of the power up sequence.**

The Forte supports a single switch pedal or half-damper pedal on each of the SW1, SW2 and SW3 jacks.



**NOTE : It is not recommended to plug CC pedals into the SW inputs. Due to the flexible switch pedal support, CC pedals may not operate as expected in these inputs.**

If you are not using a Kurzweil switch pedal, make sure it's connected before you turn on the Forte. This ensures that the pedal will work properly (it might function in reverse—off when it's down and on when it's up—if you turn on your Forte before plugging in the pedal). Similarly, don't press any of your switch pedals while powering up, as the Forte verifies each pedal's orientation during power-up. If you're pressing a pedal, you might cause it to work in reverse.

### Connecting a Half Damper Pedal

Half Damper pedals where the wiper is connected to the tip (such as the KORG DS-1H™) can be connected to the SW1, SW2, and SW3 inputs on the rear panel. Some pedals have the wiper connected to the ring, and these pedals will require an adaptor to work with the Forte. When connected to the SW1 jack, a Half Damper pedal enables finer control of

sustain than a standard switch pedal. Half Damper control is enabled for programs in the Piano category. Programs outside of the Piano category will respond to Half Damper pedals as if they are standard switch pedals. Half Damper pedals can also be used to control external software and sound modules via MIDI.

### Connecting a Dual Switch Pedal

You can connect a dual switch pedal with a single stereo plug, such as the Kurzweil KFP-2S, into the SW1 and SW2 jacks. You will need a Y adapter with a stereo ¼-inch jack and two mono ¼-inch plugs. Plug the Y adapter into the SW1 and SW2 jacks, then connect the dual switch pedal to the Y adapter. If the Sustain and Sostenuto functions are swapped, then swap the two mono plugs.

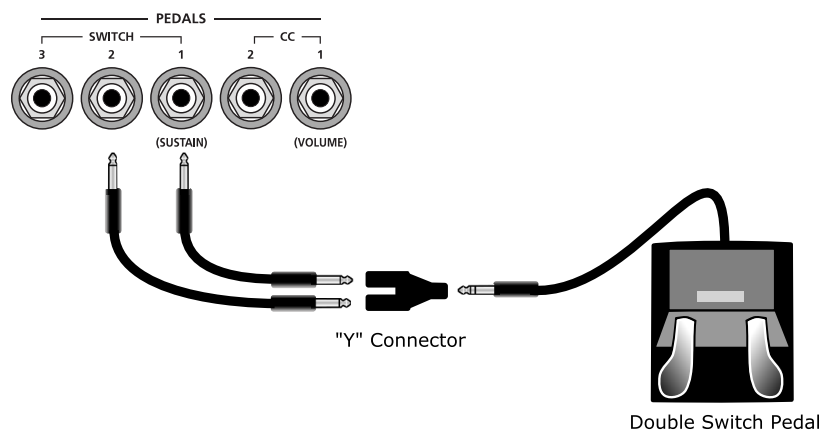

If you're not familiar with traditional piano technique, the sostenuto (center) pedal on a grand piano allows one to hold chords in the bass while continuing to play the melody without the latter notes sustaining. Any keys that are down when you depress the pedal will sustain when you let go of the keys, but new notes played afterward will not be sustained. Releasing the pedal puts things back to normal. Of course it can be programmed to do other functions as well.

### The CC1 (Volume) and CC2 Jacks

Use the CC pedal jacks to connect continuous control (or CC) pedals. A CC pedal is a physical controller typically used to control multi-state (i.e., “continuous”) parameters such as volume or wah.

The Kurzweil CC-1 continuous control pedal will work best with Forte, but it is also possible to use some third-party continuous control pedals designed for synthesizers.



**NOTE : Only CC pedals should be connected to the CC pedal input.**

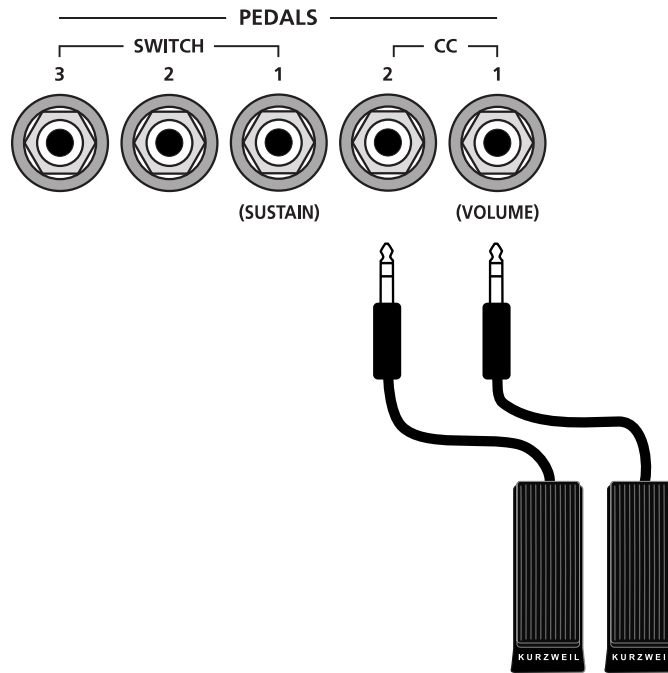

Continuous Control Pedals

## The Audio Jacks (A & B Audio Outputs)

Please refer to “Connecting to Your Audio System” below.

## The Headphones Jack

Use the Headphones jack to listen to the Forte on stereo headphones. The headphone jack is located at the front left of the instrument, under the Pitch & Modulation wheels.

You will need a 1/4-inch-to-1/8-inch adapter in order to use headphones that have a smaller mini plug connector.

## Connecting to Your Audio System

After you've turned down the level on your sound system, connect the Forte analog audio outputs to your sound system using a pair of balanced (TRS or "stereo") or unbalanced (TS or "mono") audio cables. Unbalanced cables will always work, but if you're going into balanced inputs, use balanced cables for a better signal-to-noise ratio and a bit more volume. The Forte analog outputs are balanced.

You'll find four 1/4-inch balanced audio output jacks on the rear panel, the "A" Audio Output pair and the "B" Output pair. Connect one end of each audio cable to the "A" Audio Output jacks found on the rear panel of the Forte marked "Left (Mono)" and "Right," and the other end to your mixing console or PA system inputs. If you have only one input available, use the Forte's Left (Mono) output to get the full signal in mono. Use the jack marked Headphones (located on the front/left of the instrument) to listen to Forte on headphones. When headphones are plugged in, sound still comes through the Left and Right audio jacks.

### Forte connected to powered speakers and headphones

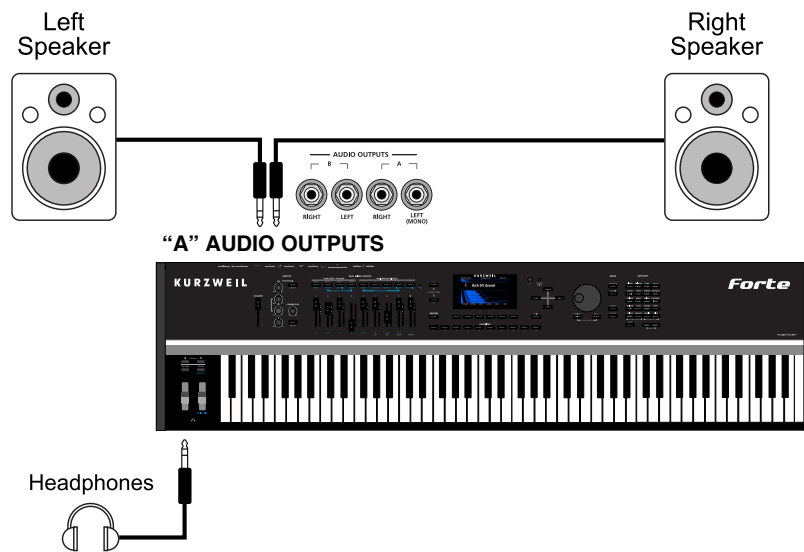

**Forte connected to a mixer, powered speakers and headphones**

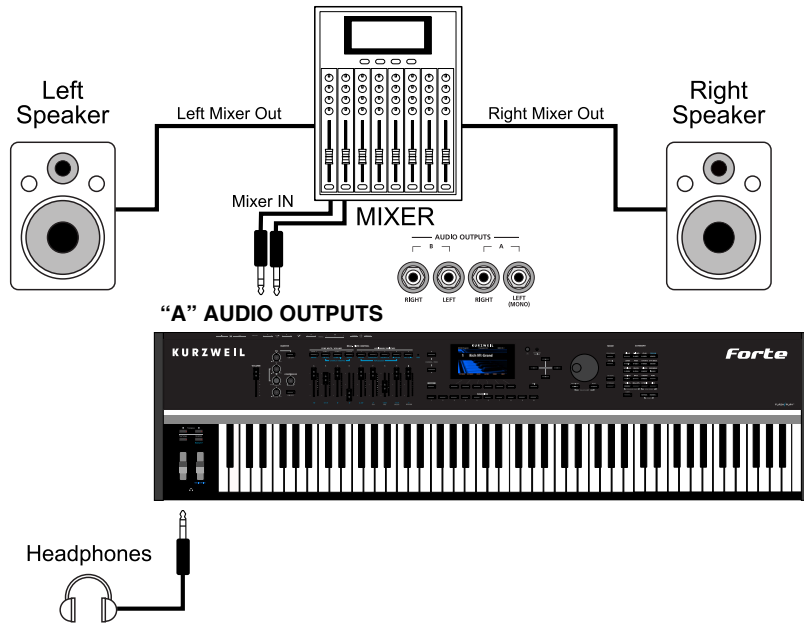

## Connecting to a Computer

To connect the Forte to a computer/tablet, simply connect the provided USB cable from the Forte's USB Computer (Tablet) port to a USB port on your computer. If you wish to use your own cable, make sure that it is a Type-A-to-Type-B USB cable (the USB Computer (Tablet) port of Forte being Type B).

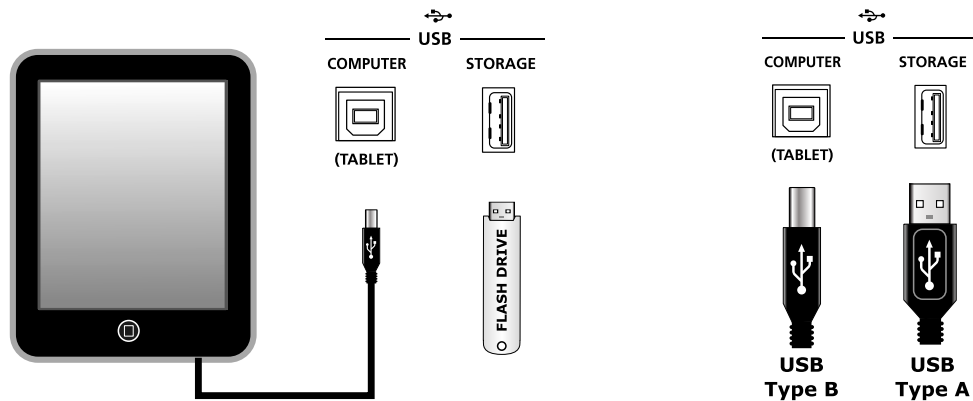

**NOTE :** Some devices like the iPad® will require you to purchase adaptors to connect a USB cable.

# Selecting Programs and Multis

The Forte supports two types of sounds. The first type is a Program, and these are normally a single instrument, such as a piano, or an organ. A Program is similar to a “preset” or “patch” on other synthesizers. The Forte has an extensive range of factory Programs, and additional memory for further user Programs. Both factory and user Programs are arranged into 20 categories.

The other type of sound is the more complex Multi. A Multi is a combination of Programs arranged as layers and splits across the keyboard. They are similar to setups, from the Kurzweil PC series, SP series and K2 series, and are similar to Combis or Multis from other synthesizers. The Forte has a range of factory Multis and additional memory for further user Multis.

The Forte has been designed so that it is quick and easy to select Programs and Multis from the front panel.

Use the following guide to audition the factory sounds on the Forte.

## Selecting Programs

The Forte always powers up in Program Mode, with selection by Category as the default. Use the Alpha Wheel or Previous/ Next buttons to browse programs in the current category. Each Category has a factory default program, generally the first in each Category. However, the user can set the Category default by selecting the desired program, pressing and holding the current Category button for a few seconds until the display indicates that the Category default program has been saved.

You can also enter specific program numbers in Keypad mode by pressing the Keypad button (the Keypad button LED will light) beneath the Category section. In this mode the Category buttons function like a standard alphanumeric keypad. In Keypad mode the list of Programs is sorted by ID number only, instead of by Category and ID. Using the Alpha Wheel or Previous/ Next buttons will select the previous or next used Program ID, regardless of category. To exit Keypad mode press the Keypad button again. The Keypad LED will turn off and the Forte reverts back to Category mode.

Another useful feature in the Forte is the ability to access a short demo song for the currently selected Program by Pressing the Voices and Mallets Category buttons simultaneously.

To return to Program Mode from a different mode, simply press the Program Mode button.

In Program Mode, pressing a Category button will select a Category Default Program for that Category. The Category Default Program can be set by the user for each Category. By default the Forte has the Category Default Program for each Category set to the first Program of each Category. To change the Category Default Program, first select the desired Program. Next, press and hold the Category button of the currently selected Category for a few seconds until the display indicates that the Category Default Program has been saved.

## Selecting Multis

To play a Multi, simply press the Multi Mode Button and the Multi Mode Button LED will light. Use the Alpha Wheel or Previous/Next Buttons to browse Multis, or enter a Multi ID number by using the Category buttons as a numeric keypad. Multis are not categorized, so the Keypad button's LED is always lit in Multi Mode and the Category buttons will always function as a numeric keypad.

## User Programs and Multis

In Program or Multi Mode, press the User button to view User edited Programs or Multis that you have saved or loaded to the Forte. The LED on the User button will light, you can then use the Alpha Wheel or Previous/Next buttons to scroll through only user Programs or Multis. Press the User button again to stop viewing only user Programs or Multis, or press a Category button or use keypad mode to enter a factory ID number.

## Controller Info

The Sliders, Wheels, Pedals and Switches can control each of the factory Programs and Multis, to produce variations to the sound. When one of these controls is used the Forte LCD will display information about the parameter that control is assigned to. Don't forget to try out these controls as you explore the factory sounds on the Forte.

## Favorites

The Forte also features Favorites Buttons to quickly recall your favorite sounds. The Favorites buttons store a set of 10 Programs and/or Multis. To assign the currently selected Program or Multi to a Favorites button, press and hold the desired Favorites button for a few seconds until the display indicates that the Favorite has been saved. To recall a Favorite Program or Multi, simply press one of the Favorites buttons. The Favorites buttons will work from whichever mode you are currently in, changing to Program Mode or Multi Mode automatically if required.

To view the names of Programs and Multis stored as favorites, press the View soft button until you see the Favorites listed at the bottom of the display. See "Favorites View and Favorites Banks" on page 6-9 for details.

# Modes

The Forte has six main modes; Program Mode, Program Edit, Multi Mode, Multi Edit, Global Mode and Storage Mode.

## Program Mode

The Forte always powers up in Program Mode, and this is where single sounds can be played straight from the keyboard, or multitimbrally via MIDI.

### Controller Conventions

Generally the factory Programs have the following controllers assigned.

Forte Controller Conventions

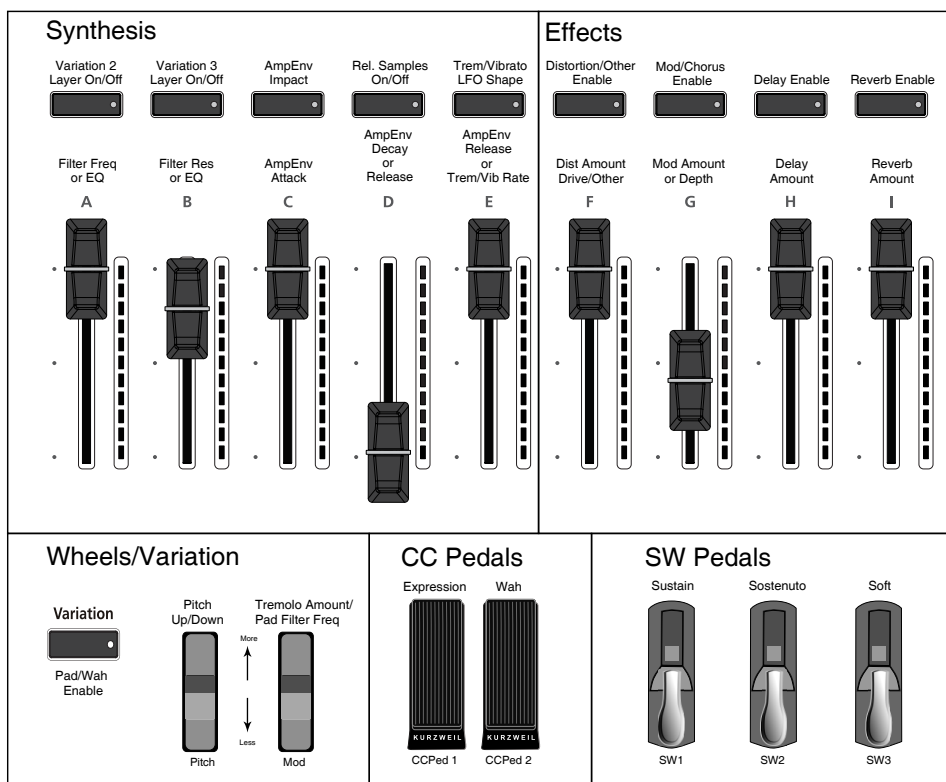

### Saving Programs

If you make changes to the current Program using any of the controllers (Sliders, Wheels or Switches), the Save button's LED lights to indicate that a change has been made to that Program. The Save button is located left of the display. To save a copy of the Program with the changes you've made, press the Save button once. The Save button's LED begins to blink and it calls up the Save Dialog. The Save Dialog allows you to choose an ID number and name that will be associated with the program you are saving.

## **Splits and Layers**

Programs can be Split into Multis, so that keys in one region of the keyboard play a different program than another region. Programs can also be Layered into Multis, so that more than one Program can be played by striking one key. Press the Split or Layer soft button to create a Split or Layer Multi containing the current Program. You will then be able to add up to three additional programs to create a Split or Layered Multi containing up to four Programs.

## **Program Edit Mode**

Program Edit Mode allows you to change the parameters of a Program and save a customized version as a user Program. Synthesis and effects parameters can be edited or assigned to controllers. Also, Insert and Aux effects Chains can be selected.

## **Multi Mode**

Multi mode allows you to play Multis, which are arrangements of up to 4 Programs split and/or layered in Zones across selected ranges of the keyboard. The volume of the Program in each Zone can be easily adjusted while you are playing by using sliders A through D, and each Zone can be muted and enabled by using the Zone Mute buttons above these sliders. You can create custom assignments for the remaining sliders, buttons and foot controllers to control effects and synthesis parameters of each Program.

## **Multi Edit Mode**

Multi Edit Mode is used to modify the many parameters that make up Multis, including Program Selection, Volume, Pan, Controller assignments, effects and the layering and split options. Multi Edit Mode allows for powerful customizations of the many built in sounds available on Forte and allows you to make new and unique sound combinations for your own performances and compositions.

## **Global Mode**

Global Mode gives you access to the global parameters of the Forte. It allows you to edit the master settings of the unit. It also allows you to restore factory defaults on the unit by performing a Hard Reset. Some of the more common settings are summarized below.

### **MIDI Settings**

MIDI channels, modes and other parameters related to transmitting and receiving MIDI are set within the MIDI pages.

### **Info**

The Info page displays the currently installed operating system and object versions. Use this page to check if your Forte is up to date with the most recent software and sounds posted at [kurzweil.com](http://kurzweil.com).

### System Reset

In the unlikely event that something goes wrong with the settings or software of your Forte, or if you just want to start fresh, you can return the Forte to the factory default state by doing a System Reset.



**NOTE : System Reset will erase ALL of the USER Programs and Multis, so it is important to back up your sounds before attempting to reset Forte. Factory Program/Multis are not affected.**

## Storage Mode

Storage Mode facilitates loading and saving objects for the Forte.

### Saving to External Storage

Programs and Multis that you have created can be saved to a USB Flash Drive or a computer/tablet.

### Loading from External Storage

Programs and Multis can be loaded onto the Forte from USB Flash Drives or a computer/tablet. This allows you to load new sounds from Kurzweil or other developers, or to load sounds that you have previously saved.

## Updating the Forte

Please check online at [www.kurzweil.com](http://www.kurzweil.com) for Forte updates. Detailed instructions on updating the Forte are available with the update package. It is important that these instructions are followed closely for trouble free updating of the Forte. This manual was written for Forte software release v1.21 and OS 3.21.23952. See the Info page in Global mode to check the currently installed OS version.

# Chapter 3

## Features of the Forte

This chapter will help familiarize you with the features of the Forte. Many of these features have both general functions and mode-specific functions. For more in-depth descriptions of these features, refer to the chapters on the individual modes.

### Powering Up Defaults

In general, the Forte will always remember the last selection made by the user. However, powering up the Forte resets some of these settings back to their power-on defaults.

#### Parameters Reset To Defaults At Power-On

- Transpose set to 0 semitones.

#### Parameters Remembered After Power-On

- Currently selected MIDI Channel in Program Mode.\*
- Currently selected Program per MIDI Channel in Program Mode.\*
- Currently selected Multi.\*
- User Programs.
- User Multis.
- Favorites.
- Default Program per Category.
- Master EQ & Compressor switch settings.\*
- Global Mode parameters.\*
- Display View Mode.\*

---

\* *Must exit Global Mode to save settings.*

# The Front Panel

All the controls for Forte, both musical and navigational, are on its front panel

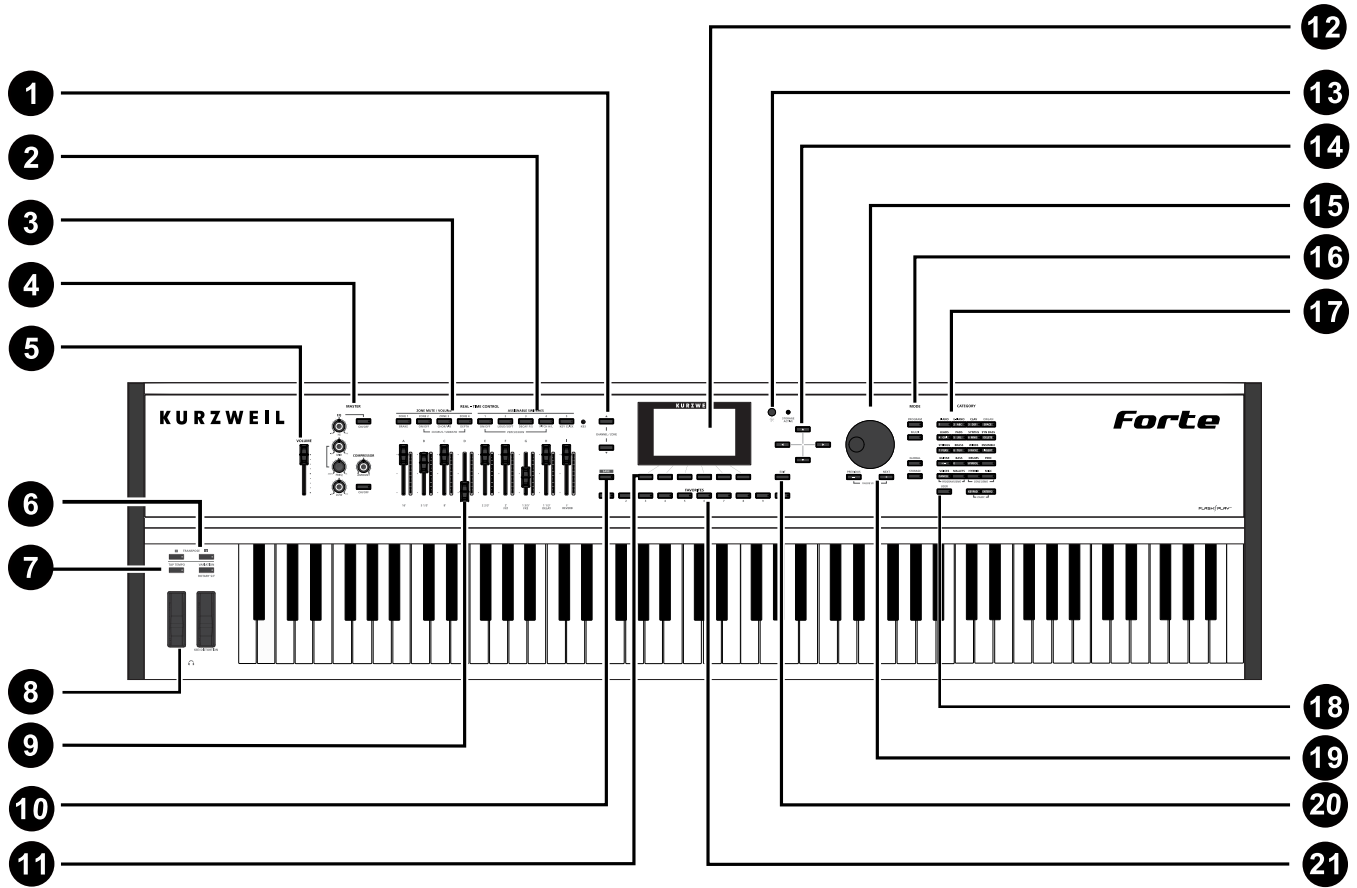

1	Channel/Zone buttons
2	Five programmable switches
3	Multi Zone mute buttons
4	Master EQ/Compressor
5	Volume slider
6	Transpose buttons
7	Tap Tempo & Variation buttons
8	Pitch & Modulation wheels
9	Nine programmable sliders
10	Save button
11	Soft Buttons

12	LCD display
13	LCD brightness adjust
14	Navigation Buttons
15	Rotary dial (Alpha wheel)
16	Mode buttons
17	Category buttons
18	User button
19	Previous/Next buttons
20	Exit button
21	Favorites buttons

---

## Pitch and Modulation Wheels

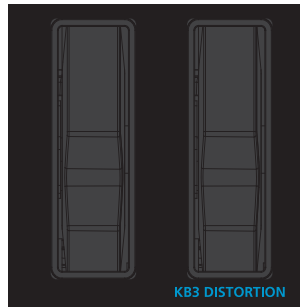

### Pitch Wheel

The Pitch Wheel is the left most of the two wheels. It is spring-loaded, such that its center position is restored when it is not being used. That is because the Pitch Wheel is used for pitch-bending notes—its “off” position is in the center. Pushing the Pitch Wheel up bends the pitches of all notes up. Pulling the Pitch Wheel down bends the pitches of all notes down.

For some Programs the Pitch Wheel will not bend notes that are held by the sustain pedal. This is how many Guitar and Bass Programs are configured, allowing played notes to be bent over sustained notes.

For User Programs, you can program the bend amount for the Pitch Wheel using the BendRange Up and BendRange Down parameters on the EDIT: “COMMON Page” on page 7-10.

For User Multis, you can program the bend amount for the Pitch Wheel using the Bend Up ST/Bend Up Ct and Bend Down ST/Bend Down Ct parameters on page 9-13.

### Modulation Wheel

The Modulation Wheel is the right most of the two wheels. Unlike the Pitch Wheel, the Modulation Wheel is not spring loaded, and can be set to and left in any position between fully up and fully down. Typically, the Modulation Wheel is assigned to a parameter that alters some aspect of the sound (e.g., vibrato, filter depth) when changed.

When a KB3 Program is in use, the Modulation Wheel is assigned to control distortion.

# Real Time Control

Forte Controller Conventions

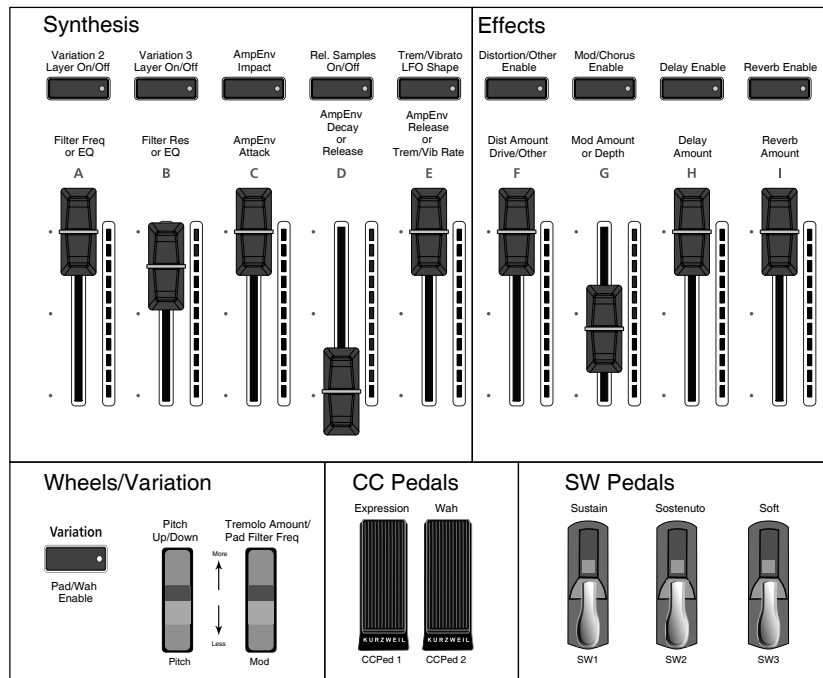

## Sliders

The nine sliders on the left of the front panel are assigned to control different sound parameters and effects for each Program. In Multi Mode, Sliders A-D default to controlling volume for Zones 1-4. The sliders can also send MIDI continuous controller values to external MIDI equipment. Each slider has a handy visual LED ladder that indicates its current setting when a new Program or Multi is selected.

In Program Mode, most programs have Slider A assigned to a filter or EQ parameter in order to control the brightness of the sound. In all Programs and most Multis, Slider I controls reverb amount, while Slider H usually controls a second effect, such as delay/echo amount. The remaining sliders have different assignments depending on the selected Program/Multi. See the Controller Conventions diagram above for controller assignments commonly used by Programs.

If you select a KB3 Program, the nine sliders act like tonewheel organ drawbars. The labeling below the sliders applies to the KB3 Programs, indicating the drawbar registers that are modified by the slider.

For KB3 Programs, the sliders operate in a similar way to a Hammond organ, i.e. pulling the slider towards you increases the drawbar amount. To help illustrate this, the Forte inverts the LED ladders to indicate the drawbar (slider) position.

For standard Programs the sliders have the minimum value when they are towards the player and maximum value when they are pushed away from the player.

### LED Ladders

The LED Ladders show the current value of the slider. When you change Programs or Multis the LED Ladders show the default value of the parameter assigned to the slider, which may differ from the current physical position of the slider.

## Zone Mute/Volume Buttons

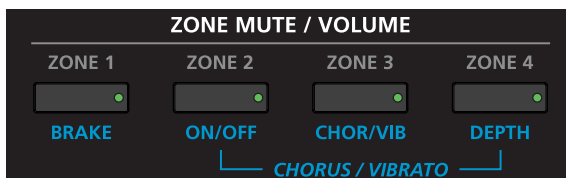

Zones are the independent regions of the keyboard that make up a Multi, for additional information see “About Zones” on page 8-6.

Pressing a Zone button will mute or unmute the Zone. An active/unmuted Zone button has a lit green LED. The LED of an inactive/muted Zone button is not lit.

In Program Mode the Zone buttons can be used as additional switches to control parameters of a Program. They are identified in the Program PARAMS page as zone switches. When active in Program Mode it has a lit red LED. When inactive, it is not lit.

## Switches

In Program Mode, the five Switch buttons are pre-assigned to change the sound in different ways. Factory programs generally use these switches to enable effects. Switch assignments can also be changed in Program Edit mode.

In Multi Mode, you can assign the Switch buttons to control Program and effects parameters, or send MIDI CC messages to external equipment.

The Switch Button LEDs illuminate red when the switch is active.

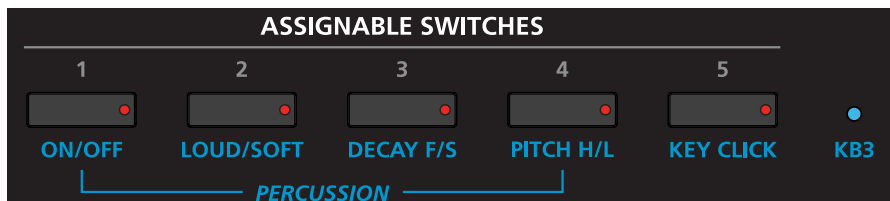

### Foot Switches and Controllers

The Forte can support up to 3 Switch or Half Damper pedals as well as 2 Continuous Controller (CC) pedals. By default the Switch pedals control Sustain, Sostenuto, and Soft Pedal. The CC pedals control expression (program volume) and wah (if applicable) by default. Each pedal can also be assigned to a different function per Program or per Multi zone, or a Global mode pedal override can be set to change the default pedal functions for all Programs/Multis.

### KB3 Buttons

For KB3 Programs, these buttons manipulate the KB3 sound, as per the blue labels below the button. When the LED of the button is red, the KB3 function is active.

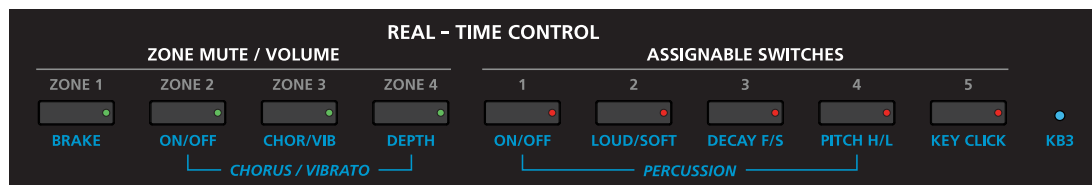

### Transpose Buttons

The Transpose and Variation buttons are located at the very end of the left side of the Forte keyboard, just above the Pitch & Modulation Wheels.

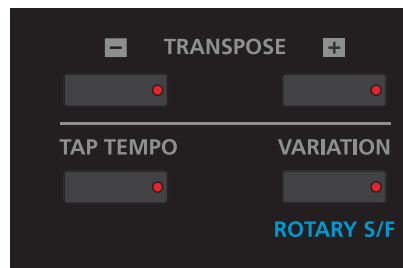

The Transpose buttons can be used to change the tuning of notes played on the Forte keyboard in semitones (ST), also known as half steps. This is a convenient way to change the key of a song without learning to play it in a different key. The Transpose buttons are located to the left of the keyboard, above the Pitch and Mod Wheels. The Transpose buttons also transpose MIDI notes sent to the USB and MIDI out ports.

Press the Transpose - or + buttons to transpose the Forte keyboard down or up by one semitone. The top line of the display shows the current transposition value. Pressing both Transpose - and + simultaneously will reset the transposition to 0. To transpose up and down by octave intervals (12 ST), press the OCTAVE- and OCTAVE+ soft buttons underneath the display.

The maximum transposition value possible is +/-36 semitones.

The LEDs of the Transpose buttons indicate whether the current Program is transposed up (Transpose + LED is lit) or transposed down (Transpose – LED is lit). When there is no transposition, neither Transpose button is lit.

## Variation Button

The Variation Button is a MIDI controller (default MIDI CC#29) that is programmed in most Programs to modify the sound, such as adding a pad sound, changing the effects or some other variation suited to changing with a switch.

For KB3 programs, the Variation Button controls the Rotary Speaker speed, switching between fast and slow.

## Tap Tempo Button

The Tap Tempo button is a dedicated button you can use in any mode to set the Forte's tempo. When the button is being tapped to set the tempo, a message appears on the screen indicating the current tempo. The message will disappear after a few seconds. The Tap Tempo button is useful for controlling the rate of tempo synced effects, such as Delay. Many factory Programs use effects Chains containing tempo synced effects.

## Save Button

The Save button is located beneath the “Save” label on the left side of the LCD screen.



In Program Mode, pressing the Save button saves the current position of the sliders, switches and wheels as a User Program. (See Save User Programs on page 6-24.)

In Multi Mode, pressing the Save button saves a copy of the current Multi. The copy is saved with the states of the Multi Zone Mute buttons but does not include the current state of the physical controllers (i.e. moved Sliders, Mod Wheel etc.). Other controller states can be edited in Multi Edit Mode. (See Saving a User Multi on page 8-18).

The Save button's LED is illuminated once you have made changes to the current Program or Multi to indicate that the Program or Multi has changed.

# Master EQ & Compressor

## Master EQ

The Master EQ allows you to have realtime control over the frequency response of all audio generated in either Program or Multi Modes. When the Master EQ On/Off button is “On”, the rotary knobs can change the high, middle and low frequencies of the audio.

If the LED on the Master EQ On/Off button is lit, this indicates that the Master EQ section is now “on”.

The HI and LOW EQ’s are shelving type filters, and the MID has an adjustable center frequency with a range of approximately 2 octaves up and down centered around approximately 1.4 kHz

	Frequency	Gain
<b>HI</b>	~6.6 kHz	-24dB to +15dB
<b>MID*</b>	~1.4 kHz	-24dB to +15dB
<b>LOW</b>	98 Hz	-24dB to +15dB

\* center of range



## Compressor

Use the Master Compressor to add compression to all audio generated in either Program or Multi Modes. Press the Compressor On/Off switch to enable the master compressor. If the LED on the Master Compressor On/Off button is lit, this indicates that the Master Compressor is now “on”. Turn the Compressor knob to adjust the amount of compression (left is minimum, right is maximum).

Generally, a compressor listens to an audio input signal and outputs a continuously volume adjusted version of the input signal. A small amount of compression can help a sound to blend with a band or other instruments by making the volume of each note more consistent. Large amounts of compression act more like a special effect, reducing the attack volume of notes, and increasing the decay, sustain and release volume of notes.

The Master EQ and Compressor are arranged in the signal chain as per the diagram below. While it is not possible to swap the order of the compressor and Master EQ either or both of these effects can be bypassed by using the relevant On/Off button.

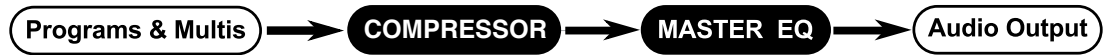

# Audio In

On the back panel of the Forte you will find a 1/8" sized stereo audio jack labelled AUDIO IN.

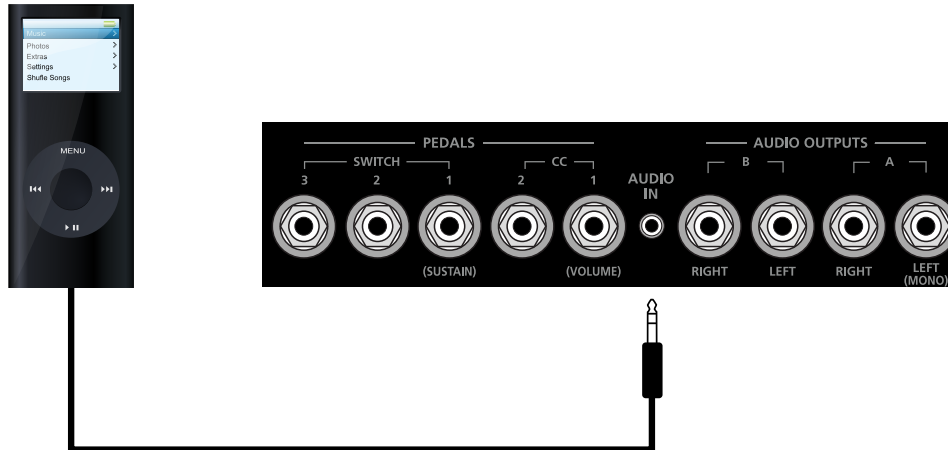

You can plug your MP3 player into the Forte and play along with the recorded music. There is no volume control for the Audio Input on the Forte itself, so you should control the mix volume of the Audio Input from the MP3 player itself.

By default the audio input on Forte is Off.

To turn it On you will need to go to Global Mode on the MAIN1 page and set the “Audio Input” parameter to On.

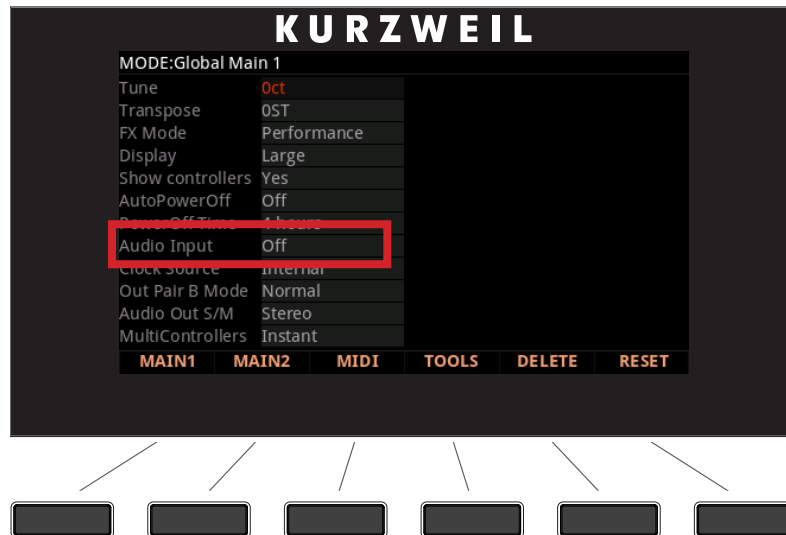

## Mode Buttons

The Mode buttons are located beneath the “Mode” label on the right side of the Forte front panel.



### Program Button

Pressing the Program button enters Program Mode (described in Program Mode on page page 5-1 and, in further detail, in Program Mode on page page 6-1). In Program Mode, you can select and play different sounds (or “Programs”). This button’s LED is illuminated when you are in Program Mode. Program Mode is the default Mode — the Forte always boots up in this Mode.

### Multi Button

Pressing the Multi button enters Multi Mode (described in Multi Mode on page page 5-2 and, in further detail, in Multi Mode on page 8-1). In Multi Mode, you can select different configurations of Programs, controller assignments, and MIDI channel assignments.

This button’s LED is illuminated when you are in Multi Mode.

### Global Button

Pressing the Global button enters Global Mode (described in Global Mode on page 5-2 and, in further detail, in Global Mode on page 10-1). In Global Mode, you can edit parameters that control the overall behavior of the Forte. These parameters include tuning, transposition and velocity as well as being able to reset the Forte back to a factory state.

This button’s LED is illuminated when you are in Global Mode.



**CAUTION: Performing a Reset will erase ALL User Program and User Multis, and will reset Global settings to a factory state.**

# Navigation

The navigation section of the Forte front panel includes the LCD display, Previous & Next buttons, Channel / Zone buttons, and the Alpha Wheel.



## The Color LCD Display

The Forte features a high resolution color LCD display to present information and user changeable parameters.

In Program and Multi Mode, the top line of the display shows the current Mode, MIDI transposition, MIDI In/Out activity indicators, and MIDI channel (Program Mode only). The middle section of the display shows the current Program or Multi ID number and name, along with the Category name (Program Mode only) and background image. In Program Edit mode, the top line of the display shows the current mode and page name.

In Program and Multi modes, you can use the VIEW soft button to switch between three view modes: “Large” (default), “List”, and “Favorites”. By default, Large and Favorites view will also display controller parameter assignments when a controller is moved (Sliders, Switch buttons, Mod Wheel, and Pedals). Displaying controller parameter assignments can be disabled by using the Global Mode “Show Controllers” parameter.

In Multi Edit Mode, the top line of the display shows the current mode and page name. On the Multi Edit Main page and Controls page, the top line of the display also shows currently selected Zone number.

In Global Mode, the top line of the display shows the current mode and page name. The bottom line of the display shows the names of the Soft Buttons for the current page.

## Previous (–) and Next (+) Value Buttons

Use the Previous and Next buttons to scroll through the list of values for the currently selected parameter. Pressing both the Previous and Next buttons simultaneously is referred to as the Value Jump double button press. Depending on the selected parameter, Value Jump can select the next Category default Program/Multi, jump to commonly used values, and reset parameters to default values. For more information, see Value Jump on page 3-16.

## Channel / Zone Buttons

In Program Mode, pressing the Channel / Zone Up button will change the MIDI transmit channel from the current channel to the next one; pressing the Channel / Zone Down button will change the MIDI transmit channel from the current channel to the previous one.

The top line of the display shows the current MIDI transmit channel. When the highest or lowest MIDI transmit channel is reached, the list will wrap back to the first or last MIDI transmit channel respectively.

Pressing the Channel / Zone up down buttons simultaneously in Program Mode will reset the MIDI Channel to 1.

In Program and Multi Mode, if Favorites view is selected and the Global Mode User Type parameter has been set to Advanced, the Channel / Zone up/down buttons will cycle through 16 banks of 10 favorite Programs/Multis. The current Favorites Bank number is displayed in the upper right hand corner of the screen.

In Multi Edit mode, pressing the Channel / Zone buttons will change the currently selected Zone on the Main page & Controls page.



**NOTE : The Channel / Zone buttons are not used in Global Mode.**

## Alpha Wheel

Use the Alpha Wheel to scroll through the list of values for the currently selected parameter—turning the Alpha Wheel counter-clockwise will select the previous value and turning the Alpha Wheel clockwise will select the next value. You can turn the Alpha Wheel slowly to change the value by one increment or turn it quickly to jump several increments.

## Display Brightness Knob

You can adjust the display brightness by turning this small knob.

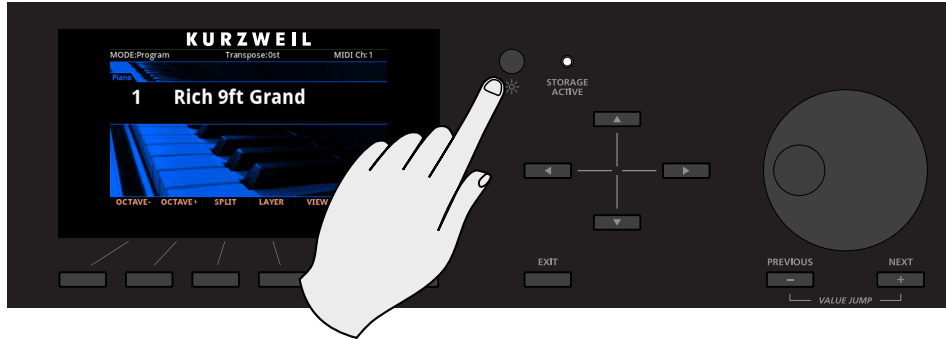

## KB3 LED

The KB3 LED is on the right side of the Assignable Switches.

If the currently selected Program is a KB3 program, the KB3 button's blue LED is lit. This indicates that the front panel KB3 controls (printed in blue) are active.

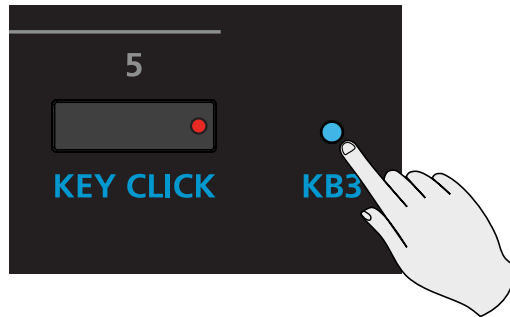

## Category & Keypad

Depending on what mode you are in, the Category buttons on the Forte can be used for selecting sounds via their category, or can be used as a numeric keypad for data entry.

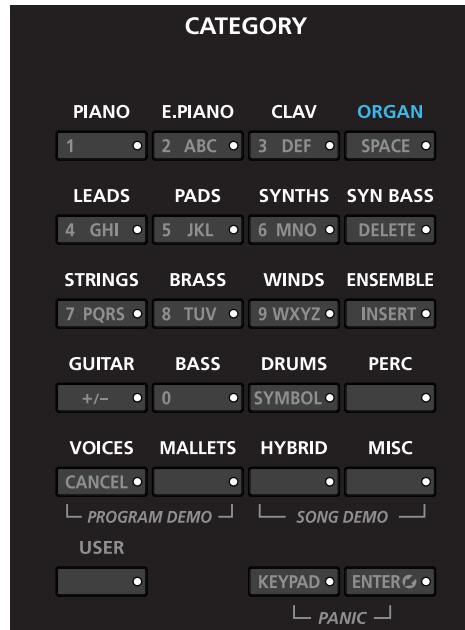

### Category

The Forte makes it easy to select sounds by instrument type in Program mode. The 20 Category buttons are clearly labelled for you to choose easily. If a Category button is lit, you are currently in that selected Category.

Also, while in Multi Edit Mode with the Zone Program selected, the Category buttons will behave as they do in Program mode allowing you to select sounds by Category.

### Keypad

In Program Mode, press the Keypad button to toggle between Category and Keypad functionality. If the Keypad button LED is lit, the category buttons will function as a numeric keypad. In Program Mode you can use the keypad function to select a Program by typing an ID number followed by the Enter button. The white print on the Category buttons indicates their secondary alphanumeric functions when used for data entry.

If the Keypad button LED is lit in Program Mode, the list of Programs is sorted by ID number only, instead of by Category and ID. Using the Alpha Wheel or Previous/ Next buttons will select the previous or next used Program ID, regardless of category.

When saving files with Forte, or naming your Programs & Multis, the +/- button switches the alphanumeric buttons between lowercase and uppercase text.

## Double Button Presses

Several pairs of the buttons on the Forte have time-saving secondary functions when pressed simultaneously—think of them as keyboard shortcuts. For convenience of reference, descriptions of all of the double-button press functions appear below.

### Value Jump

In Program Mode, the Value Jump double button press selects the first Program of each Category, as well as the Category Default Program of each Category (if a Category Default Program has been set).

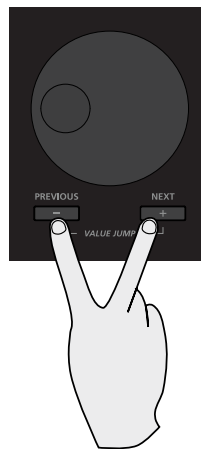

For more information on choosing a new Category Default Program, see page 6-8.

In Multi Edit Mode, pressing the Value Jump double button press resets the current parameter to its default value, or jumps between multiple useful values.

### Channel / Zone Jump

In Program Mode, pressing both the Channel / Zone Up and the Channel / Zone Down button resets the current MIDI channel to 1.



## Reset Transposition

Pressing both Transpose + and Transpose - , or Octave + and Octave - (Soft Buttons) simultaneously will restore the current Program or Multi to having no transposition.

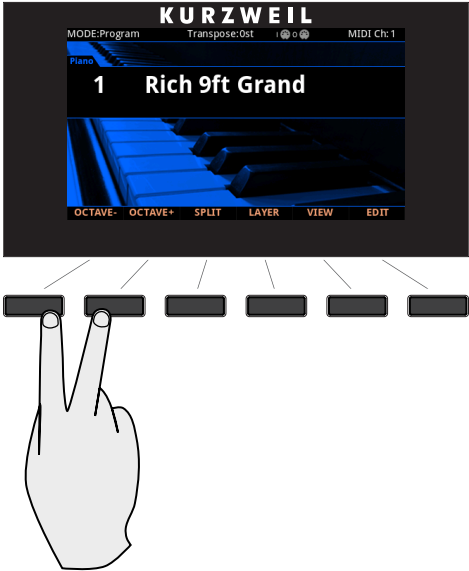
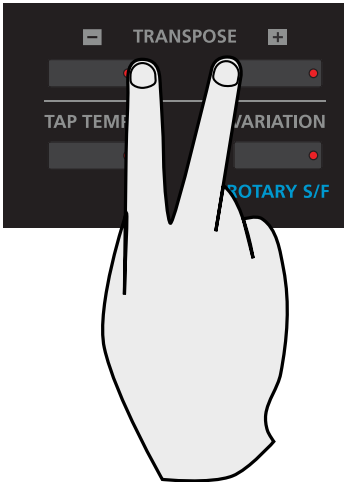

## Program Demo

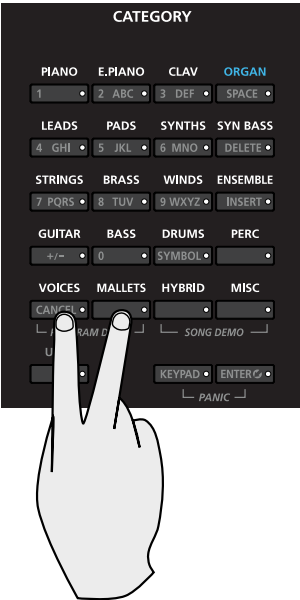

In Program Mode only, pressing the Voices & Mallets Category keypad buttons performs the Program Demo Function. The Program Demo Function plays the demo song for the currently selected Program.

The Voices & Mallets Category keypad button LEDs blink when using the Program Demo Function.

If you press these buttons from any other Mode, the display will give you a message indicating you are not in Program Mode.

Press the Cancel soft button to exit the Program Demo.

A label below the Voices & Mallets Category indicates the Program Demo double button press.

## Song Demo

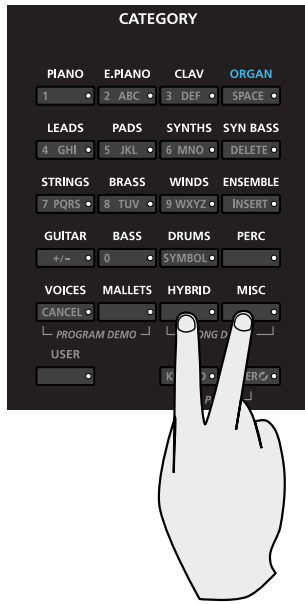

Pressing the Hybrid & Misc Category keypad buttons performs the Song Demo Function (described in further detail in Song Demo Function on page 3-17). With the Song Demo Function selected, you can hear a demonstration song that showcases many of the features of Forte.

A label below the Hybrid & Misc Category keypad buttons indicates the Song Demo double button press.

## Panic

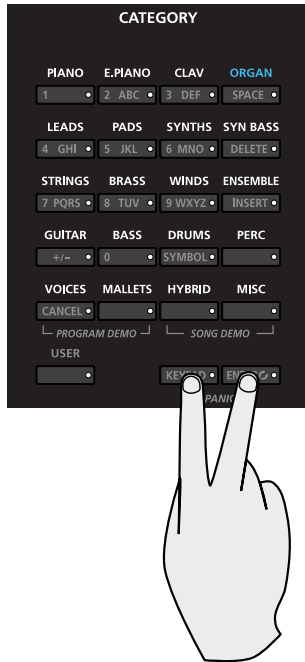

Pressing the Keypad & Enter keypad buttons simultaneously deactivates all sounding notes and control messages and sends an “all notes off” message and an “all controllers off” message on all 16 MIDI channels.

A label below the Keypad & Enter buttons indicates the Panic double button press.



# Chapter 4

## Terminology

This chapter provides definitions and descriptions for all of the Forte-specific terms used in this manual. Some of the terms are also used by other manufacturers.

Since there are no standard definitions for some of these terms, they are described here to avoid confusion. All of these terms appear with the first letter capitalized as proper nouns in this manual to make it easy to distinguish between the generic term and the Forte-specific term.

In addition to the terms below, and to avoid confusion, any Forte-specific feature, connector or control will have the first letter capitalized to distinguish it from the generic term.

<b>Program</b>	<p>A Program is an instrument sound that plays on a MIDI channel. The sound of each Program can be modified by parameters that are assigned to the controllers (Sliders, Switch Buttons, Mod Wheel, and Pedals).</p> <p>See Program Mode on page 6-1 for more information on Programs.</p>
<b>Multi</b>	<p>A Multi allows up to 4 instrument sounds (Programs) to be played from the keyboard at once. A Multi has 4 Zones, each with its own keyboard range, Program, MIDI channel, and controller assignments.</p> <p>See Multi Mode on page 8-1 for more information on Multis.</p>
<b>KB3</b>	<p>Kurzweil's organ-modeling simulation of the original Hammond B3 with Leslie rotary speaker emulation.</p>

## Terminology

---

<b>Zone</b>	<p>A keyboard region of a Multi that has its own Program, MIDI channel, and controller assignments.</p> <p>See About Zones on page 8-6 for more information on Zones.</p>
<b>Split</b>	<p>A Split is a Multi containing at least two Zones that have keyboard ranges that don't overlap. This allows different keyboard ranges to play different instrument sounds.</p> <p>See The Split Function on page 8-9 for more information on Splits.</p>
<b>Layer</b>	<p>A Layer is a Multi containing at least two Zones that have overlapping keyboard ranges. This allows a single keyboard range to play multiple instrument sounds.</p> <p>See The Layer Function on page 8-12 for more information on Layers.</p>
<b>MIDI Bank</b>	<p>A group of 128 Programs that can be navigated by MIDI compatible software or hardware.</p>
<b>Mode</b>	<p>An operating status with a unique group of operations.</p> <p>See The Operating Modes on page 5-1 for more information on Modes.</p>
<b>Pressure</b>	<p>Pressure applied to keys after a note is struck. It is also known as aftertouch, channel pressure, or mono pressure in other keyboards.</p>
<b>Reset</b>	<p>A process that returns Forte back to a Factory state. All User Programs and User Multis are erased. All Global Mode parameters are reset back to their default settings as well.</p>
<b>Factory State</b>	<p>The Factory State is the initial state of the Forte's Objects and Global Mode parameters when first purchased, or after performing a Reset.</p>
<b>Object</b>	<p>Anything that can be named, saved, deleted, or edited (i.e., a Program or a Multi).</p>
<b>KUF file</b>	<p>KUF (Kurzweil Unified File) file is a special file that has the objects and operating system combined that is used to update the Forte.</p>

# Chapter 5

## The Operating Modes

This chapter will help familiarize you with the operating Modes of the Forte.

Each of the six Modes (Program, Program Edit, Multi, Multi Edit, Global, Storage) has its own individual chapter.

The four Functions (Split, Layer, Program Demo, and Song Demo) are described in this chapter in “Functions” on page 5-5.

### Program Mode

Program Mode is the default Mode for the Forte.

In Program Mode, instrument sounds (Programs) can be selected and played. The sound of each Program can be modified by parameters that are assigned to the controllers (Sliders, Assignable Switch buttons, Zone buttons, Mod Wheel, and Pedals). Modified Programs can be saved as User Programs by pressing the Save button.

To enter Program Mode from another Mode, press the Program Mode button.

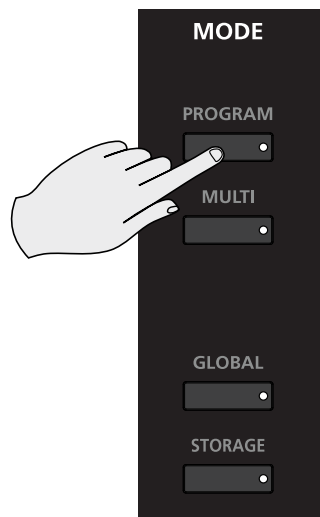

---

For more detailed information on Program Mode, see Program Mode on page 6-1.

## The Operating Modes

---

### Multi Mode

# Multi Mode

Multi Mode allows you to select and play Multis.

A Multi allows up to 4 instrument sounds (Programs) to be played from the keyboard at once. A Multi has four Zones, each with its own keyboard range, Program, MIDI channel, and controller assignments. To enter Multi Mode from another Mode, press the Multi Mode button.

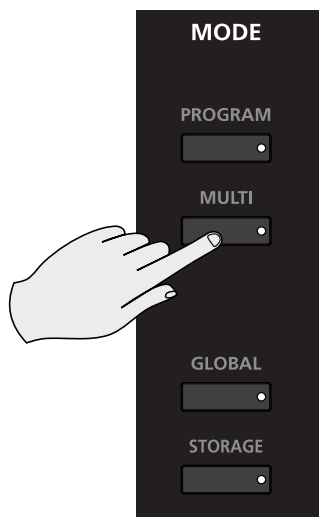

For more detailed information on Multi Mode, see Multi Mode on page 8-1.

# Global Mode



**CAUTION: THIS MODE CONTAINS CERTAIN OPERATIONS THAT CANNOT BE UNDONE.** Read Global Mode on page 10-1.

Global Mode allows you to edit global parameters and MIDI settings, use diagnostic tools, view information, and restore the Forte back to factory default settings. To enter Global Mode from another Mode, press the Global Mode button.



## The Operating Modes

---

### Storage Mode

# Storage Mode

Storage Mode allows you to load or store user-created Programs and Multis with a computer or a USB thumb drive.

To save the existing User Programs/Multis choose the STORE option.

To load a file containing existing User Programs/Multis choose the LOAD option.

Whenever a storage device is being accessed, the “Storage Active” LED will be lit.

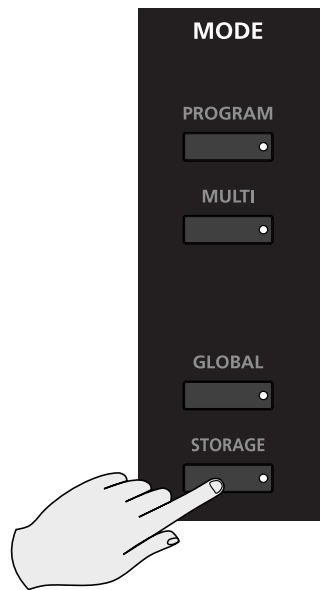

## Functions

In addition to the four primary Modes, there are six Functions. Some Functions are available through dedicated buttons; others are available as Soft Buttons accessed via the buttons under the LCD screen. These Functions are not as complex as the primary Modes and are described below.

### The Split Function

Pressing the Split Soft Button while in either Program or Multi Mode performs the Split Function. The Split Function allows you to split Programs and Multis such that keys in one region of the keyboard produce different sounds than another region.

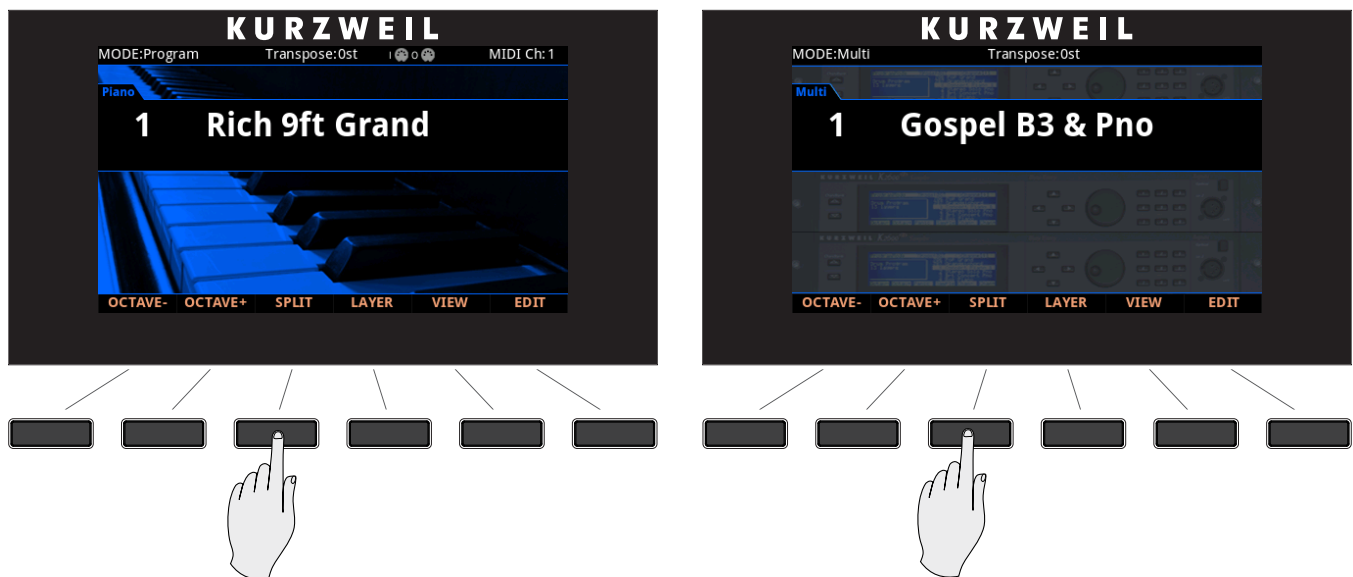

Creating Splits in Program Mode is slightly different from creating Splits in Multi Mode. See The Split Function on page 6-13 (for Splits in Program Mode) and The Split Function on page 8-9 (for Splits in Multi Mode).

### The Layer Function

Pressing the Layer Soft Button while in either Program or Multi Mode performs the Layer Function. The Layer Function allows you to layer Programs and Multis such that more than one sound can be produced by striking one key.

# The Operating Modes

## Functions

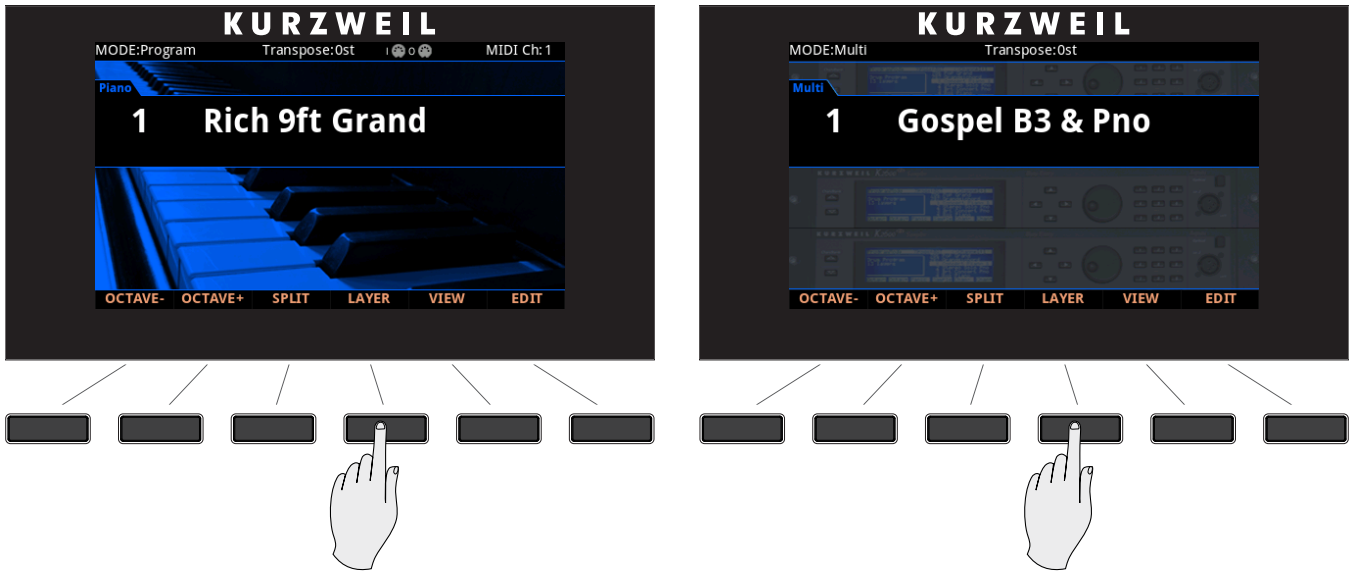

Creating Layers in Program Mode is slightly different from creating Layers in Multi Mode. See The Layer Function on page 6-16 (for Layers in Program Mode) and The Layer Function on page 8-12 (for Layers in Multi Mode).

## Song Demo Function

Pressing the Hybrid & Misc Category keypad buttons simultaneously performs the Song Demo Function.



Use the Song Demo Function to play built-in songs designed to demonstrate the capabilities of the Forte.

While using the Song Demo Function, the top line of the display shows the text “Song Demo”. The main display shows the ID number and name of the selected Song Demo.

Use the Alpha Wheel or Previous/Next buttons to select another demonstration song. The Hybrid & Misc Category keypad LEDs blink when using the Song Demo Function.

Press the Cancel Soft Button to exit the Song Demo Function.

## Program Demo Function

Pressing the Voices & Mallets Category keypad buttons simultaneously performs the Program Demo Function.



In Program Mode, use the Program Demo Function to play a built-in demo song that demonstrates the selected Program. The Voices & Mallets Category keypad button LEDs blink when using the Program Demo Function.

Press the Cancel soft button to exit the Program Demo Function.

## The Operating Modes

### Program Edit Mode

# Program Edit Mode

Program Edit Mode allows you to edit pre-existing Programs. To enter Program Edit Mode press the Edit Soft Button while in Program Mode.

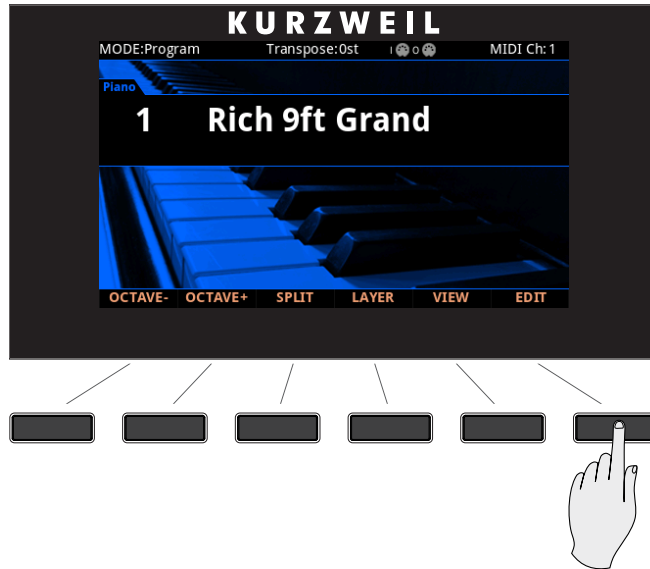

# Multi Edit Mode

Multi Edit Mode allows you to edit pre-existing Multis. To enter Multi Edit Mode press the Edit Soft Button while in Multi Mode.

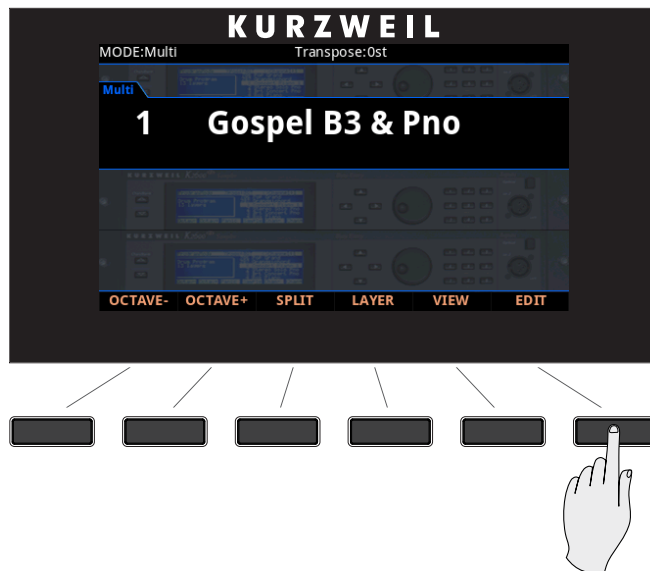

For more detailed information on Multi Edit Mode, see Multi Edit Mode on page 9-1.

# Chapter 6

## Program Mode

This chapter will help familiarize you with the features of Program Mode.

Programs are essentially the different sounds of a MIDI instrument—they are preset instrument sounds equivalent to the “patches,” “presets,” or “voices” that you find on other keyboards.

### About Program Mode

Program Mode is the default Mode of the Forte. It will always boot up in this Mode.

To enter Program Mode from another Mode, press the Program Mode button. While you are in Program Mode, the Program button’s LED is illuminated.

The Forte starts up with Program 1 selected, or the Program that was selected the last time Global mode was exited.

If you enter Program Mode from another Mode, the current Program will be the last selected Program on the current MIDI Channel.

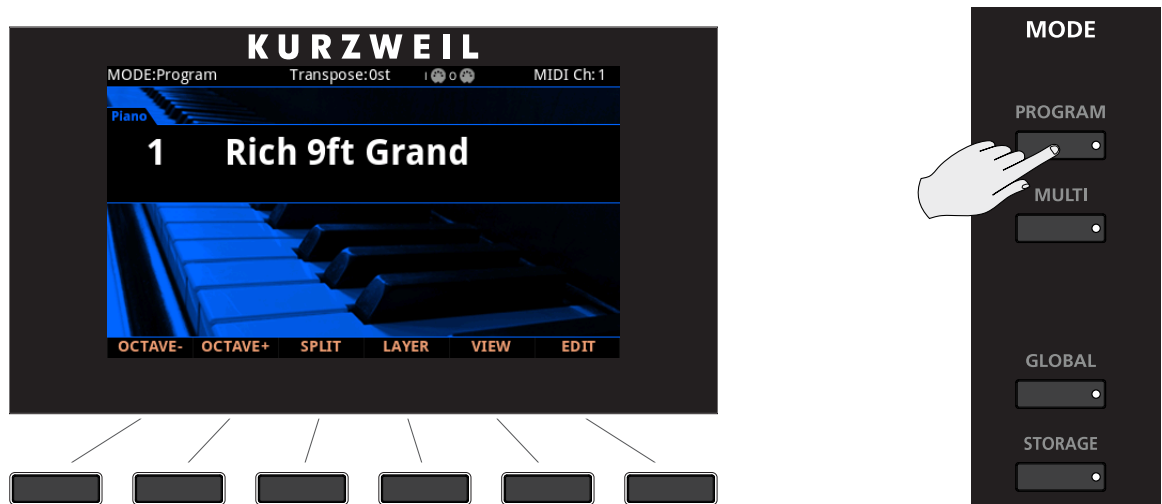

# Selecting Programs

When you are in Program Mode, there are a few ways to select Programs.

- To select a Program in the current Category, use the Alpha Wheel or the Next and Previous buttons.
- To select a Program in a different Category, press the Category button of choice and then use the Alpha Wheel or the Next and Previous buttons.
- To select the default Program from a Category, simply press the relevant Category Button.
- To browse saved user Programs, press the User button, then use the Alpha Wheel or the Next and Previous buttons. Press the User button again to stop viewing only user Programs, or press a Category button or use keypad mode to enter a factory ID number.
- The Alpha Wheel and the Next and Previous buttons allow you to advance through the Programs one at a time. When you reach the end of the Category, advancing further will go to the next Category.
- If a Program is assigned to a Favorite Button, pressing that button will go directly to the assigned Program.
- To select a Program by ID number, press the Keypad Button so that its LED lights. Use the numbers on the Category buttons to enter an ID number, then press the Enter button. In Keypad mode the list of Programs is sorted by ID number only, instead of by Category and ID. Using the Alpha Wheel or Previous/ Next buttons will select the previous or next used Program ID, regardless of category. Press the Keypad Button again to return to Category selection.

## Program Demo

If you want to quickly hear what a Program sounds like, try the Program Demo Function.



In Program Mode only, pressing Voices & Mallets Category buttons simultaneously performs the Program Demo Function. The Program Demo Function plays a demo song for the currently selected Program.

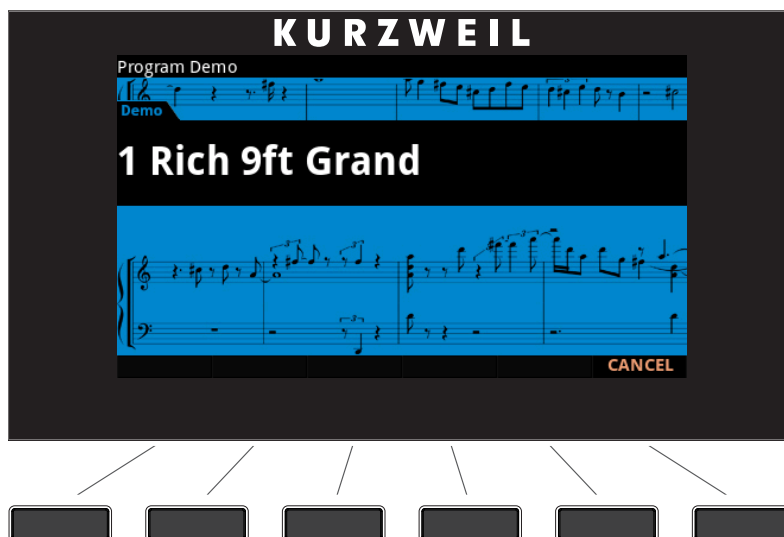

Press the Cancel soft button to exit Program Demo.

If you try to use the Program Demo Function from any other Mode, the display shows the “Please go to Program Mode to hear a Program Demo” message.

## Program Mode

### Selecting Programs

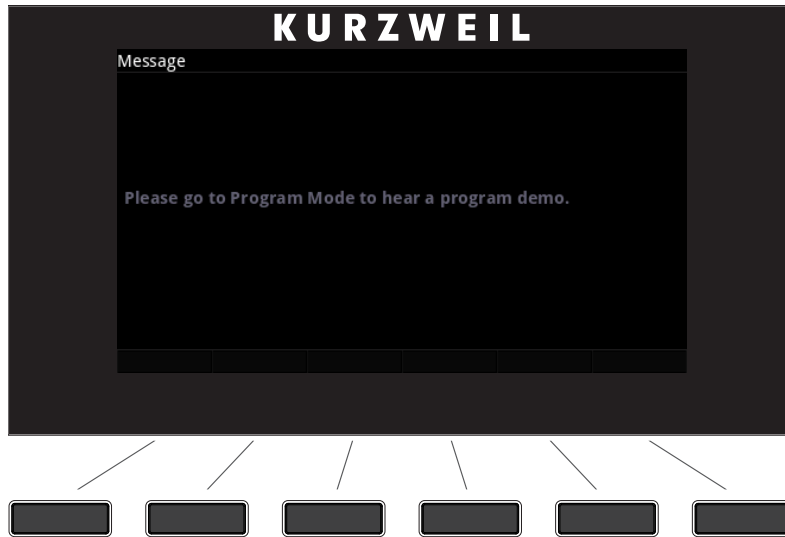

## The Color Display

In Program Mode, the top line of the display shows the current Mode, MIDI transposition, MIDI In/Out activity indicators, and MIDI channel. If Favorites view is selected and the Global Mode User Type parameter has been set to Advanced, the current Favorites Bank number will be shown instead of the current MIDI channel.

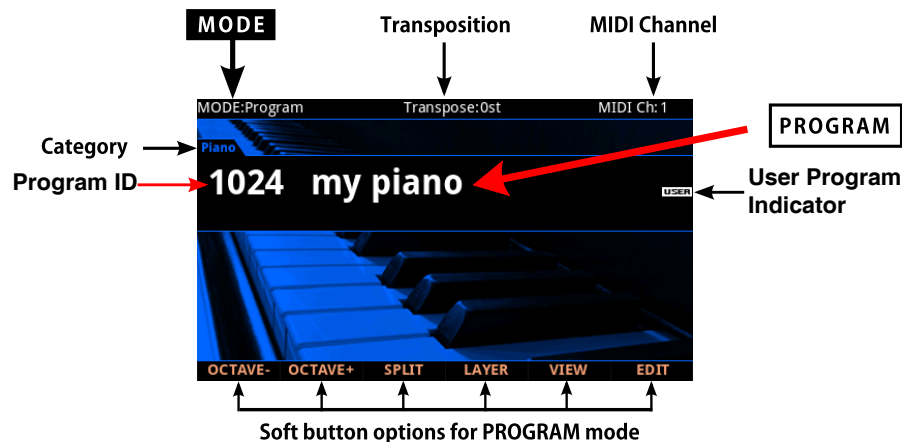

If the currently selected Program is a User Program, the User button will be lit and the "USER" indicator will appear to the right side of the Program ID number and name.



**NOTE :** The display can be changed to an alternate layout by pressing the “VIEW” soft button, or changing the “Display” parameter in Global Mode.

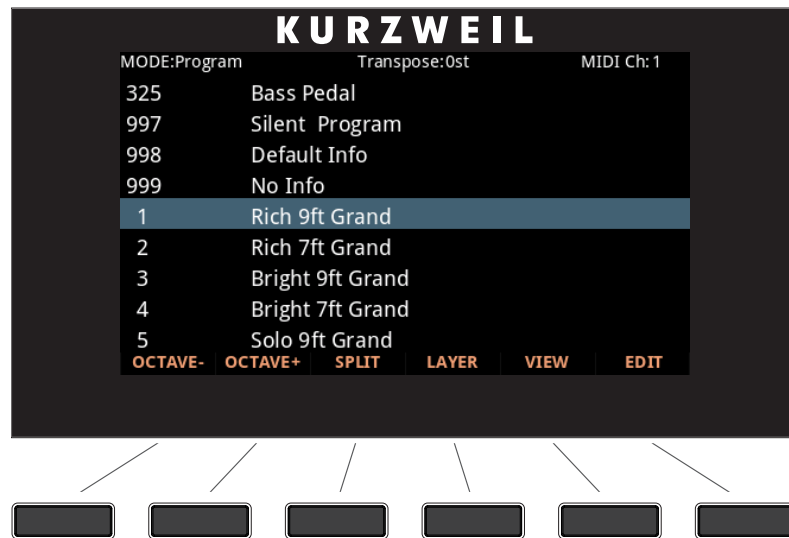

### Pop-Up Messages

Some actions cause the display to show pop-up messages. After a short time the display returns to show the current Program.

### MIDI In/Out Activity Indicators

MIDI In/Out activity indicators are displayed at the top of the screen (shown as 2 MIDI port symbols with “I” for “in” and “O” for “out”). These indicators briefly light up when MIDI has been recently sent to or received by the Forte’s MIDI/USB ports. If the symbol is green, this indicates there has been MIDI activity on that port in the last few seconds. If the symbol is red, this indicates there has been communication with the external software editor on that port in the last few seconds. If the symbol is grey, this indicates there has been no MIDI activity on that port in the last few seconds.

### Alpha Wheel & Previous (-) and Next (+) Value Buttons

Use the Alpha Wheel or the Previous (-) and Next (+) buttons, to the right of the display below the Alpha Wheel, to change the current Program. Turning the Alpha Wheel counter-clockwise or pressing the Previous button will select the previous Program and turning the Alpha Wheel clockwise or pressing the Next button will select the next Program.

## Program Mode

### Selecting Programs

---



If the User button LED is not lit, the Alpha Wheel or the Previous (-) and Next (+) buttons will move through the Program list of each Category, showing both factory and User programs for each Category. If the User button LED is lit, the Alpha Wheel or the Previous (-) and Next (+) buttons will move through the Program list of each Category, showing only User programs for each Category. When the highest or lowest Program is reached, the list will wrap back to the first or last Program, respectively.

## Value Jump Buttons

In Program Mode, the Value Jump double button press selects the first Program of each Category, as well as the Category Default Program of each Category (if a Category Default Program has been set). For more information on choosing a new Category Default Program for each Category, see “Choosing Category Default Programs” on page 6-8. If the User button is selected, Value Jump works the same way.

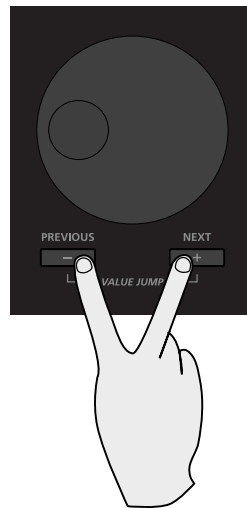

## Category Buttons

The Category buttons allow you to select Programs by instrument type simply by pressing a button. You can select one Category button at a time and the current Category button's LED is lit.

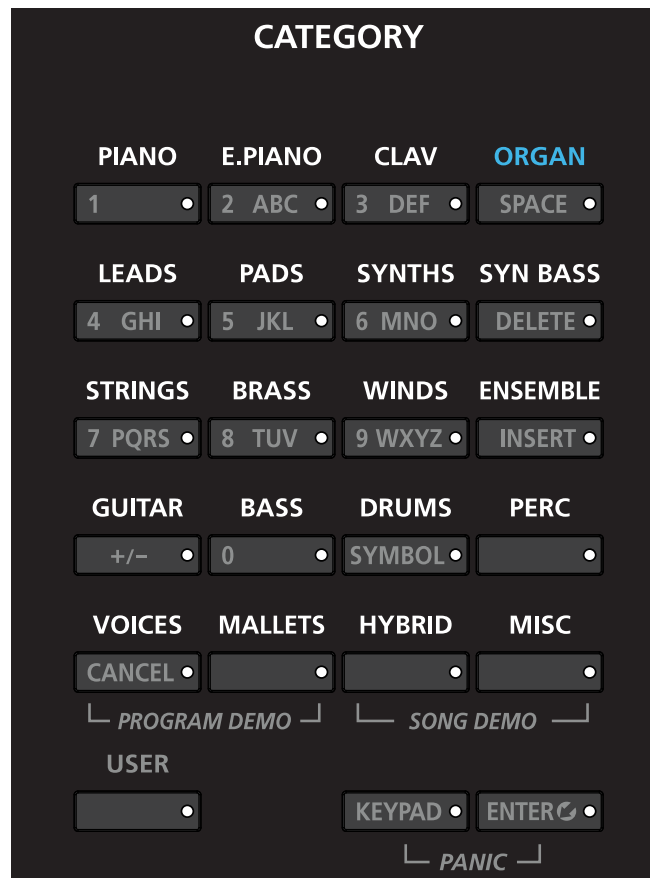

Each Category contains Programs of a single instrument type. (Appendix C on page C-1 has a list of Programs and Categories).

You can also press one of the instrument Category buttons, then turn the Alpha Wheel clockwise or press the Next button to advance to the next Program in the Category. When you reach the end of a Category, the Forte automatically advances to the beginning of the next Category. This will also work in reverse if you turn the Alpha Wheel counter-clockwise or press the Previous button. In this case, when you reach the beginning of a Category, the Forte automatically advances to the end of the previous Category.

### Keypad button

When the Keypad button is pressed and the LED is lit, the Category buttons no longer function in selecting categories. Instead, the secondary function of the Category buttons takes over and the numbers on the category buttons are now in effect.



## Program Mode

---

### Selecting Programs

By having the Keypad button on, you can manually type in the Program ID number followed by the Enter number and the Forte will go to that Program if it exists. If a Program does not exist, the ID will be displayed along with “Not found!”. When the Keypad button and the User button are enabled, User programs are ordered by ID number instead of by category when scrolling through the Program list.

## Choosing Category Default Programs

You can choose a “Category default program” from each Category that will be recalled each time you press that Category’s button. To save a Category default program, first select a Program using any Program select method (Alpha wheel, Previous/Next buttons, Category buttons). A Category button for the current Category will have a lit LED. Next, press and hold the currently lit Category button until the display shows the message “Category default program saved.” The Category default program has now been successfully saved.

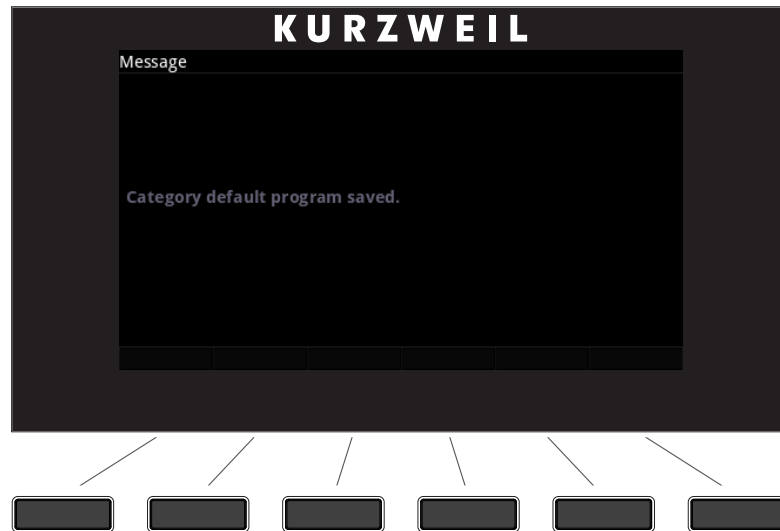

## Choosing Favorites

You can save ten Favorite Programs (or Multis) from any Category to the ten Favorite Buttons beneath the display. Once saved, these favorite Programs can be recalled from any Mode with a single button press. To save the currently selected Program to a Favorite Button, press and hold a Favorite Button until the display shows a message indicating the favorite has been saved.

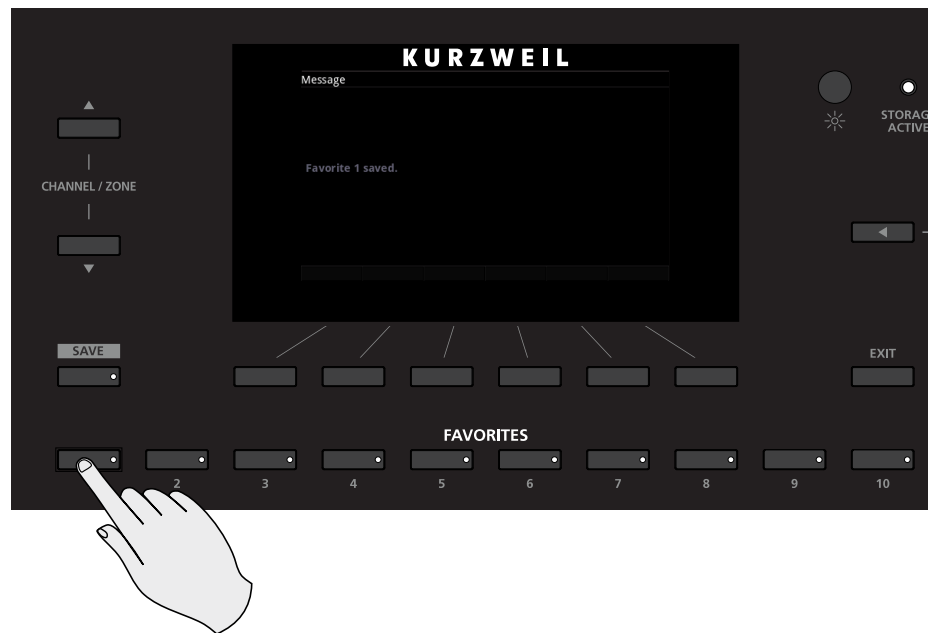

### Favorites View and Favorites Banks

To view the names of Programs and Multis stored as Favorites, press the View soft button until you see the Favorites listed at the bottom of the display, or set the Global Mode “Display” parameter to “Favorites”. If Favorites view is selected and the Global Mode User Type parameter has been set to Advanced, you can use the Channel/Zone buttons to scroll through 16 banks of 10 Favorites, allowing you to save and access 160 Favorites. When Favorites view is selected and the Global Mode User Type parameter has been set to Advanced, the current Favorites Bank number will be shown in the upper right hand corner of the screen instead of the current MIDI channel.

# Transposition

The Transpose buttons can be used to change the tuning of notes played on the Forte keyboard in semitones (ST), also known as half-steps. This is a convenient way to change the key of a song without learning to play it in a different key. The Transpose buttons are located to the left of the keyboard, above the Pitch and Mod Wheels. The Transpose buttons also transpose MIDI notes sent to the USB and MIDI out ports.

Press the Transpose - or + buttons to transpose the Forte keyboard down or up by one semitone. The top line of the display shows the current transposition value.

To transpose up and down by octave intervals (12 ST), press the OCTAVE- and OCTAVE+ soft buttons underneath the display.

Pressing both Transpose - and +, or Octave - and + simultaneously will reset the transposition to 0.

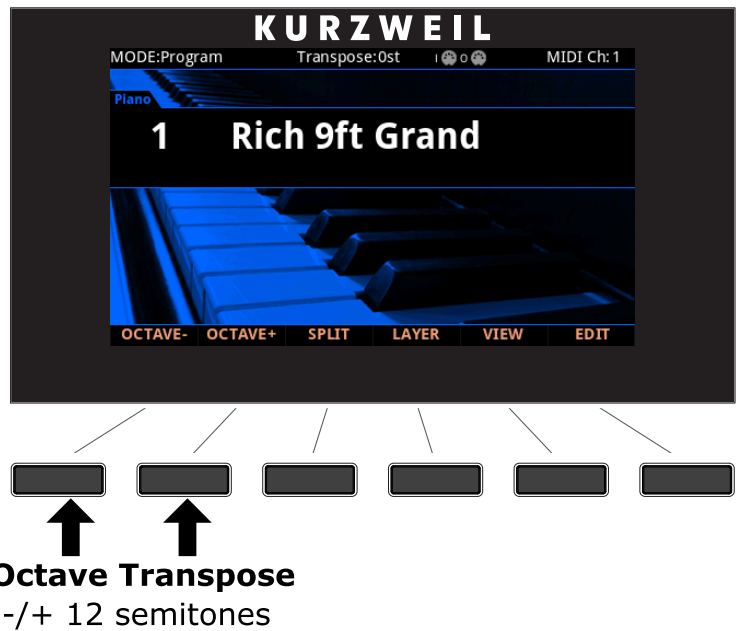
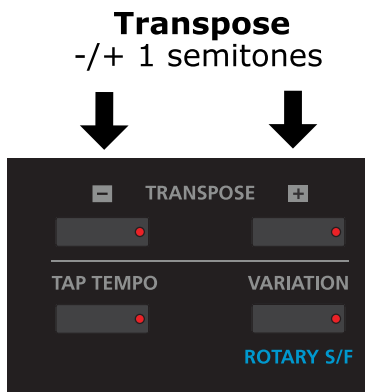

The maximum transposition value possible is +/-36 semitones.

The LEDs of the Transpose buttons indicate whether the current Program (or Multi) is transposed up (Transpose + LED is lit) or transposed down (Transpose - LED is lit). When there is no transposition, neither Transpose button is lit.

## Parameter Assignments

In Program Mode, each Program has factory-set Program and Effect parameters assigned to physical controllers (Sliders, Switch buttons, Mod Wheel, and Pedals). A parameter assignment can modify an instrument sound during a performance to add variation or expression. Moving a controller changes the value of the parameter. Any time you do this, the display shows the Controller name, assigned parameter, and value.

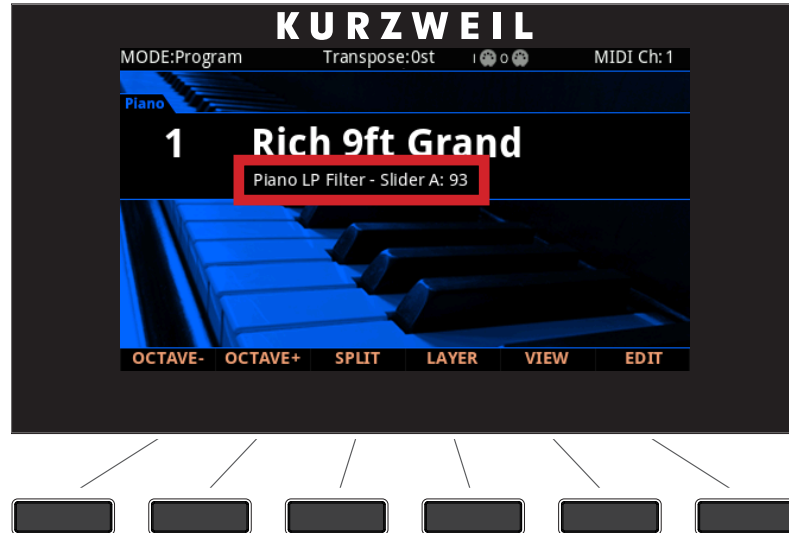

**NOTE :** Parameter assignments may not be visible if the VIEW soft button has been pressed, or if the “Show Controllers” parameter in Global Mode has been set to No.

If you make changes to the current Program using any of the controllers, the Save button’s LED lights to indicate that a change has been made to that Program. For more information on the Save button, see “Save User Programs” on page 6-21



# Program Mode

## Parameter Assignments

### Controller Conventions

Generally the factory Programs have the following controllers assigned.

#### Forte Controller Conventions

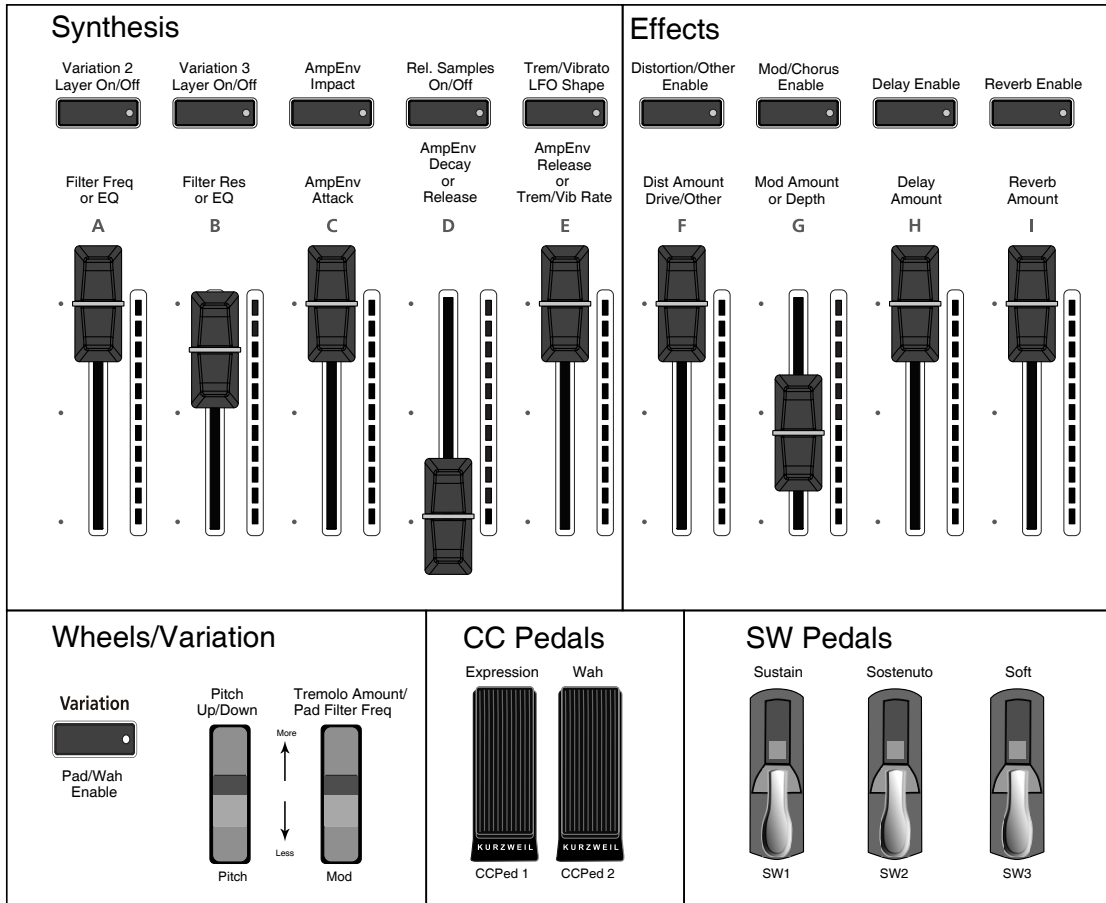

## The Split Function

Pressing the Split soft button while in Program Mode will perform the Split Function. The Split Function allows you to split Programs such that keys in one region of the keyboard produce different sounds than another region.

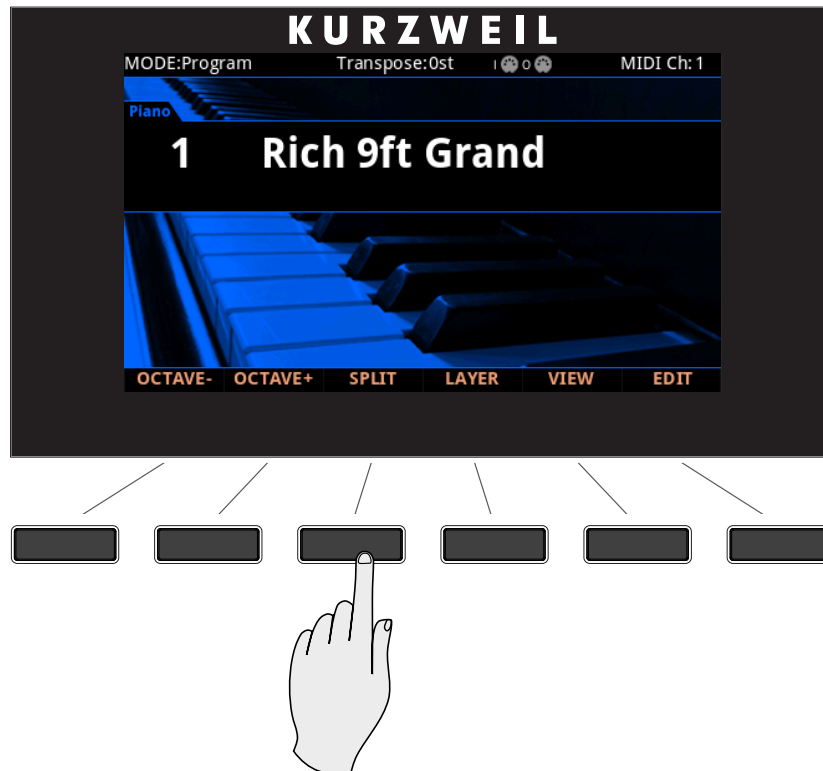

When you create a Split in Program Mode, you are in fact creating a Multi with two active Zones (see “Multi Mode” on page 8-1, for more information on Multis). As previously described, Multis are configurations of four Zones, each of which may have its own Program and controller assignments.

The Split Function is convenient, as it automatically configures a Multi to function as a Split by setting Zone key ranges and Programs. You can simply hit the Split button, and the Forte automatically creates a Multi with two active Zones. The Program you were using in Program Mode is used in the right hand of the Split as the Program for Zone 1. After this you can choose a “Split Program” that will be used in the left hand of the Split as the Program for Zone 2.

Once you have saved your Split as a Multi, you can continue to add Split or Layer Zones to the Multi until you reach the maximum of four active Zones. The Forte will display a message if you have already reached the maximum of four active Zones (“Multi Mode” on page 8-1).

## Program Mode

### The Split Function

---

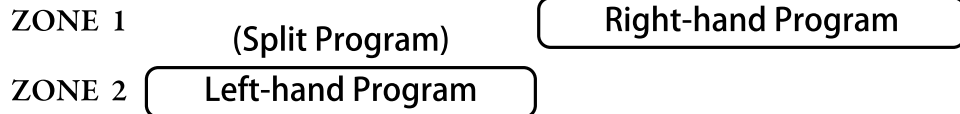

There are four parameters (described below) that determine the behavior of the Split. Use the cursor buttons to access each of the Split parameters for each active Zone.

#### Program

The Program parameter for Zone 2 determines the Program for the left-hand side of the Split, also known as the “Split Program”. This parameter is selected by default when performing the Split function, and the default Split Program (245 Finger Bass) will be selected. Choose a Split Program using the Category buttons, the Alpha Wheel, the Previous/Next buttons, or enable the Keypad button and type an ID number followed by the Enter button.

#### Volume

To change the volume of a Zone, use the cursor buttons to select the Volume parameter for one of the Zones. To set a volume, use the Alpha Wheel, the Previous/Next buttons, or use the keypad function of the Category buttons to type a volume (0-127) followed by the Enter button.

#### Key Range

You can adjust the boundary between the left and right hand Programs on the keyboard by adjusting the Key Range low and Key Range high parameters for each Zone. The keyboard display for each Zone shows a visual indication of the Key Range by dimming keys that are outside of the Key Range.

To change the Key Range of a Zone, use the cursor buttons to select the Key Range low or Key Range high parameters for one of the Zones. Key Range low and Key Range high are the left and right parameters, respectively, below the Key Range label. With one of these parameters selected, set the Key Range by using the Alpha Wheel, the Previous/Next buttons, or use the keypad function of the Category buttons to type a key number (0-127) followed by the Enter button. With Key Range low or Key Range high selected, the value can also be changed by holding the Enter button, then pressing the desired key.

## **Pan**

To change the panning of a Zone (left/right stereo placement), use the cursor buttons to select the Pan parameter for one of the Zones. To set a Pan value, use the Alpha Wheel, the Previous/Next buttons, or use the keypad function of the Category buttons to type a pan value (0-127) followed by the Enter button. A value of 0 is full left, 64 is center, and 127 is full right. Other values will move the stereo placement in between these positions. A value of “None” will use the last pan value used by the Zone’s MIDI channel. A value of “None” can be entered by scrolling below 0, or by using the keypad function of the Category buttons to type negative 1 by pressing the +/- button and then the 1 button, followed by the Enter button.

## **Saving a Split**

After setting the Split parameters, the Split can be saved as a Multi so that it can easily be recalled in Multi Mode. Press the Save button to the left of the display to begin the saving process. A Multi name is automatically created using half of the right hand Program name and half of the default left hand program name. This name can be edited during the saving process.

See “Save User Multis” on page 8-15 in the Multi Mode Chapter for details on saving. Once you have saved your Split as a Multi, you can continue to add Split or Layer Zones to the Multi until you reach the maximum of four active Zones.

See The Split Function on page 8-9 and “The Layer Function” on page 8-12 in the Multi Mode Chapter. Also, once you have saved your Split as a Multi, you can use Multi Edit Mode to edit controller assignments (like effects controls and sustain pedal per Zone), transposition per Zone, and other Multi parameters. (See “Multi Edit Mode” on page 9-1 for details.)

## Program Mode

### The Layer Function

# The Layer Function

The Layer Function is convenient, as it automatically configures a Multi to function as a Layer by setting Zone key ranges and Programs. The Layer Function allows you to layer Programs and Multis such that more than one sound can be produced by striking one key.

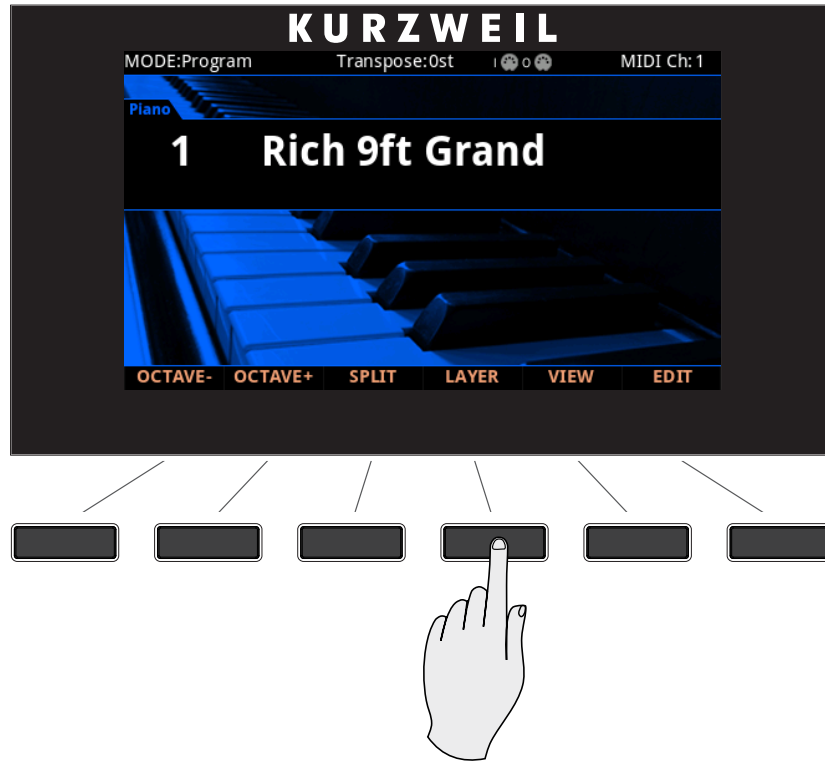

When you create a Layer in Program Mode, you are in fact creating a Multi with two active Zones (see “Multi Edit Mode” on page 9-1, for more information on Multis). As previously described, Multis are configurations of four Zones, each of which may have its own Program and controller assignments.

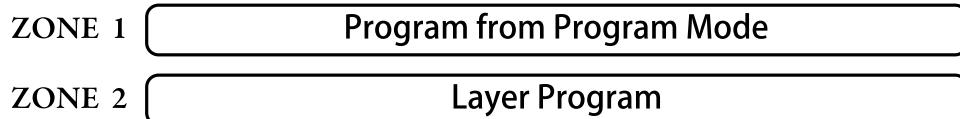

The Layer Function is convenient, as you do not need to use Multi Edit Mode to configure Zone key ranges, Programs, and volumes. You can simply hit the Layer button, and the Forte automatically creates a Multi with two active Zones. The Program you were using in Program Mode is used as the Program for Zone 1. It then allocates “152 Add a Pad 2” as the default program for Zone 2. Both of these Programs can be changed if needed.

Once you have saved your Layer as a Multi, you can continue to add Layer or Split Zones in Multi Mode until you reach the maximum of four active Zones. The Forte will display a message when you have reached the maximum of four active Zones. (See “Multi Mode” on page 8-1, for more information on Multis.)

There are four parameters (described below) that determine the behavior of the Layer. Use the cursor buttons to access each of the Layer parameters for each active Zone.

### **Program**

The Program parameter for Zone 2 determines the “Layer Program” that will be layered on top of the Program you were using in Program Mode. This parameter is selected by default when performing the Layer function, and the default Layer Program (152 Add a Pad 2) will be selected. Choose a Layer Program using the Category buttons, the Alpha Wheel, the Previous/Next buttons, or enable the Keypad button and type an ID number followed by the Enter button.

### **Volume**

To change the volume of a Zone, use the cursor buttons to select the Volume parameter for one of the Zones. To set a volume, use the Alpha Wheel, the Previous/Next buttons, or use the keypad function of the Category buttons to type a volume (0-127) followed by the Enter button.

### **Key Range**

By default the Layer Program covers the whole range of the keyboard, but if desired you can adjust the layer Key Range to make the Layer Program cover only a certain range of the keyboard. You can adjust the boundary of each Program on the keyboard by adjusting the Key Range low and Key Range high parameters for each Zone. The keyboard display for each Zone shows a visual indication of the Key Range by dimming keys that are outside of the Key Range.

To change the Key Range of a Zone, use the cursor buttons to select the Key Range low or Key Range high parameters for one of the Zones. Key Range low and Key Range high are the left and right parameters, respectively, below the Key Range label. With one of these parameters selected, set the Key Range by using the Alpha Wheel, the Previous/Next buttons, or use the keypad function of the Category buttons to type a key number (0-127) followed by the Enter button. With Key Range low or Key Range high selected, the value can also be changed by holding the Enter button, then pressing the desired key.

## Program Mode

---

### The Layer Function

#### **Pan**

To change the panning of a Zone (left/right stereo placement), use the cursor buttons to select the Pan parameter for one of the Zones. To set a Pan value, use the Alpha Wheel, the Previous/Next buttons, or use the keypad function of the Category buttons to type a pan value (0-127) followed by the Enter button. A value of 0 is full left, 64 is center, and 127 is full right. Other values will move the stereo placement in between these positions. A value of “None” will use the last pan value used by the Zone’s MIDI channel. A value of “None” can be entered by scrolling below 0, or by using the keypad function of the Category buttons to type negative 1 by pressing the +/- button and then the 1 button, followed by the Enter button.

### **Saving a Layer**

After setting the Layer parameters, the Layer can be saved as a Multi so that it can easily be recalled in Multi Mode. Press the Save button to the left of the display to begin the saving process. See “Save User Multis” on page 8-15 in the Multi Mode Chapter for details on saving. A Multi name is automatically created using half of the Zone 1 Program name and half of the default layer program name. This name can be edited during the saving process.

Once you have saved your Layer as a Multi, you can continue to add Split or Layer Zones to the Multi until you reach the maximum of four active Zones. See The Split Function on page 8-9 and The Layer Function on page 8-12 in the Multi Mode Chapter. Also, once you have saved your Layer as a Multi, you can use Multi Edit Mode to edit controller assignments (like effects controls and sustain pedal per Zone), transposition per Zone, and other Multi parameters. (See “Multi Edit Mode” on page 9-1 for details.)

## Changing the MIDI Transmit Channel

The current MIDI Transmit channel is shown on the right side of the top line of the display. Press the Channel / Zone Up or Down buttons to change the MIDI Transmit channel. A different Program can be selected for each MIDI Channel. All channels can be triggered simultaneously from an external MIDI sequencer or computer. The Aux FX Chains of the Program on the currently selected MIDI Channel are used for Programs on all Channels.



Pressing both Channel / Zone Up and Down buttons at the same time will reset the current MIDI Transmit channel to 1.

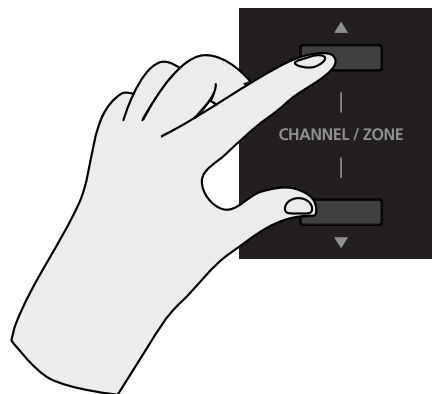

## Program Mode

### Panic

# Panic

Pressing the Keypad & Enter buttons simultaneously deactivates all sounding notes and resets controller values by sending an “All Notes Off” message and a “Reset All Controllers” message on all 16 MIDI channels.

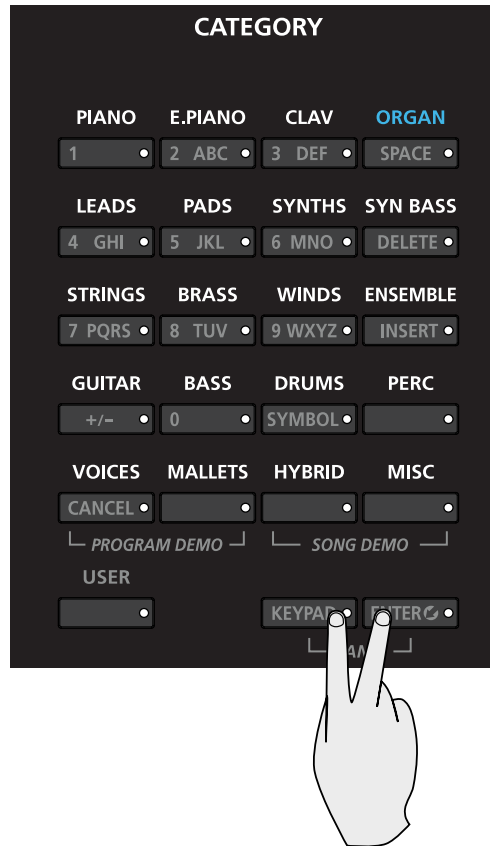

## Save User Programs

If you make changes to the current Program using any of the controllers, the Save button's LED lights to indicate that a change has been made to that Program.



To save the changes you've made, press the Save button once to display the Save Dialog.

The display shows the first available ID number and the current Program name. You can save Programs with ID numbers from 1024 to 2047. If you are saving a Program that has not been previously edited, the next available unused ID number will be selected. If you are saving a previously edited User Program, the ID number that the Program was last saved with will be selected. Press the Value Jump double button press (Previous + Next) to toggle between selecting the ID number that the Program was last saved with and the next available unused ID number. When viewing the Save Dialog, you can quickly save the Program to the displayed ID number by pressing the Save button again.

## Changing ID Numbers

To change the ID number, turn the Alpha Wheel or use the Previous/Next buttons to select the new ID number. The label underneath indicates if it is an "Unused ID". You can also use the keypad function of the Category buttons to type an ID number, followed by pressing the Enter button.

## Program Mode

### Save User Programs

---

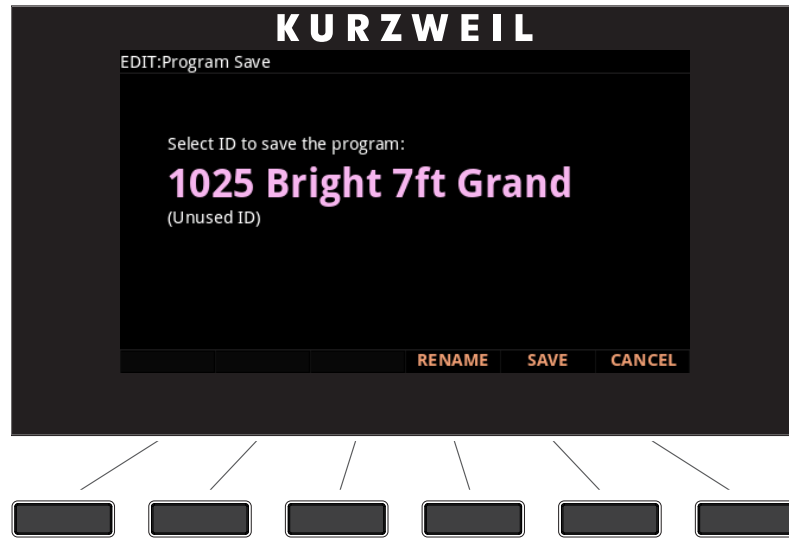

If you select an ID currently in use, the display will notify you that by saving you will “replace” the Program currently in that location. The Program name and ID is indicated.

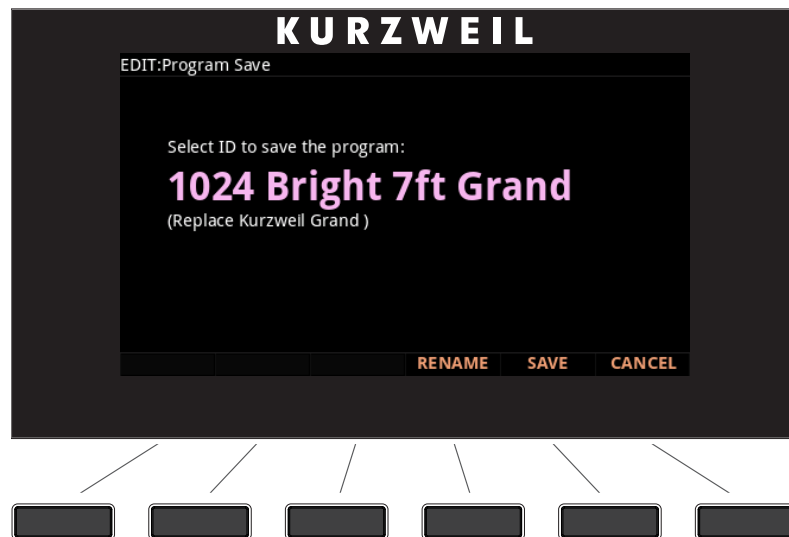

Confirm overwriting of the existing Program by pressing Save, or choose a different ID.

## Naming a User Program

To rename the Program, first press the RENAME soft button. You should see the following in the display:

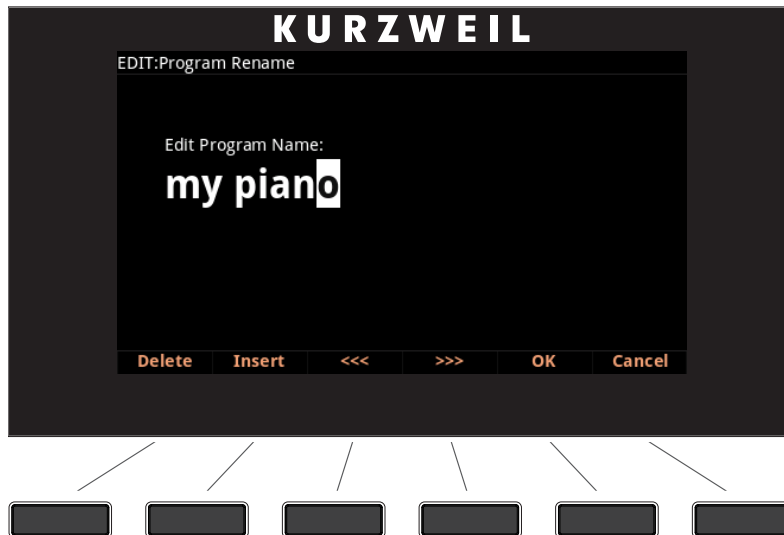

The display shows the current Program name. Program names can total 16 characters in length. Use the letters and numbers printed on the Category buttons to enter the new Program name. Rotating the Alpha Wheel or using the Value buttons can also change the Program name. The keypad button will be turned on automatically.

Use the Left/Right cursor buttons or <<< >>> soft buttons to move the cursor. Press the +/- button to switch between upper and lower case characters (all characters will be upper case until you press the +/- button again).

Use the Space button to change the current character to a space, the Insert button to insert a blank space (the selected character and all characters to the right will move one space to the right), and the Delete button to delete the current character (all the characters to the right will move one space to the left).

## Program Mode

### Save User Programs

## Saving a User Program

Press the Save button or Save soft button to complete the saving process, or press the Cancel soft button to exit without saving. After successfully saving, the Program will be selected in Program Mode. To find the Program again later, press the User button and scroll to the Program ID. You can also find the program by pressing the appropriate Category button and scrolling past the factory programs. Lastly, you can press the Keypad button so that its LED is lit, type the Program ID number, then press the Enter button.

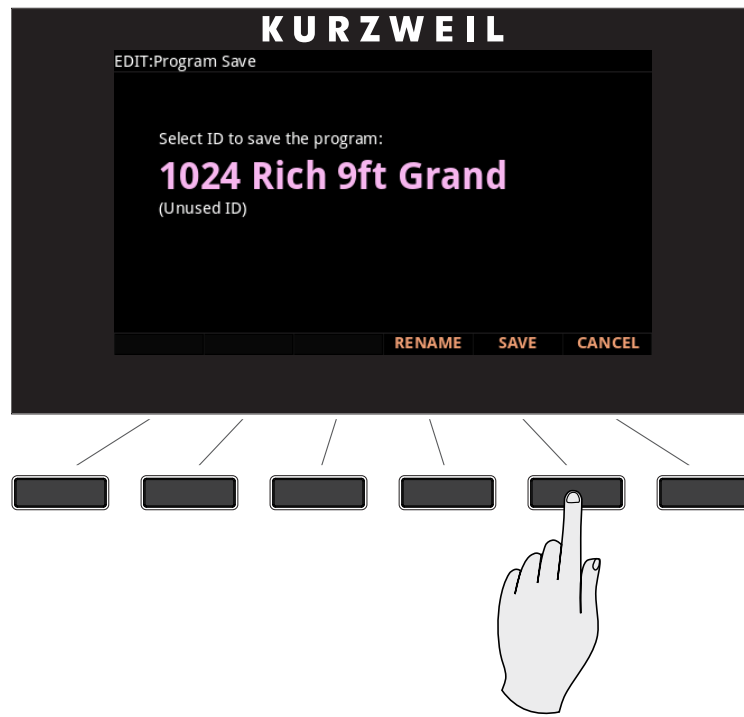

# Chapter 7

## Program Edit Mode

This chapter will help familiarize you with the features of Program Edit Mode.

### About Program Edit Mode



**NOTE :** Before you read this chapter, be sure to read Program Mode on page 6-1 for a full description of Programs.

Program Edit Mode allows you to edit and customize Programs. It gives you access to a Program's parameter controller assignments, effects, and common settings.

Any Program can be edited in Program Edit Mode and saved to one of the 1024 User locations.



## Program Edit Mode

### Selecting Parameters

To enter Program Edit Mode, first press the Program Mode button to enter Program Mode, then press the EDIT soft button.

Once you are in Program Edit Mode, press the soft buttons at the bottom of the screen to navigate to each of the Program Edit Mode pages. See the following sections for details on navigating and changing parameters.

All parameters apply only to the currently selected Program.

## Selecting Parameters

### The Display

In Program Edit Mode, the top line of the display shows the current Mode and Page. Use the cursor buttons to navigate to different rows and columns.

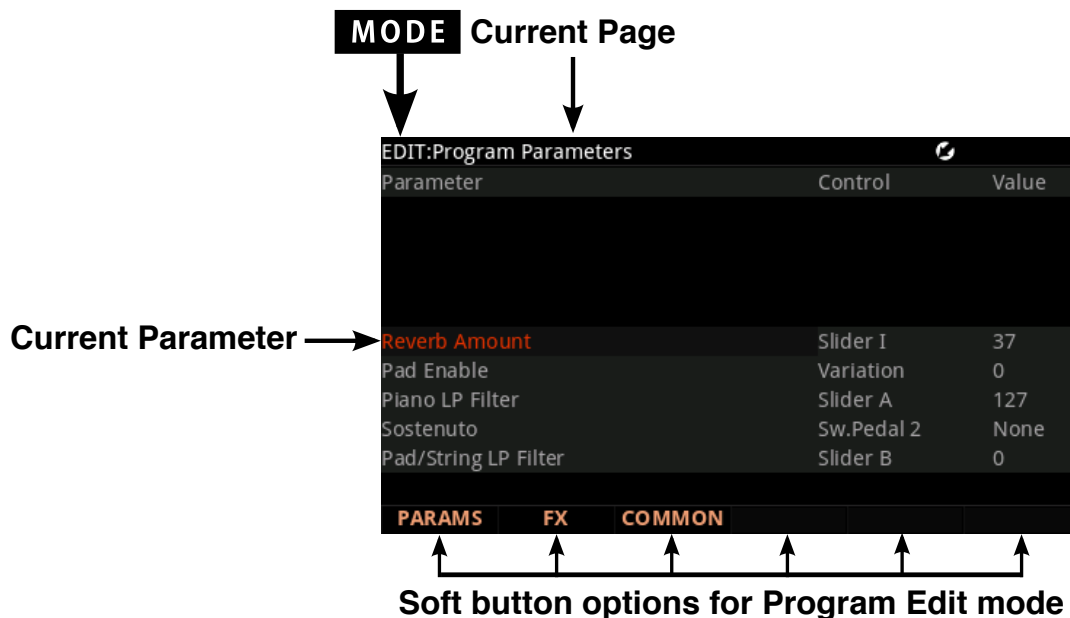

### Alpha Wheel & Previous (-) and Next (+) Value Buttons

Use the Alpha Wheel or the Value buttons to the right of the display below the Alpha Wheel, to change the selected parameter value. Turning the Alpha Wheel counter-clockwise or pressing the Previous button will select the previous value and turning the Alpha Wheel clockwise or pressing the Next button will select the next value.

## Assign

Assign is the secondary function of the Enter button. You can use the Assign function to quickly select parameters or set values for parameters by holding the Enter button while moving Forte controllers (Sliders, Switch buttons, Keys, Mod Wheel, and Pedals).



Parameters that can use the Assign function are indicated by showing the Assign symbol in the top right corner of the display when selected.

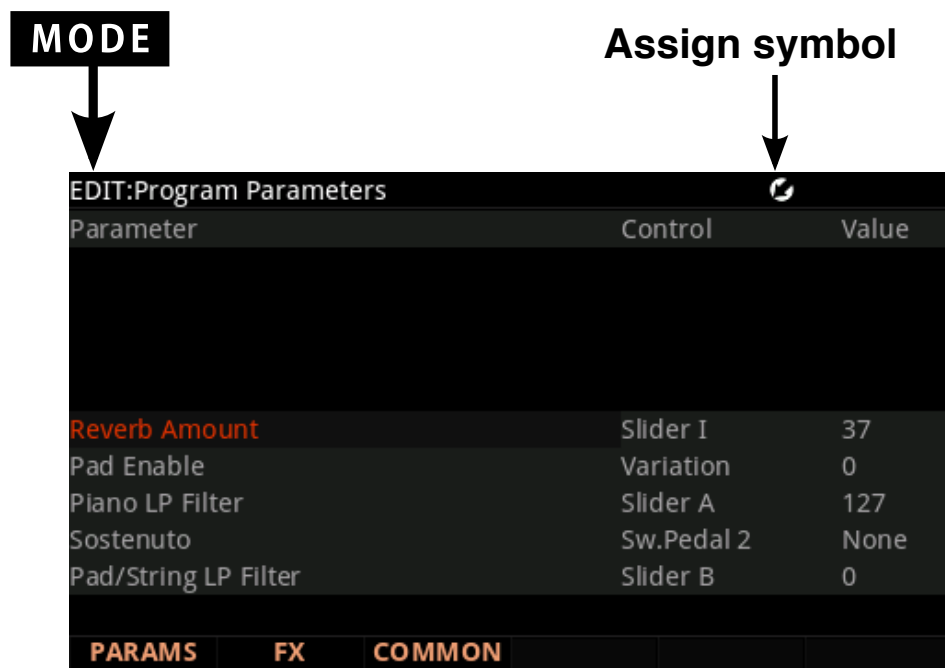

Pressing a key, switch, or moving a controller while holding down the Enter button will perform Assign in the following cases.

### Enter + Controller

On the Program Edit Mode Parameters page, select any parameter in the Parameter column, hold the Enter button and move a controller (a Slider, Switch button, Mod Wheel or Pedal). Doing this will jump to selecting the parameter that is assigned to the moved controller (if a parameter is assigned to that controller).

On the Program Edit Mode Parameters page, select any parameter in the Control column, hold the Enter button and move a controller (a Slider, Switch button, Mod Wheel or Pedal). Doing this will assign the selected parameter to be controlled by the moved controller.

# Program Pages

The parameters for each page in Program Edit Mode are explained in detail below.

## PARAMS Page



Parameter	Range Of Values	Default Value
Parameter	Program / Effect Chain dependent	-
Control	Physical controller or MIDI CC	None
Value	None, 0 to 127	None

Press the PARAMS soft button to display the Parameters page (see above.)

The Parameters page allows you to access all of the controllable parameters for the current program. The parameters page will also display any available VAST synthesis parameters for the current program and parameters for the current program's insert and auxiliary 1&2 effects (if effects are in use.) All available parameters are listed. For each parameter you can set a MIDI value as well as a control source.

The left column lists the available parameters, the center column shows the control source (either a physical controller or MIDI CC number) which that parameter is controlled by, and the right column shows the MIDI value for each parameter.

### Parameter

Use the cursor buttons to select a parameter in the left column, and use the Alpha Wheel, Value buttons, or cursor up/down buttons to scroll through parameters in that column. Effect Chain parameters are named with prefixes based on their effect type, either “INS” for parameters from Insert effects, or “AUX1/AUX2” for parameters from Aux effects. Effect Chain parameters are also shown with different background colors to help visually separate Insert and Aux parameters.

The parameter column will also display any available VAST synthesis parameters for the current program and parameters for the current program’s insert and auxiliary 1 and 2 effects (if effects are in use.) All available parameters are listed.

### Control

Use the Control (middle) column to set one of the Forte’s physical controllers as a control source for a parameter. Use the Alpha Wheel or the Value buttons to choose one of the Forte’s physical controllers as a control source, or choose a value of None if you don’t want to use a physical controller for this parameter. You can also choose a value of None by entering -1 with the keypad function of the Category buttons followed by the Enter button.

To choose an external MIDI CC number as a control source, you can enter the number of the controller with the keypad function of the Category buttons followed by the Enter button, or using the Alpha Wheel or the Value buttons. Also, the Forte’s physical controllers each use one of the available MIDI CC numbers, so you must choose one of the other available CC numbers when using an external MIDI control source or else the parameter will also be controlled by a Forte physical controller.

This list shows the MIDI CC numbers associated with each controller. The Forte’s physical controllers are highlighted in bold type. This list can be helpful when changing the Control for a parameter. For example, to set a parameter to be controlled by the Zone 1 Switch, you can quickly select it by entering 80 for the control, followed by pressing the Enter button.

PARAMETER CONTROLS		
None	<b>Slider E (MIDI 24)</b>	<b>Zone 1 Switch (MIDI 80)</b>
MIDI 0	<b>Slider F (MIDI 25)</b>	<b>Zone 2 Switch (MIDI 81)</b>
<b>Mod Wheel (MIDI 1)</b>	<b>Slider G (MIDI 26)</b>	<b>Zone 3 Switch (MIDI 82)</b>
MIDI 2 to MIDI 3	<b>Slider H (MIDI 27)</b>	<b>Zone 4 Switch (MIDI 83)</b>
<b>CC Pedal 2 (MIDI 4)</b>	<b>Slider I (MIDI 28)</b>	MIDI 84
MIDI 5 to MIDI 10	<b>Variation (MIDI 29)</b>	<b>Switch 1 (MIDI 85)</b>
<b>CC Pedal 1 (MIDI 11)</b>	MIDI 30 to MIDI 63	<b>Switch 2 (MIDI 86)</b>
<b>Slider A (MIDI 12)</b>	<b>Sw. Pedal 1 (MIDI 64)</b>	<b>Switch 3 (MIDI 87)</b>
<b>Slider B (MIDI 13)</b>	MIDI 65	MIDI 88
MIDI 14 to MIDI 21	<b>Sw. Pedal 2 (MIDI 66)</b>	<b>Switch 4 (MIDI 89)</b>
<b>Slider C (MIDI 22)</b>	<b>Sw. Pedal 3 (MIDI 67)</b>	<b>Switch 5 (MIDI 90)</b>
<b>Slider D (MIDI 23)</b>	MIDI 68 to MIDI 79	MIDI 91 to MIDI 127

## Program Edit Mode

---

### Program Pages

#### Important note about selecting a Control source

When you change the control source for a parameter, the new control source immediately sets its current value for the MIDI value of the current parameter. If the MIDI value of the parameter was set to None before changing the control source, changing the control source will set a new MIDI value, but the Value column for the parameter will still display None (see Important note about values of “None”). This can be troublesome if for example you were to change the Control Source for the Expression parameter, you may accidentally set the MIDI Value to 0, but wouldn’t know it because None would still be displayed. Also, if you set a MIDI Value to None by scrolling below 0, the MIDI value will be 0 until you change the value with the assigned controller (though None will still be displayed). If you edit the parameters of a program and suddenly can’t produce any sound from the program, this may be the cause. In this case, either set the Value for Expression to something other than None, or use the Control Source that you set for Expression to increase the Value.

#### **Value**

To change the value of a parameter, use the cursor button to highlight the right column. In the value column, use the Alpha Wheel or the Value buttons to enter a MIDI value from 0-127, or a value of None by scrolling below 0. You can also use the keypad function of the Category buttons followed by the Enter button to enter a MIDI value. If you set a MIDI Value to None by scrolling below 0, the MIDI value will be 0 until you change the value with an assigned controller (though None will still be displayed). A value of None can also be selected by using the keypad to type -1, followed by the Enter button.

#### Important note about values of “None”

For factory programs, standard parameters like Expression (program volume), Sustain, and Sostenuto are always set to **None** by default. If you change one of these values, either on the Parameters page in the Program Editor, or with a physical controller from Program Mode (or the Program Editor,) **the same value will be used for any other program you select**, if you select another program that uses a value of **None** for the same parameter. **These values remain set even if you don’t save the program.**

This can be useful, for example, when using an expression pedal to control program volume.

By default, all factory programs have their Expression parameter set to a value of **None**, and Expression (program volume) by default can be controlled by an expression pedal plugged into the CC 1 Pedal jack. With an expression pedal plugged into the CC 1 Pedal jack, you can control the volume of any factory program, but when you select another factory program, it will have the same volume that you set with the expression pedal in the last program. This way, the volume of your programs will stay consistent, and can always be changed by the expression pedal. If you want a program to have a default volume, you must set a Value other than **None** for the Expression parameter.

For all parameters with a Value of None, any values set with a physical control will not be saved when saving the program. You must set the Value column for that parameter to something other than None in order to set and save a value. These values will remain set until changed with a controller, or until a program is loaded on the current MIDI channel that does not have a value of None for these parameters.

## FX Page

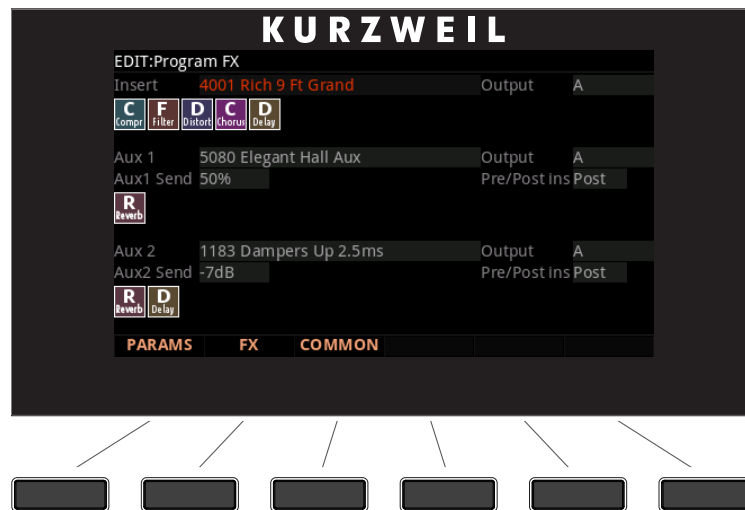

Press the FX soft button to call up the FX page (Effects page). Use this page to apply audio effects to a program. You can choose an effects chain for insert effects and an effects chain for auxiliary effects 1 and 2.

The Forte's chains contain a variety of effects. Each chain displays icons representing the type of effects contained in the chain, as well as the order of effects in the chain (signal flows from left to right). The Forte's chains include different types of reverb, chorus, delay, flanger, phaser, tremolo, panner, leslie, distortion, EQ, compression, filter, envelope following filter, frequency stimulator, ring modulator, frequency offset, pitch LFO, and stereoizer.

Parameter	Range Of Values	Default Value
Insert	Effect list (See Appendix F)	0 None
Aux 1	Effect list (See Appendix F)	0 None
Aux 1 Send	0 to 100%	0%
Aux 2	Effect list (See Appendix F)	0 None
Aux 2 Send	0 to 100%	0%
Aux 2 Send (Piano Programs)	Off, -95dB to 24dB	Off
Output	A, B	A
Pre/Post Ins	Post, Pre	Pre

## Program Edit Mode

---

### Program Pages

#### **Insert**

Choose an effects Chain that will be applied to the current program. If you only need to use one Chain at a time on one MIDI channel, Insert effects may be all you need. If you plan to use multiple programs on different MIDI channels, it is best to use both Insert and Aux effects (see Aux below). Aux effects have the advantage of being available to all programs on each MIDI channel at the same time.

By default, when scrolling through the list of effects Chains for the Insert effect, only Chains with IDs from 4000-5000 will be shown. These Chains are used by the Forte factory programs, and each one will automatically apply controller assignments for effects parameters on the Parameters page. Controller assignments for each of these Chains conform to the Controller assignments shown in the Forte Controller Conventions chart on page 6-12. To access Chains outside of this range, enter an ID number using the keypad function of the Category buttons. For more details on Chain selection, see the parameter User Type on page 10-10 in the Global Mode Chapter.

#### **Aux 1, Aux 2**

Choose an effects Chain for each of the two auxiliary audio buses. An aux bus is an audio channel with a shared effects Chain that can be used by programs on any of the 16 MIDI channels. The aux effect is useful when you want to use the same type of effect for multiple channels (typically used for Reverb or Delay). You apply an aux effect to the program on a MIDI channel by “sending” the audio from that channel to an aux bus.

Every channel is connected to the aux buses, but the aux buses don't receive the signal until you turn up the aux “send” level for that channel, which controls a channel's input level to the aux bus. On each MIDI channel you can control the aux send level for that channel's program, in turn controlling how loudly you can hear the aux effect applied to that channel's program. The aux send level is set by the Aux 1 and Aux 2 Send parameters on the FX page. Many Chains also have an additional Aux send, Wet/Dry, or Amount parameter that will appear on the Parameters page. For Reverb and Delay Chains, send parameters are often assigned by default to Slider I or Slider H respectively.

By default, when scrolling through the list of effects Chains for the Aux effects, only Chains with IDs from 5000-6000 will be shown. These Chains are used by the Forte factory programs, and each one will automatically apply controller assignments for effects parameters on the Parameters page. Controller assignments for each of these Chains conform to the Controller assignments shown in the Forte Controller Conventions chart on page 6-13. To access Chains outside of this range, enter an ID number using the keypad function of the Category buttons. For more details on Chain selection, see the parameter User Type on page 10-10 in the Global Mode Chapter.

## **Output**

The Output parameter specifies the rear panel analog output pair to which the selected aux bus is routed. Setting the Output to A routes the signal of the selected bus to output pair A. Setting the Output to B routes the signal of the selected bus to output pair B. This is useful if you want to control the processed Aux signal with an external mixer or process the signal with additional external effects.

## **Auxiliary Send Parameters**

The Auxiliary Send parameters determine the level of the program signal sent to the auxiliary effects chain.

### **Aux Send**

The Aux 1 send works as a dry/wet mix, so that as you turn up the Aux 1 send, the program's unprocessed signal is turned down. With an Aux 1 send set to 50% you hear an equal amount of processed and unprocessed signal (called wet and dry, respectively.) With an Aux send set to 100% you hear only the processed (wet) signal and none of the original unprocessed (dry) signal.

For most programs, the Aux 2 send works the same way as the Aux 1 send, and send level is set in percent. For some programs (mostly piano programs), the Aux 2 send level is set in dB and works more like a traditional send on an audio mixing board. The level of signal sent to the Chain is set in dB, the higher the value the more processed signal you will hear. When the Aux 2 send level is set in dB, the unprocessed signal does not get turned down as the Aux 2 send is turned up.

### **Pre/Post Ins**

The Pre/Post Insert parameter determines the point at which the auxiliary effect is applied to the signal.

When this parameter is set to Post, the Forte applies the auxiliary effect to the signal post insert, i.e., after the insert effect has been applied.

When this parameter is set to Pre, the Forte applies the auxiliary effect to the signal pre insert.

To hear a program put through two effects Chains in series (i.e., route the processed Insert signal through the Aux 1 Chain), choose your desired effects Chains for the Insert and Aux 1, set each bus Output to Main, and set the Aux 1 Send parameter to 100%. Then, set the Pre/Post Insert parameter to Post.

To hear a program put through two effects Chains in parallel (i.e., don't route the processed Insert signal through the Aux 1 Chain), choose your desired effects Chain for the Insert and either Aux, set each bus Output to Main, and set the Aux Send parameter to either 50% or 0 dB. Then, set the Pre/Post Insert parameter to Pre for the desired aux.

## Program Edit Mode

### Program Pages

With respect to each other, the Aux 1 and Aux 2 are always in parallel, that is, the output of one Aux Chain can not be processed by the other Aux Chain.

## COMMON Page

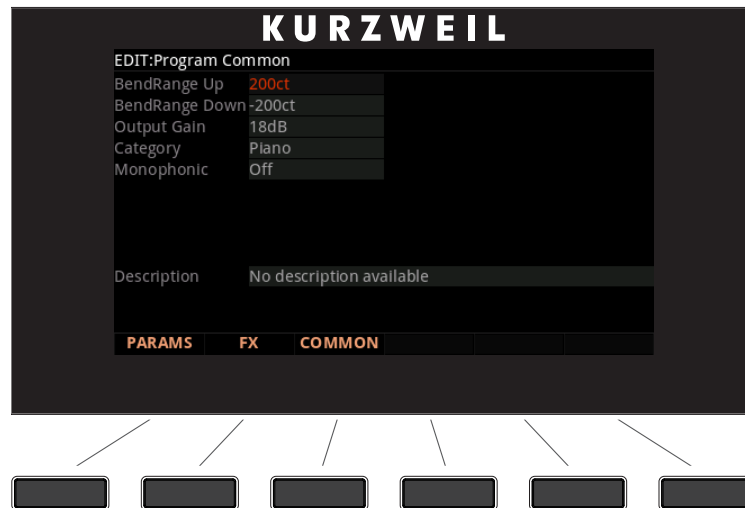

The Common Page allows adjustment of a number of general parameters for the program.

Parameter	Range Of Values	Default Value
BendRange Up	-7200 cents to +7200 cents	200 ct
BendRange Down	-7200 cents to +7200 cents	-200 ct
Output Gain	-96 to 24dB	0dB
Category	None, 20 Categories	None
Monophonic	Off, On	Off
Legato	Off, On	On
Portamento	Off, On	On
Portamento Rate	1-3000 Key/s	70 Key/s
Mono Sample XFade	Off, On	On

### BendRange Up & BendRange Down

Use these parameters to define how much the pitch will change when you move the Pitch Wheel. You can set either Bend parameter to bend by up to 72 half-steps up or down. Pitch values are set in cents, where 100 cents = 1 half-step (1 semitone).

For both Bend parameters, positive values will cause the pitch to bend up, while negative values will cause the pitch to bend down. Large positive values can cause samples to bend to their maximum upward pitch shift before the Pitch Wheel is fully up (or down). This will not happen when bending the pitch down.

## **Output Gain**

Adjusts the output level of the currently selected program by up to -96 dB or +20 dB.

## **Category**

This parameter sets the category that the program will be grouped into when you press one of the Category buttons from the Program mode main page.

For example, if you were to edit a program in the Leads category that you want to use primarily as a Synth Bass, you could make it appear in the Syn Bass category by changing this parameter to SynBass. Set a category by using the Alpha Wheel or +/- buttons. In addition to the category set here, all edited programs can be viewed by pressing the User button.

## **Monophonic**

When the Monophonic parameter is set to “Off”, the current edited program is polyphonic—it can play up to 128 notes at a time (or fewer notes at a time if each note plays multiple layers).

When the Monophonic parameter is set to “On”, the program will play only one note at a time, and the Legato parameter and the four Portamento parameters will appear on the Program Common page. Only monophonic programs can use Legato and Portamento. The Monophonic, Legato and Portamento parameters are not available for KB3 programs.

## **Legato**

The Legato parameter is only available when the Monophonic parameter is set to “On”. The Legato parameter is useful for emulating legato techniques of various acoustic instruments. When the Legato parameter is set to “On”, a played note will trigger a new amplitude envelope only if no other notes in the program are being held. Notes played while other notes are being held will use the previously triggered amplitude envelope of the first note that was played.

## **Portamento**

The Portamento parameter is only available when the Monophonic parameter is set to “On”. When the Portamento parameter is set to “On”, notes played in a monophonic Program can glide from the pitch of the previously played note to the pitch of the currently played note.

Portamento is often used in synthesizer lead sounds, or to mimic acoustic instruments like violin and bass, where a pitch glide is achieved by sliding a finger along a vibrating string.

See Portamento Rate (below) to set the Portamento glide speed, and Attack Portamento (below) to set the way that Portamento responds to played notes. See the Mono Sample XFade parameter (below) to improve the sound of Portamento in programs that use multiple samples.

#### **Portamento Rate**

The Portamento Rate parameter determines how fast a note glides from the pitch of one note to the pitch of the next played note. The value selected for this parameter determines how many seconds a note takes to glide one semitone (half-step) toward the pitch of the next played note. For example, at a setting of 12 keys/second the pitch would glide an octave every second. Select a higher value for a faster pitch glide, or a lower value for a slower pitch glide. The list of values is nonlinear; that is, the increments get larger as you scroll to higher values.

The Portamento Rate parameter determines how fast a note glides from the pitch of one note to the pitch of the next played note. The value selected for this parameter determines how many seconds a note takes to glide one semitone (half-step) toward the pitch of the next played note. For example, at a setting of 12 keys/second the pitch would glide an octave every second. Select a higher value for a faster pitch glide, or a lower value for a slower pitch glide. The list of values is nonlinear; that is, the increments get larger as you scroll to higher values.

#### **Mono Sample XFade**

When applying portamento to programs that use multiple samples (Acoustic Guitar, for example), the Forte will play more than one sample root as the pitch glides from the starting pitch to the ending pitch. This may cause a small click at each sample root transition. You can eliminate clicks by setting the Mono Sample XFade parameter to On. When the Mono Sample XFade parameter is set to On, the Forte performs a crossfade at each sample root transition to eliminate clicks.

# Chapter 8

## Multi Mode

This chapter will help familiarize you with the features of Multi Mode.

Multis are configurations of four Zones (explained below in “About Multi Mode”), each of which may have its own Program, controller assignments, and MIDI transmit channel. A Zone can also be configured to control an external sound module or computer software through a MIDI or USB cable.

### About Multi Mode

To enter Multi Mode from another Mode, press the Multi Mode button.

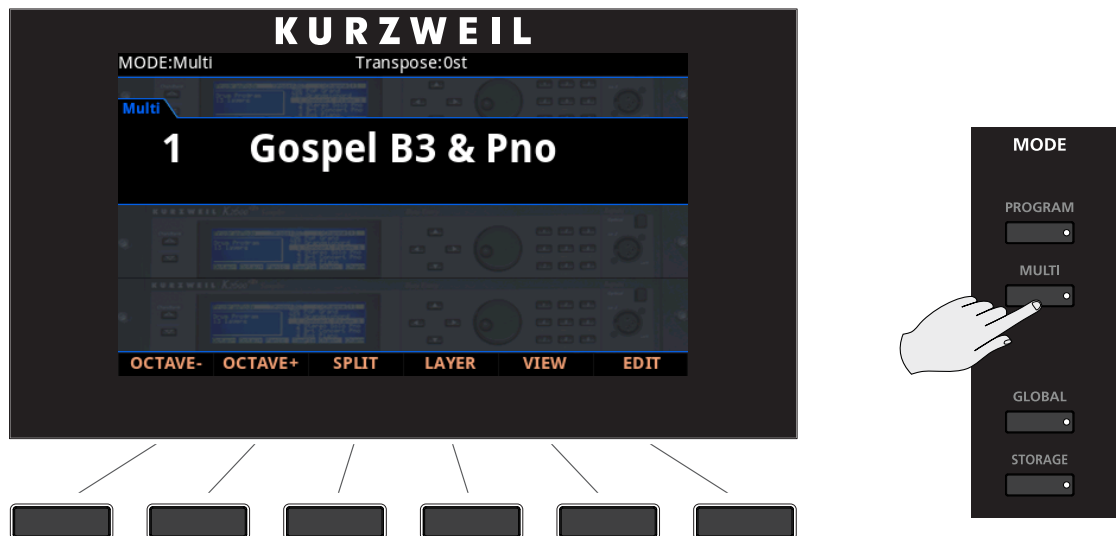

While you are in Multi Mode, the Multi button’s indicator LED is illuminated.

When you enter Multi Mode after powering on the Forte, Multi 1 will be selected, or the Multi that was selected the last time Global mode was exited.

## Selecting Multis

When you are in Multi Mode, there are a few ways to select Multis.

- The Alpha Wheel, Next and Previous buttons and the Cursor buttons allow you to advance through the Multis one at a time.
- Typing in a Multi ID with the keypad function of the Category buttons, followed by pressing the Enter button.
- Pressing the User Button goes to the first saved user Multi.
- If a Multi is assigned to a Favorite Button, pressing that button will go directly to the assigned Multi, changing Modes if necessary.

## The Color Display

In Multi Mode, the top line of the display shows the current Mode, MIDI transposition, and MIDI In/Out activity indicators. If Favorites view is selected and the Global Mode User Type parameter has been set to Advanced, the current Favorites Bank number will be shown in the top right corner of the screen.

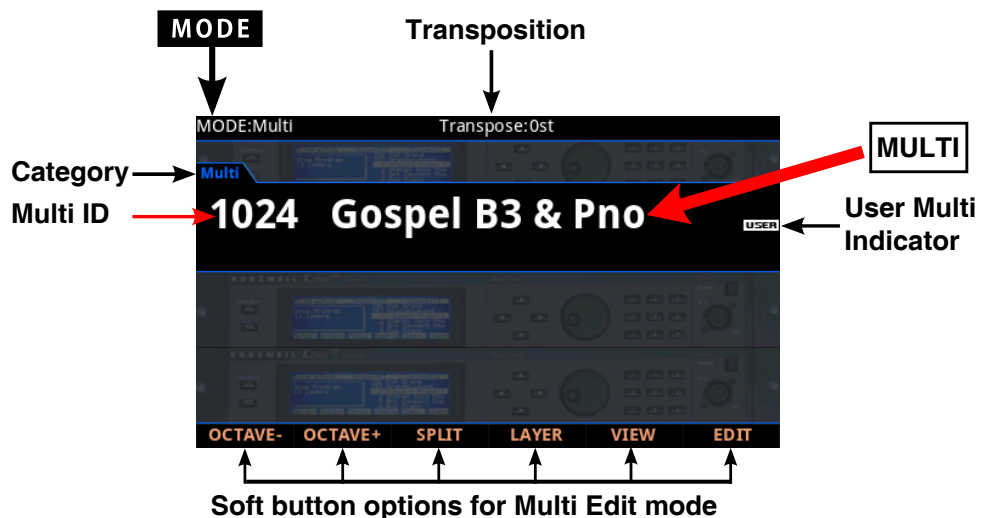

If the currently selected Multi is a User Multi, the “USER” indicator will appear to the right side of the Multi ID number and name.



**NOTE :** The display can be changed to an alternate layout by pressing the “VIEW” soft button, or by changing the “Display” parameter in Global Mode.

### Pop-Up Messages

Some actions cause the display to show pop-up messages. After a short time the display returns to show the current Multi.

### MIDI In/Out Activity Indicators

MIDI In/Out activity indicators are displayed at the top of the screen (shown as 2 MIDI port symbols with “I” for “in” and “O” for “out”). These indicators briefly light up when MIDI has been recently sent to or received by the Forte’s MIDI/USB ports. If the symbol is green, this indicates there has been MIDI activity on that port in the last few seconds. If the symbol is red, this indicates there has been communication with the external software editor on that port in the last few seconds. If the symbol is grey, this indicates there has been no MIDI activity on that port in the last few seconds.

## Alpha Wheel & Previous (–) and Next (+) Value Buttons

Use the Alpha Wheel or the Value buttons (to the right of the display below the Alpha Wheel) to change the current Multi. Turning the Alpha Wheel counter-clockwise or pressing the Previous button will select the previous Multi, and turning the Alpha Wheel clockwise or pressing the Next button will select the next Multi. When the highest or lowest Multi is reached, the list will wrap back to the first or last Multi, respectively.



## Value Jump Buttons

In Multi Mode, the Value Jump double button press increments the Multi IDs by 10 with each press. If the currently selected Multi is ID 4, using the Value Jump double button press will select Multi ID 14. If pressed again, Multi ID 24 will be selected, and so on. When the end of the Multi list is reached, a Multi at the beginning of the list will be selected.

## The Cursor Buttons

Use the Cursor buttons (to the right of the display) to change the current Multi. The Right and Down arrowed buttons will increment the current Multi, and the Left and Up arrowed buttons will decrement the current Multi.

## Multi Mode

### Selecting Multis

## Category Buttons

In Multi Mode, Multis are not organized by category. Because of this, the Keypad button LED is always lit in Multi Mode, and the category buttons function as a numeric keypad. To select a Multi by ID number, use the keypad function of the Category buttons to type an ID number, followed by pressing the Enter button.

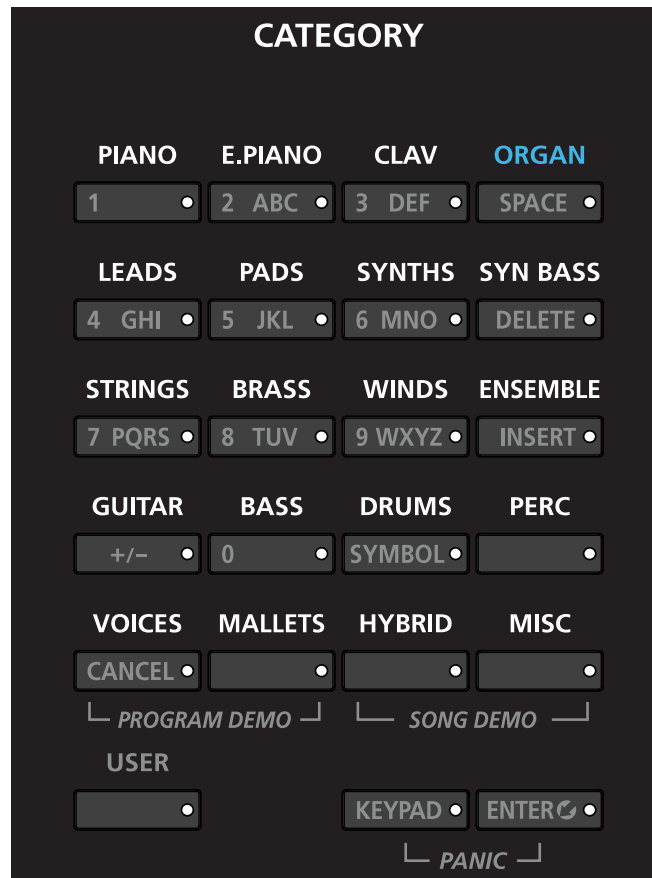

## Choosing Favorites

You can save ten Favorite Multis (or Programs) from any Category to the ten Favorite Buttons beneath the display. Once saved, these favorite Multis can be recalled from any Mode with a single button press.

To save the currently selected Multi to a Favorite Button, press and hold a Favorite Button until the display shows a message indicating the favorite has been saved.

If a Favorite button has a Program saved to it and is pressed, Forte will leave Multi Mode and enter Program Mode.

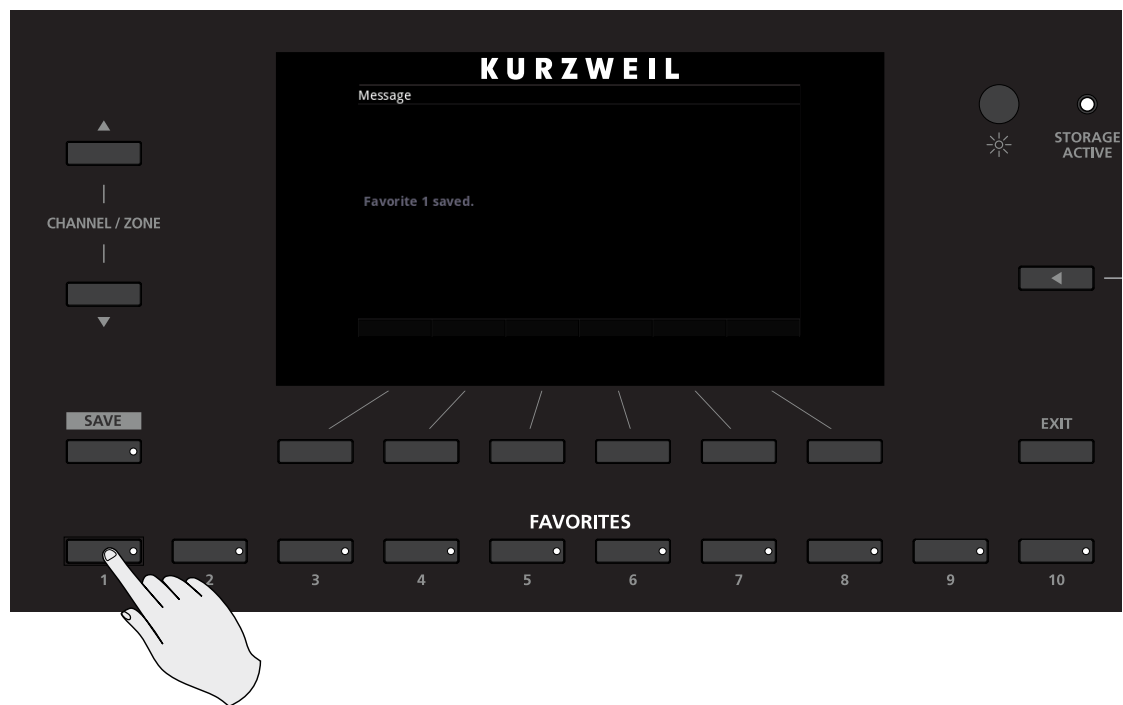

### Favorites View and Favorites Banks

To view the names of Programs and Multis stored as Favorites, press the View soft button until you see the Favorites listed at the bottom of the display, or set the Global Mode “Display” parameter to “Favorites.” If Favorites view is selected and the Global Mode User Type parameter has been set to Advanced, you can use the Channel/Zone buttons to scroll through 16 banks of 10 Favorites, allowing you to save and access 160 Favorites. When Favorites view is selected and the Global Mode User Type parameter has been set to Advanced, the current Favorites Bank number will be shown in the upper right hand corner of the screen.

## About Zones

Zones are the independent regions of the keyboard that make up a Multi.

A Multi has four Zones, each one having its own Program, controller assignments, and MIDI transmit channel. Zones can be mutually exclusive regions of the keyboard, or they can overlap. A Zone can also be configured to control an external sound module or computer software through a MIDI or USB cable.

## Muting Zones

Pressing a Zone button will mute or unmute the Zone.

An active/unmuted Zone button has a lit green LED. The LED of an inactive/muted Zone button is not lit.

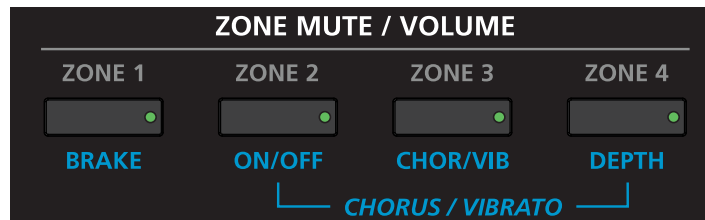

## Transposition

The Transpose buttons can be used to change the tuning of notes played on the Forte keyboard in semitones (ST), also known as half-steps. This is a convenient way to change the key of a song without learning to play it in a different key. The Transpose buttons are located to the left of the keyboard, above the Pitch and Mod Wheels. The Transpose buttons also transpose MIDI notes sent to the USB and MIDI out ports.

Press the Transpose - or + buttons to transpose the Forte keyboard down or up by one semitone. The top line of the display shows the current transposition value.

Pressing both Transpose - and + simultaneously will reset the transposition to 0.

To transpose up and down by octave intervals (12 ST), press the OCTAVE- and OCTAVE+ soft buttons underneath the display.

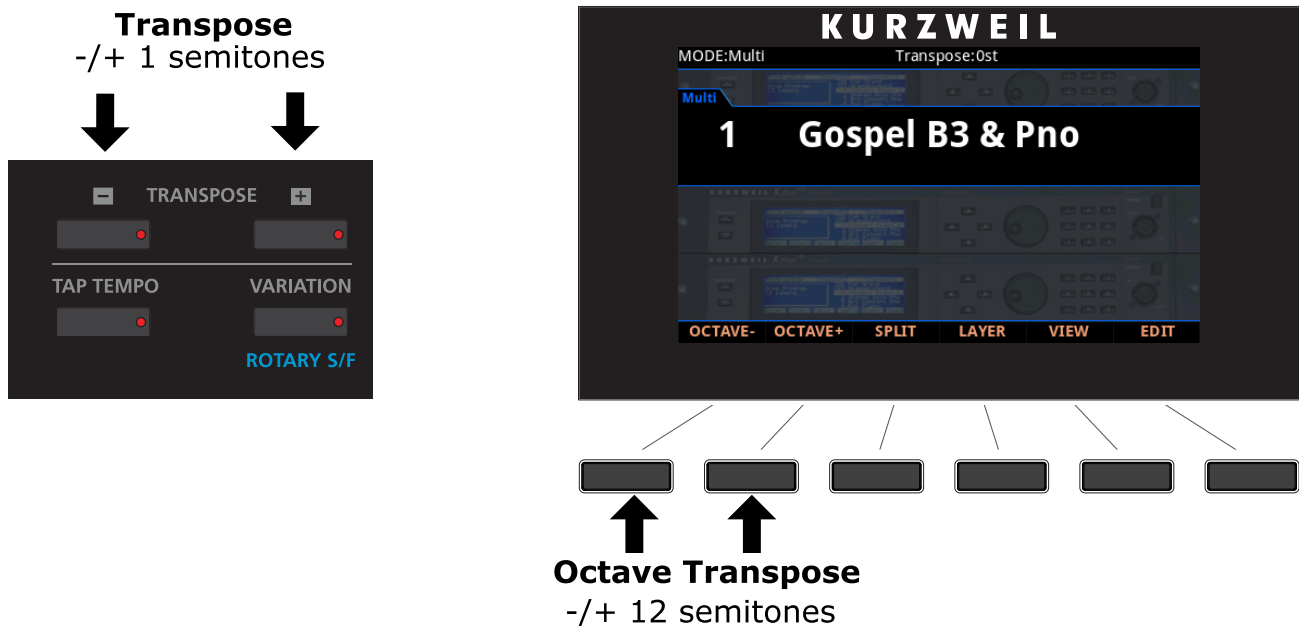

The maximum transposition value possible is  $\pm 36$  semitones.

The LEDs of the Transpose buttons indicate whether the current Multi is transposed up (Transpose + LED is lit) or transposed down (Transpose - LED is lit). When there is no transposition, neither Transpose button is lit.



**NOTE :** Transposition is applied to all Programs in the Zones within the Multi. The Zone layout on the keyboard however still remains fixed.

# Parameter Assignments

In Multi Mode, each Multi has factory-set Program and Effect parameters assigned to physical controllers (Sliders, Switch buttons, Mod Wheel, and Pedals). A parameter assignment can modify an instrument sound during a performance to add variation or expression. Moving a controller changes the value of the parameter. Any time you do this, the display shows the Controller name, assigned parameter, and value.



 **NOTE :** Parameter assignments may not be visible if the VIEW soft button has been pressed, or the “Display” parameter in Global Mode has been changed.

## Controller Conventions

In Multi Mode, the Zone Mute Switches above Sliders A through D control the Active/Muted status of Zones 1 through 4. In the Factory Multis, Sliders A through D generally control the volume for Zones 1 through 4. Sliders H and I generally control Delay and Reverb amount. The remaining Sliders and Switches generally control various effects and synthesis parameters.

## The Split Function

Pressing the Split soft button while in Multi Mode performs the Split Function. The Split Function allows you to split Multis such that keys in one region of the keyboard produce different sounds than another region.



When you create a Split in a Multi, you are in fact activating a new Zone within the current Multi. If the current Multi already has its maximum of four active Zones and you press the Split Function soft button, then a message will appear on the display indicating that you have reached the maximum of four active Zones. Once you have saved your Split, you can continue to add Split or Layer Zones to the Multi until you reach the maximum of four active Zones.

The Split Function is convenient, as you do not need to use Multi Edit Mode to configure Zone key ranges, Programs, and volumes. You can simply press the Split button, and the Forte automatically activates another Zone in the Multi for you. The previously active Zones are used in the right hand of the Split. If a previously active Zone has a Key Range below the default split point (C4), then that Zone will remain in the left hand of the split. After this you can choose a “Split Program” that will be used in the left hand of the Split as the Program for the newly activated Zone.

There are four parameters (described below) that determine the behavior of the Split. Use the cursor buttons to access each of the Split parameters for each active Zone.

## Multi Mode

---

### The Split Function

#### Program

The Program parameter for the first available Zone determines the Program for the left-hand side of the Split, also known as the “Split Program”. This parameter is selected by default when performing the Split function, and the default Split Program (245 Finger Bass) will be selected. Choose a Split Program using the Category buttons, the Alpha Wheel, the Previous/Next buttons, or enable the Keypad button and type an ID number followed by the Enter button.

#### Volume

To change the volume of a Zone, use the cursor buttons to select the Volume parameter for one of the Zones. To set a volume, use the Alpha Wheel, the Previous/Next buttons, or use the keypad function of the Category buttons to type a volume (0-127) followed by the Enter button.

#### Key Range

You can adjust the boundary between the left and right hand Programs on the keyboard by adjusting the Key Range low and Key Range high parameters for each Zone. The keyboard display for each Zone shows a visual indication of the Key Range by dimming keys that are outside of the Key Range.

To change the Key Range of a Zone, use the cursor buttons to select the Key Range low or Key Range high parameters for one of the Zones. Key Range low and Key Range high are the left and right parameters, respectively, below the Key Range label. With one of these parameters selected, set the Key Range by using the Alpha Wheel, the Previous/Next buttons, or use the keypad function of the Category buttons to type a key number (0-127) followed by the Enter button. With Key Range low or Key Range high selected, the value can also be changed by holding the Enter button, then pressing the desired key.

#### Pan

To change the panning of a Zone (left/right stereo placement), use the cursor buttons to select the Pan parameter for one of the Zones. To set a Pan value, use the Alpha Wheel, the Previous/Next buttons, or use the keypad function of the Category buttons to type a pan value (0-127) followed by the Enter button. A value of 0 is full left, 64 is center, and 127 is full right. Other values will move the stereo placement in between these positions. A value of “None” will use the last pan value used by the Zone’s MIDI channel. A value of “None” can be entered by scrolling below 0, or by using the keypad function of the Category buttons to type negative 1 by pressing the +/- button and then the 1 button, followed by the Enter button.

## **Saving a Split**

After setting the Split parameters, press the Save button to the left of the display to begin the saving process. See “Save User Multis” for details on saving. A Multi name is automatically created using half of the Zone 1 Program name and half of the Zone 2 Program name. This name can be edited during the saving process.

Once you have saved your Split, you can continue to add Split or Layer Zones to the Multi until you reach the maximum of four active Zones. Also, once you have saved your Split, you can use Multi Edit Mode to edit controller assignments (like effects controls and sustain pedal per Zone), transposition per Zone, and other Multi parameters. (See “Multi Edit Mode” on page 9-1 for details.)

## Multi Mode

### The Layer Function

# The Layer Function

The Layer Function is convenient, as it automatically configures a Multi to function as a Layer by setting Zone key ranges and Programs.

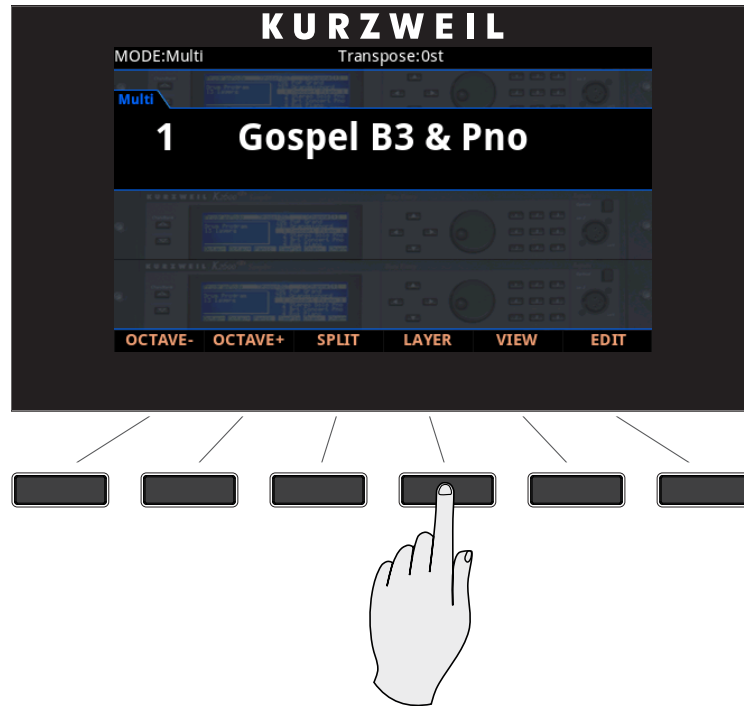

When you create a Layer in a Multi, you are in fact activating a Zone within the current Multi. If the current Multi already has its maximum of four active Zones and you press the Layer Function soft button, then a message will appear on the display indicating that you have reached the maximum of four active Zones. Once you have saved your Layer, you can continue to add Layer or Split Zones to the Multi until you reach the maximum of four active Zones.

The Layer Function is convenient, as you do not need to use Multi Edit Mode to configure Zone key ranges, Programs, and volumes. You can simply press the Layer soft button, and the Forte automatically activates another Zone in the Multi to layer with the previously active Zones. After this you can choose a “Layer Program” that will be used as the Program for newly activated Zone.

There are four parameters (described below) that determine the behavior of the Layer. Use the cursor buttons to access each of the Layer parameters for each active Zone.

### **Program**

The Program parameter for the first available Zone determines the “Layer Program” that will be layered on top of the previously active Zones. This parameter is selected by default when performing the Layer function, and the default Layer Program (152 Add a Pad 2) will be selected. Choose a Layer Program using the Category buttons, the Alpha Wheel, the Previous/Next buttons, or enable the Keypad button and type an ID number followed by the Enter button.

### **Volume**

To change the volume of a Zone, use the cursor buttons to select the Volume parameter for one of the Zones. To set a volume, use the Alpha Wheel, the Previous/Next buttons, or use the keypad function of the Category buttons to type a volume (0-127) followed by the Enter button.

### **Key Range**

By default the Layer Program covers the whole range of the keyboard, but if desired you can adjust the layer Key Range to make the Layer Program cover only a certain range of the keyboard. You can adjust the boundary of each Program on the keyboard by adjusting the Key Range low and Key Range high parameters for each Zone. The keyboard display for each Zone shows a visual indication of the Key Range by dimming keys that are outside of the Key Range.

To change the Key Range of a Zone, use the cursor buttons to select the Key Range low or Key Range high parameters for one of the Zones. Key Range low and Key Range high are the left and right parameters, respectively, below the Key Range label. With one of these parameters selected, set the Key Range by using the Alpha Wheel, the Previous/Next buttons, or use the keypad function of the Category buttons to type a key number (0-127) followed by the Enter button. With Key Range low or Key Range high selected, the value can also be changed by holding the Enter button, then pressing the desired key.

### **Pan**

To change the panning of a Zone (left/right stereo placement), use the cursor buttons to select the Pan parameter for one of the Zones. To set a Pan value, use the Alpha Wheel, the Previous/Next buttons, or use the keypad function of the Category buttons to type a pan value (0-127) followed by the Enter button. A value of 0 is full left, 64 is center, and 127 is full right. Other values will move the stereo placement in between these positions. A value of “None” will use the last pan value used by the Zone’s MIDI channel. A value of “None” can be entered by scrolling below 0, or by using the keypad function of the Category buttons to type negative 1 by pressing the +/- button and then the 1 button, followed by the Enter button.

## Saving a Layer

After setting the Layer parameters, press the Save button to the left of the display to begin the saving process. A Multi name is automatically created using half of the Zone 1 Program name and half of the Zone 2 Program name. This name can be edited during the saving process. See “Save and Delete User Multis” on page 9-30 for details on saving.

Once you have saved your Layer, you can continue to add Split or Layer Zones to the Multi until you reach the maximum of four active Zones. Also, once you have saved your Layer, you can use Multi Edit Mode to edit controller assignments (like effects controls and sustain pedal per Zone), transposition per Zone, and other Multi parameters. (See Multi Edit Mode on page 9-1 for details.)

## Save User Multis

To save changes to the current User Multi, or to save a changed Factory Multi to a User Category, press the Save button once.



You can save Multis with ID numbers from 1024 to 2047. If you are saving a Multi that has not been previously edited, the next available unused ID number will be selected. If you are saving a previously edited User Multi, the ID number that the Multi was last saved with will be selected. Press the Value Jump double button press (Previous + Next) to toggle between selecting the ID number that the Multi was last saved with and the next available unused ID number. When viewing the Save Dialog, you can quickly save the Multi to the displayed ID number by pressing the Save button again.

## Changing ID Numbers

To change the ID number, turn the Alpha Wheel or use the Value buttons to select the new ID number. The label underneath indicates if it is an “Unused ID”. You can also use the keypad function of the Category buttons to type an ID number, followed by pressing the Enter button.

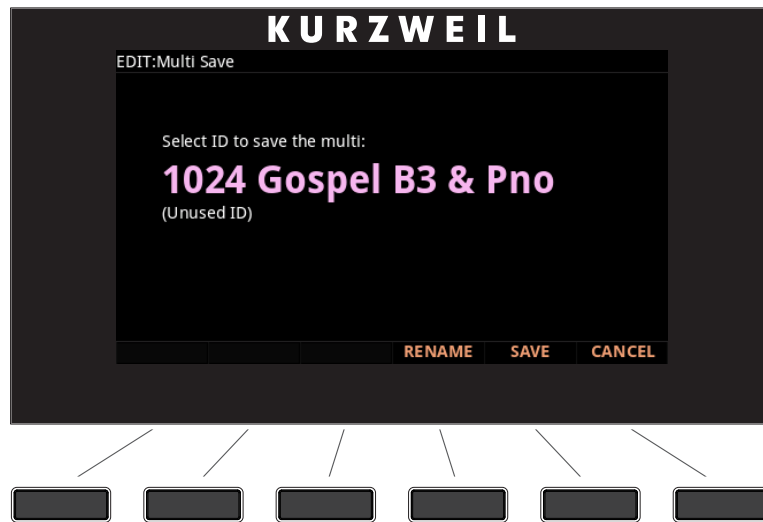

If you select an ID currently in use, the display will indicate if you want to “replace” the Multi currently in that location. The Multi name and ID is indicated.

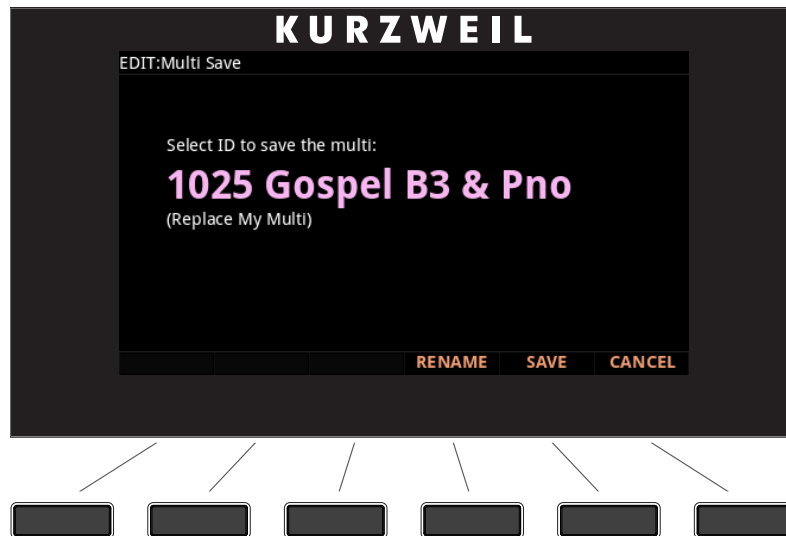

Confirm overwriting of the existing Multi by pressing Save, or choose a different ID.

## Naming a User Multi

To rename the Multi, first press the Rename soft button. You will see the naming screen in the display.

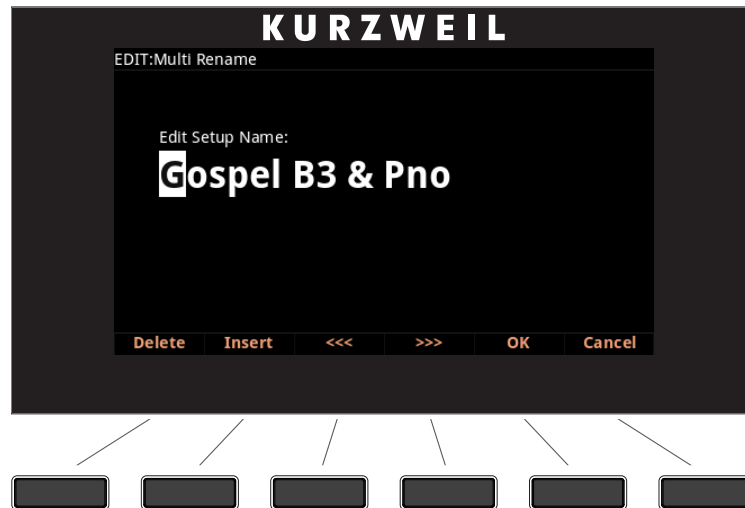

The display shows the current Multi name. Multi names can total 16 characters in length. Use the letters and numbers printed on the Category buttons to enter the new Multi name. Rotating the Alpha Wheel or using the Value buttons can also change the Multi name.

Use the Left/Right cursor buttons or <<< >>> soft buttons to move the cursor. Press the +/- button to switch between upper and lower case characters (all characters will be upper case until you press the +/- button again).

Use the Space button to change the current character to a space, the Insert button to insert a blank space (the selected character and all characters to the right will move one space to the right), and the Delete button to delete the current character (all the characters to the right will move one space to the left).

## Multi Mode

### Save User Multis

## Saving a User Multi

Press the Save button or Save soft button to complete the saving process, or press the Cancel soft button to exit without saving. After successfully saving, the Multi will be selected in Multi Mode. To find the Multi again later, press the User button and scroll to the Multi ID. You can also type the Multi ID number, then press the Enter button.

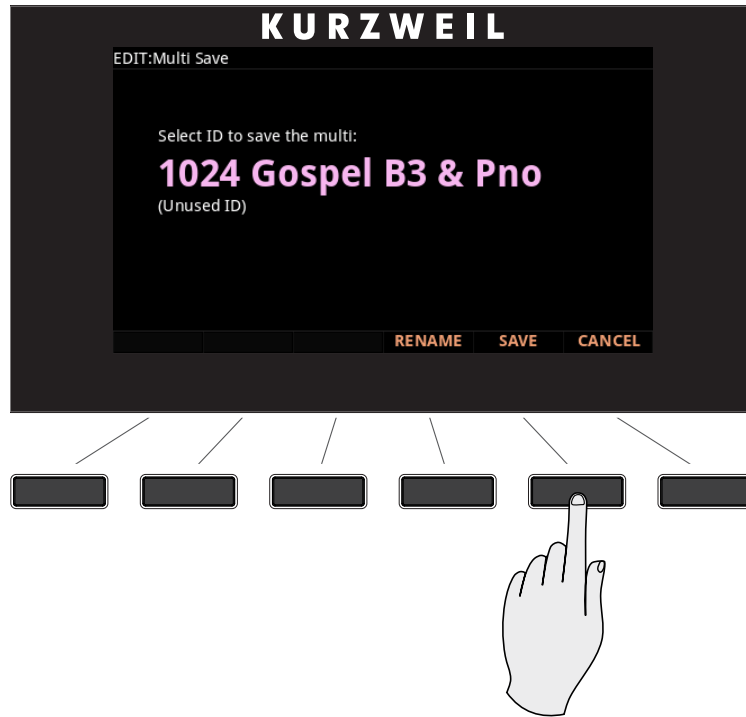

# Chapter 9

## Multi Edit Mode

This chapter will help familiarize you with the features of Multi Edit Mode.

### About Multi Edit Mode



**NOTE :** Before you read this chapter, be sure to read **Multi Mode** on page 8-1 for a full description of Multis.

Multi Edit Mode allows you to edit and create Multis and gives you access to a Multi's Common parameters and Zone specific parameters. Multis are configurations of four Zones, each of which may have its own Program, controller assignments, and MIDI transmit channel. A Zone can also be configured to control an external sound module or computer software through a MIDI or USB cable.

In Multi Edit Mode, you can customize the Program, controller assignments, and MIDI transmit channel of the Zones in a Multi, in addition to many other parameters. Any Multi can be edited in Multi Edit Mode and saved to one of the 1024 User IDs.

To enter Multi Edit Mode, first press the Multi Mode button to enter Multi Mode, and then press the EDIT soft button.

# Multi Edit Mode

## About Multi Edit Mode

---



Once you are in Multi Edit Mode, press the soft buttons at the bottom of the screen to navigate to each of the Multi Edit Mode pages. See the sections below for details on navigating and changing parameters and Zones. All parameters apply only to the currently selected Zone, except for parameters on the Common Page and certain controller parameters, which apply to all Zones.

# Selecting Parameters

## The Display

In Multi Edit Mode, the top line of the display shows the current Mode, Page, and current selected Zone.

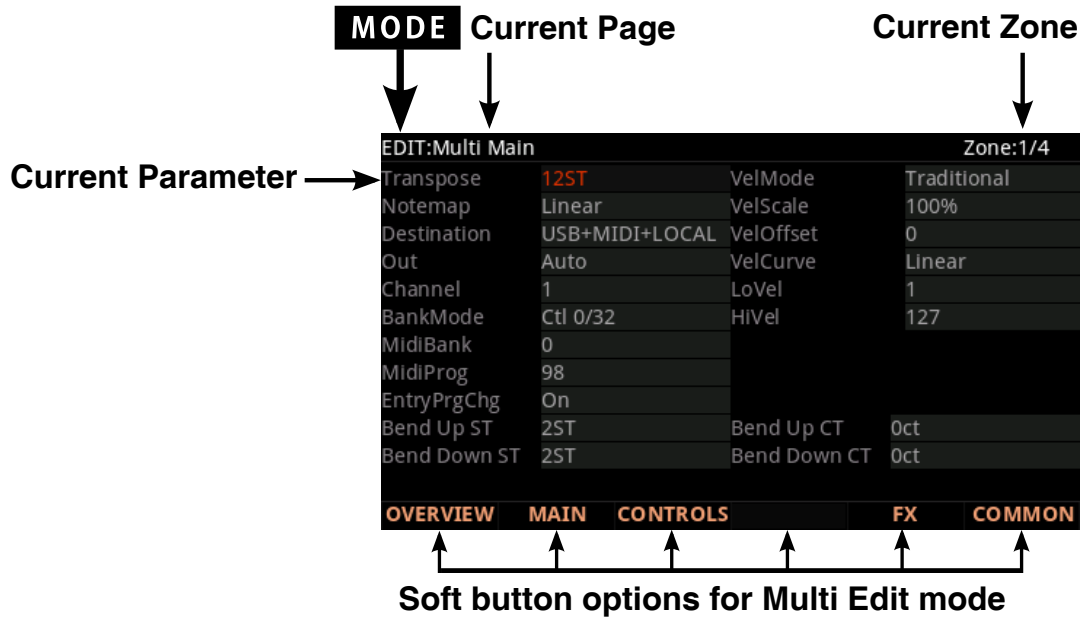

## Changing Zones



Use the Channel / Zone Up and Down buttons to change the currently selected Zone.

The top right corner of the display of the MAIN & CONTROLS pages always shows the currently selected Zone out of the four Zones. Pressing the Zone Up button in Zone 4 will wrap to Zone 1 and pressing the Zone Down button in Zone 1 will wrap to Zone 4.

## Multi Edit Mode

### Selecting Parameters

On the Multi Edit Overview page the Channel/Zone Up/Down buttons will change Zones in reverse order from how they do on other Multi Edit pages. Pressing Zone Down will select a higher Zone and pressing Zone Up will select a lower Zone. The buttons are reversed on this page so that pressing Zone Up/Down will move you visually up/down on the display. A simultaneous double button press of Zone Up/Down will jump to Zone 1.

## Alpha Wheel & Previous (–) and Next (+) Value Buttons

Use the Alpha Wheel or the Value buttons, to the right of the display below the Alpha Wheel, to change the selected parameter value. Turning the Alpha Wheel counter-clockwise or pressing the Previous button will select the previous value and turning the Alpha Wheel clockwise or pressing the Next button will select the next value.

## Assign

Assign is the secondary function of the Enter button. You can use the Assign function to quickly select parameters or set values for parameters by holding the Enter button while moving Forte controllers (Sliders, Switch buttons, Keys, Mod Wheel, and Pedals).

ENTER ↻

Parameters that can use the Assign function are indicated by showing the Assign symbol in the top right corner of the display when selected.

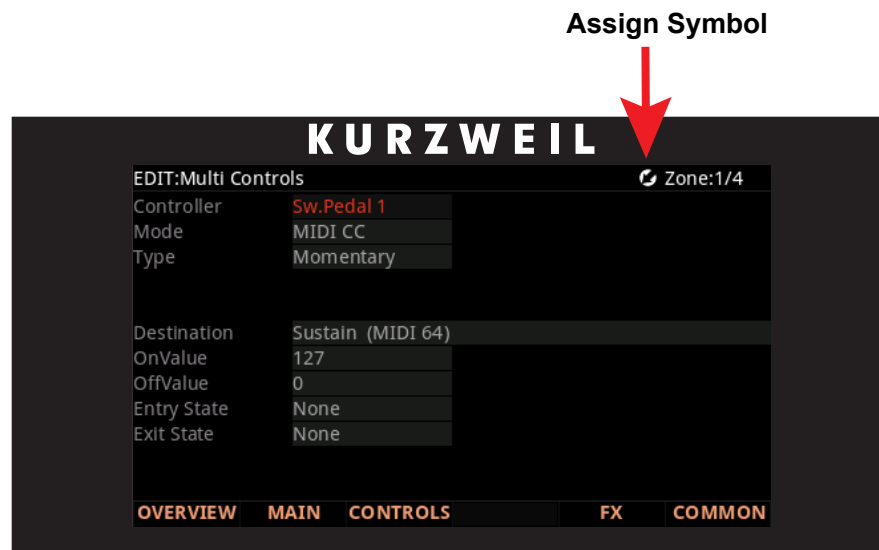

Pressing a key, switch, or moving a controller while holding down the Enter button will perform Assign in the following cases.

### **Enter + Controller**

In Multi Edit Mode on the Controls page, when the Controller parameter is selected, holding the Enter button and moving a controller (a Slider, Switch button, Mod Wheel or Pedal) will jump to selecting that controller in the current Zone. This allows you to quickly select a controller.

In a Controller destination field in Multi Edit Mode, Enter + Controller will assign the Destination of the touched controller to the selected controller.

Using Enter + Controller in an OnValue or OffValue field or in an Entry Position or Exit Value field, will set the value of that controller to the field value. For example if you want to set an OnValue to a value of 100, you can hold Enter and move a controller to quickly set OnValue to 100.

### **Enter + Key**

In Multi Edit Mode, on the Overview page, with the Low Key Range or High Key Range parameter selected, hold the Enter button and strike a key to set the Low Key or High Key. This will also work on the Control page with a Switch selected, when Mode = Chord. The value of the Key fields can be set using Enter + Key.

## **Zone Parameters**

Each of the four Zones in a Multi has multiple parameters that determine its behavior. Since the Zones of a Multi are independent of each other, changing a parameter for a certain Zone will not affect the parameters of any other Zone. There are some exceptions to this, for example, the parameters on the Common Page are common to all 4 Zones. Also, on the Controllers Page for Switch Controllers, the parameters Type, Entry State, and Exit State are common to all 4 Zones. Lastly, on the Controllers Page for Continuous Controllers, the parameters Entry Position and Exit Value are common to all 4 Zones.

The Zone parameters for each page are explained in detail below.

# OVERVIEW Page

The Overview Page shows all 4 Zones in an easy graphical layout. The current Program, Volume and Panning position of the Zone, along with the state and active keyboard region can be quickly set on this page.

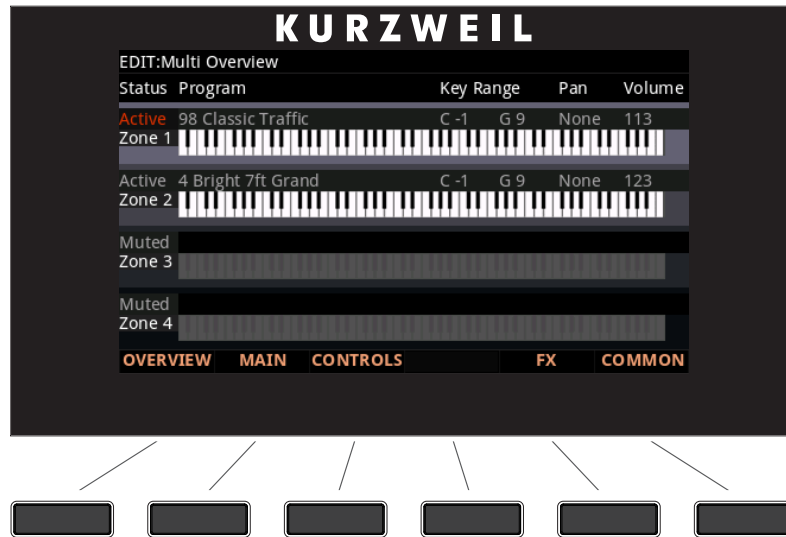

Parameter	Range Of Values	Default Value
Status	Active, Muted	Active
Program	Program List	-
Key Range	C-1 to G9	C-1 to G9
Pan	None, 0 to 127	64
Volume	None, 0 to 127	127

## Status

The Status parameter determines whether the currently selected Zone is active or muted. You can set this parameter to either of two states: Active or Muted.

## Program

The Program parameter determines the Program to be loaded for the currently selected Zone. You can set this parameter to any Forte Program (1 – 2047). The display shows the Program number and name.

The Value Jump double button press (Previous and Next buttons) jumps to selecting the first Program of each Category, as well as the Category Default Program of each Category (if a Category Default Program has been set).

## **Key Range**

The Key Range is made up of two parameters that define the region of the keyboard the Zone is allocated to. The value to the left affects the lowest key, the value to the right the upper key. The keyboard graphic in the Overview page clearly illustrates the Zone's current region

The lowest key determines the lower boundary of the currently selected Zone. You can set this parameter to any note from C-1 to G9. If, for example, you set the lowest key to C4, then only keys at or above C4 will trigger a note for the currently selected Zone. Keys below C4 will not trigger a note.

The highest key parameter determines the higher boundary of the currently selected Zone. You can set this parameter to any note from C-1 to G9. If, for example, you set the highest key to C4, then only keys at or below C4 will trigger a note for the currently selected Zone. Keys above C4 will not trigger a note.

You can also set the lowest key higher than the highest key and vice versa. This allows you to split a Zone into two areas where the lowest and highest keys now define the region that the Zone does not play on.

## **Pan**

The Pan parameter determines the Pan MIDI message that the currently selected Zone sends when the Multi is loaded. You can set this parameter to any pan setting from None, 0 (full left pan) to 127 (full right pan). To pan to center, select 64 for this parameter.

None can be entered as -1 on the keypad.

## **Volume**

The Volume parameter determines the Volume MIDI message that the currently selected Zone sends when the Multi is loaded. You can set this parameter to any volume setting from None, 0 to 127.

None can be entered as -1 on the keypad.

## Multi Edit Mode

### MAIN Page

# MAIN Page

The Main Page shows the current settings that are specific for the currently selected Zone. The top right hand corner of the display indicates the currently selected Zone of a total of 4 Zones.



Parameter	Range Of Values	Default Value
Transpose	-128 to +127 ST (semitones)	0 ST
Notemap	Off, Linear, 1 of 2, 2 of 2, 1 of 3, 2 of 3, 3 of 3, 1 of 4, 2 of 4, 3 of 4, 4 of 4, Inverse, Constant	Linear
Destination	NONE, LOCAL, MIDI, MIDI+LOCAL, USB, USB+LOCAL, USB+MIDI, USB+LOCAL+MIDI	USB+LOCAL+MIDI
Out	Auto, A, B	Auto
Channel	1 to 16	1
BankMode	None, Ctl 0, Ctl 32, Ctl 0/32, K2600	Ctl 0/32
MidiBank	None, 0 to 16383	-
MidiProg	(Depends on BankMode)	-
EntryPrgChg	On, Off	On
Bend Up ST	Prog, 0 to 127 ST (semitones)	2 ST
Bend Down ST	Prog, 0 to 127 ST (semitones)	2 ST
VelMode	Traditional, Fixed	Traditional
Velocity	0 - 127 (when VelMode = Fixed)	127
VelScale	-300 to +300 %	100 %
VelOffset	-128 to 127	0
VelCurve	Linear, Compress, Expand, Crossfade, Bump, Rvrs Linear, Rvrs Expand, Rvrs Compress, Rvrs Crossfade	Linear
LoVel	1 to 127	1
HiVel	1 to 127	127
Bend Up CT	Prog, 0 to 100 ct (cents)	0 ct
Bend Down CT	Prog, 0 to 100 ct (cents)	0 ct

## Transpose

The Transpose parameter determines the transposition for the currently selected Zone. You can set this to any value from -128 semitones to 127 semitones.

## Note Map

Note Map lets you change the way notes are sent from the Forte.

The default setting is Linear: all notes go out as played. Pressing the Minus button takes you to Off; no notes are sent, but controllers and other non-note data are.

Setting Note Map to Inverse effectively turns the keyboard upside-down, with the highest key being A 0 and the lowest C 9. If you set Note Map to Constant, all of the keys on the keyboard will play the same note. The note defaults to C4, but you can change this with the Transpose parameter. This works well when you want the sound from a particular key to play with every note of another zone. For example, playing a ride cymbal with every note in a bass line.

Next are the alternating note maps, which let you divide the keyboard in some unique ways. If you are using two or more MIDI devices (including the Forte), you can expand polyphony by assigning each zone to a different alternating note map. For example, if you have two Fortes, you can assign two zones to each play the same program on a different Forte, thereby doubling polyphony.

To split a zone into one of two alternating note maps, set Note Map to 1 of 2; now the zone plays on every second key, starting on C, but won't play on any other keys. Set another zone to 2 of 2, and this zone will play on every second key, starting on C#, thus covering the remaining keys. Three and four-zone alternating notemaps work the same way, but cause each zone to play only on every third and every fourth key, respectively.

## Destination

The Destination parameter determines whether MIDI data generated by the keyboard and physical controllers of the currently selected Zone is sent to a Forte Program, through the MIDI Out/USB ports, or all three. You can set this parameter to any of the eight combinations for the three destinations for this parameter:

Note that this parameter works in conjunction with the Global parameter of the same name (see page 10-13) and both are active. They act like filters, so if one is set to MIDI, and the other is set to Local + MIDI, transmission will be limited to MIDI only.



**CAUTION:** It is possible to stop all MIDI transmission, in Multi Mode, if one Destination parameter is set to Local, and the other is set to MIDI.

Setting	MIDI Out	USB	FORTE
NONE			
LOCAL			Yes
MIDI	Yes		
MIDI + LOCAL	Yes		Yes
USB		Yes	
USB + LOCAL		Yes	Yes
USB + MIDI	Yes	Yes	
USB + LOCAL + MIDI	Yes	Yes	Yes

**NONE**

Unused Zones are set to None to avoid transmitting MIDI on these zones. The Zone will still be able to receive incoming MIDI.

**LOCAL**

When Destination is set to LOCAL, MIDI data from the Zone is sent only to the Forte Program. MIDI data from this Zone is not sent to the MIDI Out or USB ports.

**MIDI**

When Destination is set to MIDI, MIDI data from the Zone is sent only to the MIDI Out ports. MIDI data is not sent to a Forte Program or the USB ports from this Zone.

**MIDI + LOCAL**

When Destination is set to MIDI+LOCAL, MIDI data from the Zone is sent to a Forte Program and to the MIDI Out ports.

**USB**

When Destination is set to USB, MIDI data from the Zone is sent only to the USB ports.

**USB + LOCAL**

When Destination is set to USB+LOCAL, MIDI data from the Zone is sent to a Forte Program and to the USB ports.

**USB + MIDI**

When Destination is set to USB+MIDI, MIDI data from the Zone is sent to the USB & MIDI Out ports only. MIDI data is not sent to a Forte Program on this Zone.

**USB + LOCAL + MIDI**

When Destination is set to USB+LOCAL +MIDI, MIDI data from the Zone is sent to the USB & MIDI Out ports, as well as the Forte Program on this Zone.

## Out

Use the Out parameter to set the rear panel audio outputs used for each zone of the current Multi. This parameter determines the output settings for the main program signal and insert effects of each zone

A setting of Auto will make that zone output audio based on the settings for the program used by that zone. Program output settings are set in the Program Editor using the Output parameter on the FX page.

A setting of A will output Zone audio to the “A” Balanced Analog Outputs.

A setting of B will output Zone audio to the “B” Balanced Analog Outputs.

## Channel

The Channel parameter determines the MIDI transmit and receive channel for the currently selected Zone. You can set this parameter to any of the 16 MIDI channels (1-16).

You can assign different Zones to the same channel, but only one Program can be loaded in a channel at a particular time. The Program loaded will be whichever program change message is received last.

## BankMode

The Bank Mode parameter determines the controller number with which MIDI Bank change messages are transmitted. For MIDI Bank change messages, various manufacturers have chosen different MIDI controller numbers. Most have chosen 0, 32, or both. In the case of the Kurzweil K2600, it responds to controller 32, but is limited to 100 programs per bank.

You can set this parameter to any of the following:

<b>None</b>	MIDI Bank change messages are disabled.
<b>Ctl0</b>	MIDI Bank change messages are sent with controller number 0.
<b>Ctl32</b>	MIDI Bank change messages are sent with controller number 32.
<b>Ctl0/32</b>	MIDI Bank change messages are sent with both controller numbers 0 and 32.
<b>K2600</b>	MIDI Bank change messages are sent with controller number 32. (K2600 Program numbers 0-99.)

#### MidiBank

The MIDI Bank parameter determines the MIDI Bank change message that the currently selected Zone sends when the Multi is loaded. You can set this parameter to a MIDI Bank change message from 0 to 16383.

When using the Forte as a MIDI controller, sending a MIDI Bank change message (along with a MIDI Program change message) when a Multi is loaded ensures that the Program loaded on the other sound modules in your MIDI chain is the Program that you want.

For example, if you've configured a Multi to work in a specific way with Program 32 in Bank 5 of a connected sound module, then set MIDI Bank to 5 and MIDI Program to 32. This way, whenever you load this Multi, the sound module will automatically load Program 32 in Bank 5. Pressing both Previous & Next buttons simultaneously will set this parameter to the Bank number of the currently selected Local Program.



**NOTE : When you change the Program parameter, the MIDI Bank and MIDI Program parameters will automatically change to match the Bank and Program numbers of the Program that you select for Local Program. For example, if you choose Program 178, then MIDI Bank will change to 1 and MIDI Program will change to 50.**

#### MidiProg

The MIDI Program parameter determines the MIDI Program change message that the currently selected Zone sends when the Multi is loaded. You can set this parameter to a MIDI Program change message from 0 to 127.

When using the Forte as a MIDI controller, sending a MIDI Program change message (along with a MIDI bank change message) when a Multi is loaded ensures that the Program loaded on the other sound modules in your MIDI chain is the Program that you want. For example, if you've configured a Multi to work in a specific way with Program 32 in Bank 5 of a connected sound module, then set MIDI Bank to 5 and MIDI Program to 32. This way, whenever you load this Multi, the sound module will automatically load Program 32 in Bank 5.



**NOTE : When you change the Program parameter, the MIDI Bank and MIDI Program parameters will automatically change to match the Bank and Program numbers of the Program that you select for Local Program. For example, if you choose Program 178, then MIDI Bank will change to 1 and MIDI Program will change to 50.**

## **EntryPrgChg**

The Entry Program Change parameter determines whether or not the currently selected Zone will send a MIDI Program change message when the Multi is loaded. You can set this parameter to either Off or On. When set to On, the Zone will send a MIDI Program change message with the Program specified for the MIDI Program parameter.

## **Bend Up / Down ST & Bend Up / Down CT**

Bend Up ST and Bend Down ST sends a bend range message to an internal program or a MIDI device, telling it how to define subsequent pitch bend messages. You can set this parameter to any value between 0 semitones and 127 semitones, or to Prog, which uses the Bend Range Up / Down of the currently selected Program for the Zone. The value can be entered numerically, and entering -1 will select Prog. (value that the Program would use in Program Mode).

Bend Up CT and Bend Down CT lets you fine tune the value for Bend Up ST & Bend Down ST (semitones). 100 cents equals one semitone, or one half step; you can set this parameter anywhere between 0 and 100 cents.

## **VelMode**

The Velocity Mode parameter determines the method that the Forte maps the keyboard's strike velocity to MIDI velocity. Set to "Traditional" the keyboards velocity will translate to a MIDI velocity depending how hard you strike it. With a setting of "Fixed", the velocity is set to a pre-determined value regardless of how hard or soft the keyboard is played.

A setting of "Fixed" will remove some of the other Velocity settings in the MAIN page and replace it with a parameter called Velocity that has range of values from 0 to 127.

## **VelScale**

The Velocity Scale parameter lets you amplify or diminish velocity response from -300% to 300%. Normal response is 100%. Higher values make the keyboard more sensitive (you don't need to play as hard to get higher MIDI velocities) while lower values make it less sensitive (playing harder doesn't change MIDI velocity as much). You can also set the scale to a negative number, in which case the velocity response is turned upside-down: playing harder produces a softer sound and vice versa. This is useful for creating velocity-based crossfades between zones.

See the following section on VelOffset for ideas about negative scaling.

## **VelOffset**

The Velocity Offset parameter also changes the velocity response, but in a more direct way, by adding or subtracting a constant to the key velocity.

For example, if this is set to 25 (assuming a scale of 100%), then 25 is added to the velocity of every keystroke, usually making the sound that much louder. The softest possible keystroke will have a value of 25, while a keystroke with velocity of 102 will produce the same sound as a note with velocity 127 ( $102+25=127$ ). Negative values diminish the response: a setting of -25 means the loudest velocity available will be 102, while any keystroke 25 or below will produce a velocity of 1 (a velocity value of zero has a special meaning in MIDI and cannot be used for Note Ons).

You can think of Scale as being a proportional change to the velocity, while Offset is a linear change. The maximum values for Offset are  $\pm 127$ .

Offset and Scale work together. If scaling takes the velocity out of the ballpark — for example, you want to set it to 300% but that puts all of your notes at maximum velocity — using a negative offset, say around -60, can make it possible to still play at different volumes, although your curve will still be a lot steeper than normal. If you use a negative scaling, then you must use an offset: otherwise all of your velocities will end up as zeroes (well, ones actually, since a MIDI note-on with velocity zero is interpreted by some modules as a note-off message). So to get true inverse scaling (that is, minus 100%), you must set an offset of 127 to get the full range of velocities. Setting the offset to 127 and the scale to -100% (which is the same as the reverse linear curve):



**NOTE : That Offset and Scale affect only MIDI velocities; that is, these parameters don't change Velocity Tracking in the programs themselves. Therefore, some programs (such as organ sounds, which often have low VelTrk values) may respond only subtly to Offset and Scale, or not at all.**

### VelCurve

The Velocity Curve parameter lets you taper the velocity response. The default setting is **Linear**, which means that the output velocity changes directly proportionally to the played velocity.

**Expand** produces a curve that is less steep than the linear curve at keystrike velocities below 64, and steeper than the linear curve at keystrike velocities above 64. In other words, when you're playing softly, you'll notice velocity differences less than with a linear curve, while when you're playing hard, you'll notice velocity differences more.

**Compress** produces a velocity curve that is the opposite of the expanded curve—that is, you'll notice velocity differences more when you're playing softly than when you're playing hard.

**Crossfade** is designed to be used in tandem with the Reverse Crossfade curve, enabling you to perform smooth crossfades between different programs.

**Bump** tapers velocity response to resemble a bell curve, so that notes are loudest when your keystroke velocity is 64. Notes get softer as the keystroke velocity approaches 0 or 127.

The next four velocity curves are Reverse Linear (**Rvrs Linear**), Reverse Expand (**Rvrs Expand**), Reverse Compress (**Rvrs Compress**), and Reverse Crossfade (**Rvrs Crossfade**). These taper velocity in reverse of the five curves we just covered. For example, Reverse Linear's response is such that striking a key harder will produce a lower volume, striking it softer will produce a higher volume, and so on. This provides a convenient way to achieve negative scaling, by letting you set one parameter instead of two.

### **LoVel, HiVel**

LoVel (Low Velocity) and HiVel (High Velocity) set the minimum and maximum velocity limits that the current zone transmits.

A keystroke in the current zone whose velocity — *after* it has been scaled and offset — is below the minimum does not generate a Note On. Neither does a keystroke whose velocity after processing is above the maximum. These parameters are useful for “velocity switching”—having a key play different sounds depending on how hard you strike it.

The values can be anywhere from 1 to 127. As with other parameters, zones can overlap or be totally discrete, or be identical. Usually, LoVel will have a smaller value than HiVel, but as with LoKey and HiKey, you may also create a gap in velocity response, by setting HiVel to a lower value than LoVel.

# CONTROLS Page

Press the CONTROLS soft button to view pages where you can set parameters for each of the Forte physical controllers. Broadly speaking the Forte has switch controllers (such as buttons and Foot Switches), and continuous controllers (such as the wheels, sliders and foot controllers). Switch and continuous controllers have different parameters available to them on the Controls page, which are described below.

## Switch Controllers

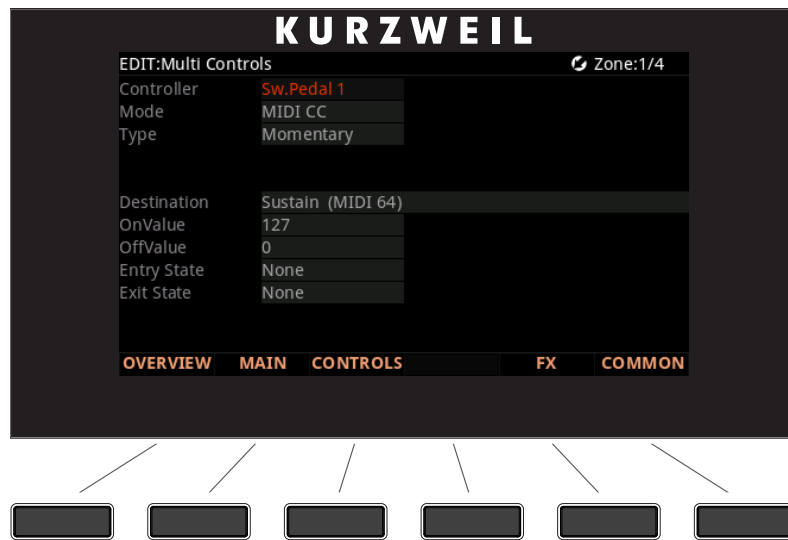

Parameter	Range Of Values
Controller	See Controller List
Mode	Off, MIDI CC, Chord (Chord is only available for Switch Controllers)
Type	Momentary, Toggled
Destination	See Multi Destination Control List
OnValue	None, 0 to 127
OffValue	None, 0 to 127
Entry State	None, Off, On
Exit State	None, Off, On
Velocity	Auto, 1 to 127
Key1....Key8	None, C-1 to G9

You can select any of the Forte’s physical controllers by moving the cursor to the “Controller” parameter, and using either the Alpha Wheel or Value buttons to scroll the list. Alternatively, you can also position the cursor in the “Controller” parameter, hold down the Enter button and move the controller you wish to edit.

## Controller

The Controller parameter allows you to assign any of the Forte's physical controllers (sliders, switches, mod and pitch wheels, foot switches and expression pedals) to control a program specific parameter or MIDI controller number for the currently selected zone.

First, use the Channel /Zone buttons to the left of the display to select the desired zone that you wish to assign a controller for. Next, on the CONTROLS page, use the cursor buttons to select the "Controller" field, hold the Enter button on the alphanumeric pad and then move any of the Forte's physical controllers. This will select that controller and display its available parameters. (You can also scroll through the list of controllers in the Control page by selecting the Controller field with the cursor buttons and using the Alpha Wheel or the Value buttons to scroll through the list.)

If a pedal is selected which has a pedal override enabled in Global mode, a message "Global Pedal Override is enabled" will display when that pedal is viewed to remind you that the Global mode pedal override settings are being used instead of the Multi mode pedal settings.

<b>FORTE SWITCH CONTROLLERS</b>	
<b>Sw. Pedal 1</b>	<b>Switch 1</b>
<b>Sw. Pedal 2</b>	<b>Switch 2</b>
<b>Sw. Pedal 3</b>	<b>Switch 3</b>
<b>Variation</b>	<b>Switch 4</b>
<b>Key1-Key12</b>	<b>Switch 5</b>

Select a Switch controller from the list above; the Switch controller parameters are described below.

## Mode

Switch Controllers have three modes: Off, MIDI CC, or Chord.

With a value of Off, the controller is disabled for this zone.

With a value of MIDI CC, the controller has the ability to transmit MIDI control messages.

Switch controls can also be set to Chord mode. In Chord mode, the switch can play a chord containing up to 8 notes.

## Multi Edit Mode

### CONTROLS Page



### Type

The Type parameter determines the switching behavior of Foot Switches and buttons. This is a Common parameter that affects all Zones.

<b>Momentary</b>	A momentary switch is one that is only in the “on” state when it is pressed. As soon as you release the switch, it goes into the “off” state.
<b>Toggled</b>	A toggled switch is one that maintains its state after it is pressed. So, if the switch is currently in the “off” state, pressing it once will put it in the “on” state. Pressing it again will put it back in the “off” state.

### On Value

The On Value is the MIDI value sent when a switch controller is set to On. You can set this parameter to any number between 0 and 127, or to None.

### Off Value

The Off Value is the MIDI value sent when a switch controller is set to Off. You can set this parameter to any number between 0 and 127, or to None.

### Entry State

The Entry State parameter determines the state of the Foot Switch or button that is sent as a MIDI message when the current Multi is loaded. You can set this parameter to None, On, or Off. This parameter is common to all Zones.

None can be entered with the alphanumeric function of the Category buttons as -1.

If Entry State is set to None, then when you load the current Multi, no value will be transmitted. If you specify an Entry State, then a MIDI controller message with this value will be sent when you load the current Multi.

### **Exit State**

The Exit State parameter determines the state of the Foot Switch or button that is sent as a MIDI message when the current Multi is exited. You can set this parameter to None, On, or Off. This parameter is common to all Zones.

None is entered with the alphanumeric function of the Category buttons as -1.

If Exit State is set to None, then when you leave the current Multi by selecting another Multi or Program, the Foot Switch or button will remain at whatever value corresponds to its current position. If you specify an Exit State, then a MIDI controller message with this value will be sent when you select a different Multi or Program.

### **Velocity**

The Velocity parameter only appears if the Mode is set to “Chord” and is for use with switch controllers. Use the Velocity parameter to select a MIDI attack velocity (0-127) for the note(s) designated in the Key1 to Key8 field(s.) Alternatively, set the Velocity field to Auto and the note’s velocity will be the velocity set by the KeyVel Multi Destination (see KeyVel on page 9-24).

### **Key1.....Key8**

The Key1, Key2, Key3, Key4, Key5, Key6, Key7, Key8 parameters are available when the Mode is set to “Chord” . Use the Key(1 to 8) parameters to select the note to be played. The note is displayed by MIDI note name.

To select a note, select the KeyNum field with the cursor buttons, hold the Enter button on the alphanumeric pad, then play the desired note on the keyboard. You can also change the note in the field by using the Alpha Wheel or -/+ buttons.

### **Key**

When the Controller parameter is set to a Key (Key1-Key12) and Mode is set to something other than “Off”, the Key parameter appears. Use the Key parameter to select which of the Forte’s Keys you wish to use as a switch controller. With the Key parameter selected, you can set a key by holding the Enter button and striking the desired key.

## Multi Edit Mode

### CONTROLS Page

#### Do

When the Controller parameter is set to a Key (Key1-Key12) and Mode is set to something other than “Off,” the Do parameter appears. The Do parameter determines whether the key will play a note and perform a switch function, or whether the key will only perform a switch function. Set the Do parameter to “Both” to play a note and perform a switch function, or set it to “OnlySw” to only perform a switch function.

#### Destination

Use the Destination parameter to assign the Forte physical controllers (Sliders, Pedals, Switches, Mod Wheel, etc.) to control Program parameters or send MIDI continuous controller messages (CCs) to external MIDI gear. If a CC number is assigned to a parameter in the Program of the current Zone, the parameter name will be listed in the Destination list in place of that CC number.

The Destination parameter determines the MIDI CC controller number that a physical controller will send to the Program in the currently selected Zone. By default, these CC messages are also sent to the MIDI Out and USB ports on the Channel of that Zone.

The list of CC controller numbers below (see page 9-24) shows the default assignments for each destination. Programs respond to some of these CCs for standard MIDI functions like volume and panning. Other external MIDI gear (sound modules, computer software) may respond to standard MIDI CC messages as well. Standard MIDI CC’s range from 0-127 and can be received by the Forte from external devices, while destinations 128-146 are internal to the Forte only.

## Continuous Controllers

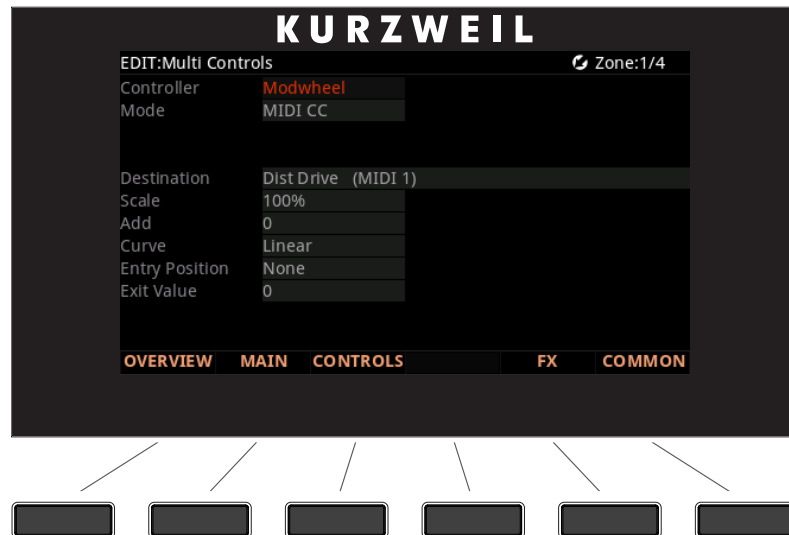

Parameter	Range Of Values	Default Value
Controller	See Controller List	-
Mode	Off, MIDI CC	-
Destination	See Multi Destination Control List	-
Scale	-300% to +300%	100%
Add	-128 to 127	0
Curve	Linear, Compress, Expand, Cross-fade, Bump, Rvrs Linear, Rvrs Expand, Rvrs Compress, Rvrs Crossfade	Linear
Entry Position	None, 0 to 127	-
Exit Value	None, 0 to 127	-

### Controller

The Controller parameter allows you to assign any of the Forte’s physical controllers (sliders, switches, mod and pitch wheels, foot switches and expression pedals) to control a program specific parameter or MIDI controller number for the currently selected zone.

First, use the Channel /Zone buttons to the left of the display to select the desired zone that you wish to assign a controller for. Next, on the CONTROLS page, use the cursor buttons to select the “Controller” field, hold the Enter button on the alphanumeric pad and then move any of the Forte’s physical controllers. This will select that controller and display its available parameters. (You can also scroll through the list of controllers on the Control page by selecting the Controller field with the cursor buttons and using the Alpha Wheel or the Value buttons to scroll through the list.) If a pedal is selected which has a pedal override enabled in Global mode, a message “Global Pedal Override is enabled” will display when that pedal is viewed to remind you that the Global mode pedal override settings are being used instead of the Multi mode pedal settings.

<b>FORTE CONTINUOUS CONTROLLERS</b>	
<b>Mod Wheel</b>	<b>Slider A</b>
<b>PitchUp</b>	<b>Slider B</b>
<b>PitchDown</b>	<b>Slider C</b>
<b>CC Pedal 1</b>	<b>Slider D</b>
<b>CC Pedal 2</b>	<b>Slider E</b>
<b>Pressure</b>	<b>Slider F</b>
	<b>Slider G</b>
	<b>Slider H</b>
	<b>Slider I</b>

Select a Continuous controller from the list above, the Continuous controller parameters are described below.

#### Mode

Continuous Controllers have two modes: Off, or MIDI CC.

With a value of Off, the controller is disabled for this zone.

With a value of MIDI CC, the controller has the ability to transmit MIDI control messages.

#### Scale

After you've selected a continuous physical controller, you can modify the controller's response in a similar way that you can modify velocity response.

Scale lets you amplify or diminish the action of the controller. Full scale is 100%. Higher values will make the controller more sensitive, and lower values will make it less so. Setting the scale to a negative number makes the controller action work in reverse. As with velocity, you can use a controller to crossfade between two zones by setting the scaling for one zone positive and the other negative. Maximum scale values are +300% and -300%.

#### Add

This adds or subtracts a constant to the controller, and at the same time sets minimum or maximum values. If Add is 25, the minimum value of the controller will be 25. If it is -25 (and scale is 100%) the first one-fifth of the controller's movement ( $25/127 \approx 1/5$ ) will send a value of 0, and the maximum value of the controller will be 102 (=  $127-25$ ). As with velocity, Scale is a proportional change to the controller, while Add is a linear change. The values for Add range from -128 to 127.

#### Curve

The Curve parameter lets you taper the velocity response. The default setting is **Linear**, which means that the output velocity changes directly proportionally to the played velocity.

**Expand** produces a curve that is less steep than the linear curve at keystrike velocities below 64, and steeper than the linear curve at keystrike velocities above 64. In other words, when you're playing softly, you'll notice velocity differences less than with a linear curve, while when you're playing hard, you'll notice velocity differences more.

**Compress** produces a velocity curve that is the opposite of the expanded curve—that is, you'll notice velocity differences more when you're playing softly than when you're playing hard.

**Crossfade** is designed to be used in tandem with the Reverse Crossfade curve, enabling you to perform smooth crossfades between different programs.

**Bump** tapers velocity response to resemble a bell curve, so that notes are loudest when your keystrike velocity is 64. Notes get softer as the keystrike velocity approaches 0 or 127.

The next four velocity curves are Reverse Linear (**Rvrs Linear**), Reverse Expand (**Rvrs Expand**), Reverse Compress (**Rvrs Compress**), and Reverse Crossfade (**Rvrs Crossfade**). These taper velocity in reverse of the five curves we just covered. For example, Reverse Linear's response is such that striking a key harder will produce a lower volume, striking it softer will produce a higher volume, and so on. This provides a convenient way to achieve negative scaling, by letting you set one parameter instead of two.

### **Entry Position**

The Entry Position value allows you to specify an initial value for a controller in a setup that will be sent whenever you select that Multi. For example, if you want to make sure that all of the modulation in a zone is turned off when you select a Multi, assign a physical controller to a destination of MIDI 01 (MWheel) and set Entry Value to 0.

Entry Position refers to the position of the physical controller. For Sliders the Entry Position is indicated by the LED Ladder along side the Slider. The Entry Position is common to all Zones, however the Curve, Scale and Add modifiers are applied to the Entry Position (and the controller value) individually on each zone, allowing the one controller to send different values to the assigned destinations on different zones, if desired.

Entry Position ignores the current position of the physical controller when the Multi is selected. In fact, if the Multi Controllers parameter in Global Mode (see page 10-6) is set to Pass Entry, and the physical controller is above or below the entry value when the Multi is selected (which it often is), moving the controller will have no effect until it is past the entry value. In the modulation example above, moving the assigned controller won't turn on any modulation until it's pushed all the way down, and then up again.

If the Multi Controllers parameter is set to Instant, any movement of the physical controller will immediately be assigned to the controller. This may cause an abrupt change in the sound.

An Entry Position of None is quite different from a value of 0. None means that there will be no initial controller command when the Multi is selected, and any subsequent movement of the physical controller will be effective.

### **Exit Value**

The Exit Value tells the Forte to send a value for that controller whenever you leave the Multi, either by selecting another Multi or by selecting a different mode altogether. It can be very useful when a controller is doing something to the sound, and you don't want that effect to continue after you leave the Multi.

For example, if you want to make sure a zone's modulation wheel returns to normal whenever you leave a Multi, you would set Exit Value to 0.

A setting of None means no command is sent. The Exit Value is not common to all Zones and can be set individually on each Zone, for each controller.

## Multi Edit Mode

### CONTROLS Page

#### Destination

Use the Destination parameter to assign the Forte physical controllers (Sliders, Pedals, Switches, Mod Wheel, etc.) to control Program parameters or send MIDI continuous controller messages (CCs) to external MIDI gear. If a CC number is assigned to a parameter in the Program of the current Zone, the parameter name will be listed in the Destination list in place of that CC number.

The Destination parameter determines the MIDI CC controller number that a physical controller will send to the Program in the currently selected Zone. By default, these CC messages are also sent to the MIDI Out and USB ports on the Channel of that Zone.

The list of CC controller numbers below shows the default assignments for each destination. Programs respond to some of these CCs for standard MIDI functions like volume and panning. Other external MIDI gear (sound modules, computer software) may respond to standard MIDI CC messages as well.

#### **Controlling Program Parameter Assignments from Multi Mode**

Commonly you will want to assign a physical controller in a Multi to control the same Program parameter that it controlled in Program Mode. In the Destination parameter list, destinations that are assigned to parameters for the Program of the current Zone will show the Program Parameter name in place of the standard Controller Destination name. Select one of these destinations to control an assigned Program parameter.

Controller Number	Controller Destination	Description
0	OFF/Bank	By default, when you enter 0 or Clear for the Destination parameter, the destination will be assigned to OFF. To select Bank as the destination, use the Value buttons.
1	MWheel	Default destination for the Modulation Wheel
2	Breath	Default assignment for breath controller in compatible synths
3	MIDI 03	MIDI Controller 3
4	Foot	Default assignment for continuous foot controller in compatible synths
5	PortTim	Monophonic Forte Programs respond to this Controller if portamento is turned on.
6	Data	MIDI Controller 6
7	Volume	MIDI Volume
8	Balance	MIDI Balance
9	MIDI 09	MIDI Controller 9
10	Pan	MIDI Pan
11	Express	Default assignment for CC Pedal. In most Programs it acts as a volume control. It scales between 0 and the current value of Volume.
12	MIDI 12	Default assignment for Slider A
13	MIDI 13	Default assignment for Slider B
14-21	MIDI 14-21	MIDI Controllers 14-21
22	MIDI 22	Default assignment for Slider C
23	MIDI 23	Default assignment for Slider D
24	MIDI 24	Default assignment for Slider E
25	MIDI 25	Default assignment for Slider F
26	MIDI 26	Default assignment for Slider G

Controller Number	Controller Destination	Description
27	MIDI 27	Default assignment for Slider H
28	MIDI 28	Default assignment for Slider I
29	MIDI 29	Default assignment for Variation switch
30-31	MIDI 30-31	MIDI Controllers 30–31
32	MIDI Bank	MIDI Bank change message
33–63	MIDI 33–63	MIDI Controllers 33–63
64	Sustain	Default destination for Sustain Pedal
65	MIDI 65	
66	Sostenuto	Default destination for Sostenuto Pedal (Sustains notes that are currently down, but not notes played subsequently.)
67	Soft	Lowers the volume by a preset amount and may soften the timbre as well.
68	Legato	Forces mono playback.
69	Freeze	Envelopes freeze at current state.
70–79	MIDI 70–79	MIDI Controllers 70–79
80	MIDI 80	Default assignment for Switch 1 (Zone 1 Switch)
81	MIDI 81	Default assignment for Switch 2 (Zone 2 Switch)
82	MIDI 82	Default assignment for Switch 3 (Zone 3 Switch)
83	MIDI 83	Default assignment for Switch 4 (Zone 4 Switch)
84	Portamento	Standard MIDI controller for setting Portamento starting note
85	MIDI 85	Default assignment for Switch 5 (Assignable Switch 1)
86	MIDI 86	Default assignment for Switch 6 (Assignable Switch 2)
87	MIDI 87	Default assignment for Switch 7 (Assignable Switch 3)
88	MIDI 88	
89	MIDI 89	Default assignment for Switch 8 (Assignable Switch 4)
90	MIDI 90	Default assignment for Switch 9 (Assignable Switch 5)
91–95	MIDI 91–95	MIDI Controllers 94–95
96	Data Inc	Equivalent to pressing the Next Value button
97	Data Dec	Equivalent to pressing the Previous Value button
98	NRegParL	Non-Registered Parameter Least Significant Byte
99	NRegParM	Non-Registered Parameter Most Significant Byte
100	RegParL	Registered Parameter Least Significant Byte
101	RegParM	Registered Parameter Most Significant Byte
102–109	MIDI 102–109	MIDI Controllers 102–109
110-119	MIDI 110–119	Reserved - Not available for use in the Forte.
120	Sound Off	Stops all sound in the corresponding channel.
121	RstCtls	Resets Controllers to defaults in the corresponding channel.
122	Local	
123	Notes Off	Sends Note Off Message to all playing notes in the corresponding channel.
124	Poly	
125	Omni	
126	Mono On	
127	Mono Off	
128	Pitch	Values above 64 and below 64 bend the pitch up and down, respectively.
129	PitchRev	Values above 64 and below 64 bend the pitch down and up, respectively

## Multi Edit Mode

### CONTROLS Page

Controller Number	Controller Destination	Description
130	PitchUp	Values above 0 bend the pitch up
131	PitchDwn	Values above 0 bend the pitch down
132	Pressure	Default Destination for Pressure
133	Tempo	Tempo
134	KeyNum	Triggers playback of notes by Key Number—e.g., C4 is 60. Send a velocity first with Destination135, KeyVel.
135	KeyVel	Key Velocity
136	ProgInc	Program Increment—increments current Program number.
137	ProgDec	Program Decrement—decrements current Program number.
138	ProgGoto	Go to Program—selects Program.
139	MultiInc	Multi Increment—increments current Multi number.
140	MultiDec	Multi Decrement—decrements current Multi number.
141	SetpGoto	Go to Multi—selects Multi.
145	TransUp	Transpose Up (ST)
146	TransDown	Transpose Down (ST)
149	MuteZn	Mute Zone – Values above 64 will mute the zone that sends values to this destination, values below or equal to 64 will unmute the zone.
161	Panic	Sends an “all notes off” message and an “reset all controllers” message on all 16 MIDI channels.
162	SoloZn	Solo Zone - Values above 64 will solo the zone that sends values to this destination, values below or equal to 64 will unsolo the zone. When a zone is soloed, the Zone Mute button LED for the soloed Zone will turn red. All other Zones will be muted and their Zone Mute button LEDs will turn orange. Pressing any muted/orange Zone buttons will make that Zone the soloed zone. Pressing the soloed zone button will cancel solo mode. To return to Solo mode the original controller assigned to Solo Zone (162) will need to be re-engaged.

## FX Page

The Forte contains Kurzweil's acclaimed effects processor, and when combined with Multi Mode it puts the power of an entire studio of audio effects at your fingertips. This section contains everything you'll need to know in order to use the Forte's effects in Multi Mode.

Press the FX soft button to enter the FX page.

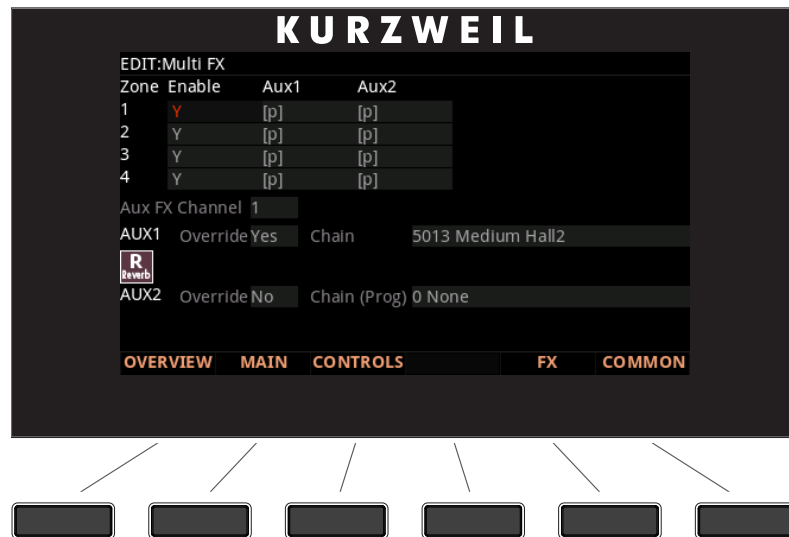

Parameter	Range Of Values	Default Value
Enable	Y, N, (Y)	Y
AUX1	[p], 0 to 127	[p]
AUX2	[p], 0 to 127	[p]
Aux FX Channel	1 to 16	1
AUX1 Override	Yes, No	[p]
AUX2 Override	Yes, No	No
Chain	Effects List (Appendix F)	No

### Enable

Use the Enable parameter to enable or disable the Insert effects Chain of the Program in each Zone. Each Zone can be set to **Y** to enable Insert effects, or to **N** to disable Insert effects. Use the Alpha Wheel or Value buttons to change between **Y** and **N**. Some Zones set to **Y** may be displayed as **(Y)**. This means that there are not enough effects resources available for that Zone, and that Zone's Insert effects are not loaded. If you want to use the Insert effects Chain for a Zone displayed as **(Y)**, try setting other Zones to **N**.

#### **Aux FX Channel**

The Aux FX Channel determines the FX channel through which the aux sends of all of the zones in the current Multi are sent. For example, if a zone 2 in a Multi has a program with 25 Basic Delay 1/8 as an Aux FX, and zone 2 is assigned to channel 5, then setting the Aux FX Channel to 5 sends the programs of all of the zones in the Multi through zone 2's Program's Aux FX (i.e., through 25 Basic Delay 1/8).

#### **AUX1, AUX2**

The setting for the AUX1 (Auxiliary 1) & AUX2 (Auxiliary 2) parameters determines if the auxiliary send level for the selected Zone program is overridden, and if so, by what value. The two Auxiliary effects busses are global to all zones/channels on the Forte. The default value of [p] means "no override" (i.e., use the values specified in the program.) To override the send level value, select the AUX1 or AUX 2 send level parameter for the desired Zone, and enter a new value with the Alpha Wheel, +/- buttons, or enter a value with alphanumeric pad and press the Enter button.

#### **AUX1 Override, AUX2 Override**

Normally, the Aux Effects Chains are specified by the program on the specified Aux Effects channel. When Override is set to Yes, the Chain parameter can be selected, allowing you to choose a different Aux effect Chain.

Set Override to Yes to select an override Aux Chain on this page. Set Override to No to use the Aux FX chain of the specified Aux FX Channel.

#### **Chain**

When AUX1 Override or AUX2 Override is set to Yes, you can select an override Aux Chain for the corresponding Aux Effect. The Chain parameter can not be selected when Override is set to No, and "(Prog)" is shown as a reminder that the Chain from the Program on the Aux FX Channel is being used. (See Appendix F Effects on page F-1 for a full list of available Effect Chains).

## COMMON Page

The COMMON page contains parameters that affect every zone in the current Multi.

Press the COMMON soft button to enter the COMMON page.

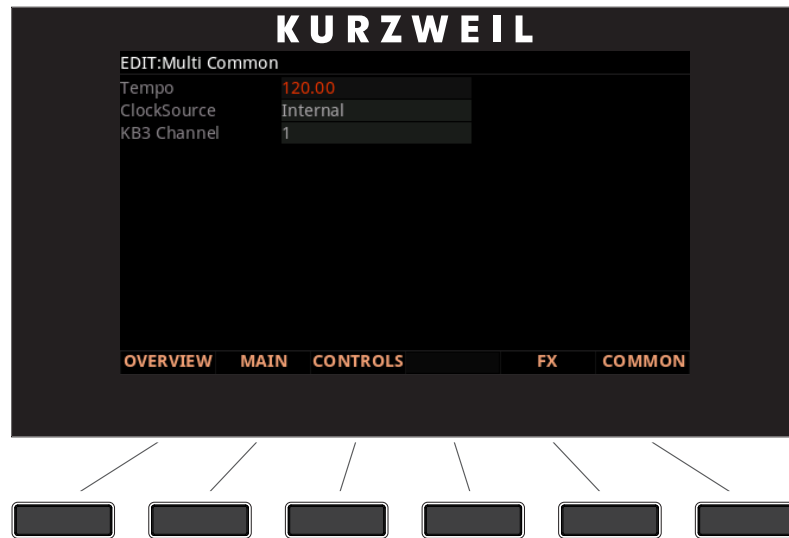

Parameter	Range Of Values	Default Value
Tempo	20 to 400 BPM	120
Clock Source	Internal, External	Internal
KB3 Channel	1 to 16	1

### Tempo

When Clock Source (see Global Mode MAIN1 page) is set to Internal, the Tempo parameter sets the Forte's system tempo for this Multi. The Tempo parameter values are in units of BPM (beats per minute). This controls the tempo of any tempo based effects.

You can also set the tempo using the Tap Tempo button (located on the front panel above the Pitch Bend Wheel.) Tap the Tap Tempo button on beat for a measure or two at the desired tempo to set a tempo. This also brings up the Tap Tempo page (see Tap Tempo Button on page 3-7).

### Clock Source

With the Clock Source parameter, you can set the Forte—within the current Multi—to generate its own tempo by setting Clock Source to Internal, or you can set the Forte to sync up with the tempo from another device—assuming the device is sending MIDI clock data to the Forte via MIDI or USB—by setting Clock Source to External. When Clock Source is set to External, the Tempo parameter disappears from the display.

## Multi Edit Mode

### About Auxiliary Effects

#### KB3 Channel

If KB3 Programs are selected for more than one Zone, this parameter specifies which MIDI Channel has priority to load a KB3 Program. Only one KB3 Program can be loaded at a time. You can set this parameter to a value between 1 and 16. If you want a KB3 Program to play in a zone, you should set the KB3 channel to the channel of the Zone.

## About Auxiliary Effects

Programs and Multis both have an auxiliary effect send. An auxiliary effect is an effect that is not in the direct path of the sound, but rather, it “receives” and processes the sound applying the effect, which is mixed back with the original sound. The following diagram illustrates the signal path of a sound through the auxiliary effect: On the Forte, the auxiliary effects are global to all channels and Zones, Programs and Multi’s. One effect chain can be loaded into each of Aux1 and Aux2, and these are used for any Program or Multi that has active Aux Sends.

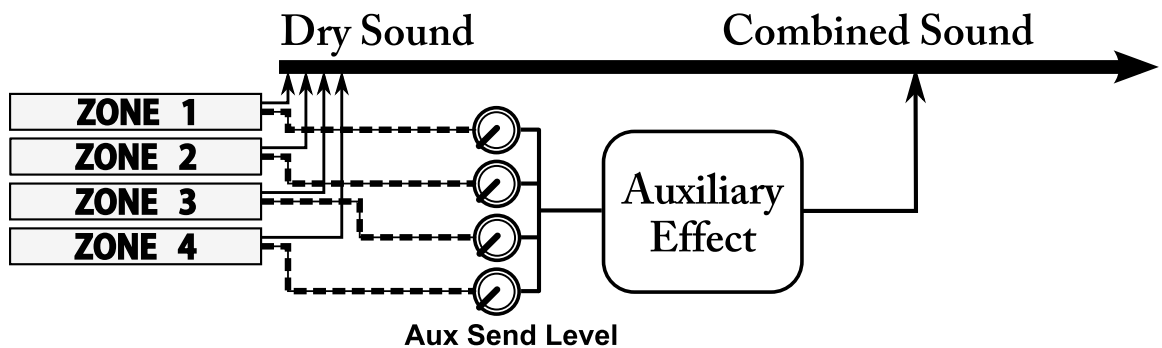

The AUX1 and AUX2 parameters (on the FX page) determines the level the auxiliary effect will process the sound for that Zone.

## Save and Delete User Multis

For details on saving user Multis, see Saving a User Multi on page 8-18 of the Multi Mode chapter.

For details on deleting user Multis, see DELETE Page on page 10-20.

# Chapter 10

## Global Mode

This chapter will help familiarize you with the features of Global Mode.

### About Global Mode

Global Mode gives you access to the global parameters of the Forte. It allows you to edit the master settings of the unit. It also allows you to restore factory defaults on the unit by performing a Reset.



**CAUTION: Performing a Reset will erase ALL User Programs, User Multis and reset Global settings to a factory state.**

To enter Global Mode from another Mode, press the Global Mode button.

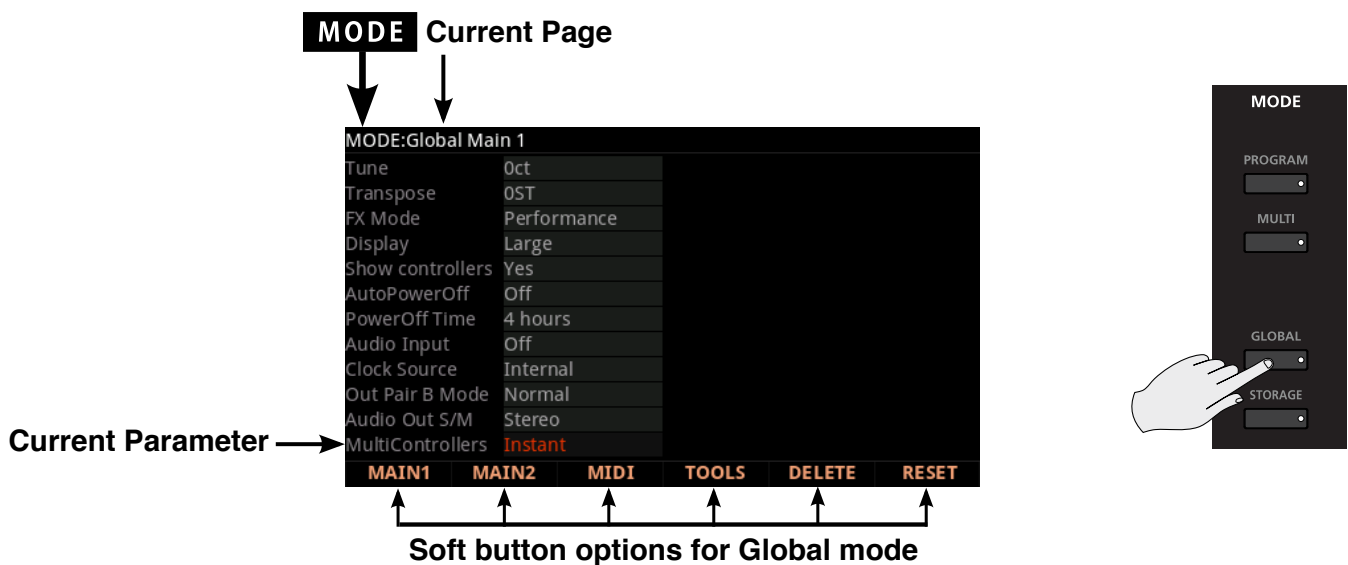

While you are in Global Mode, the Global button's indicator LED is lit.

## Global Mode

---

### Selecting and Editing Parameters

When you enter Global Mode, the last selected parameter since power-up (or the Tune parameter if you're entering Global Mode for the first time since power-up) will be the currently selected parameter.

## Selecting and Editing Parameters

To scroll through the parameters of Global Mode, use the Up/Down Arrow buttons.

First, using the buttons underneath the display, select the page you need.

To edit the currently selected parameter, use the Alpha Wheel or the Previous and Next buttons. Pressing both Previous & Next buttons simultaneously (called Value Jump) will jump to a different value depending on the parameter selected. The jump value is mentioned in each of the parameter descriptions below.

## MAIN1 Page

The MAIN1 page in Global Mode allows you to set up how effects are applied, tuning and the way things are displayed on the Forte LCD display.



Parameter	Range of Values	Default Value
Tune	-100 to 100 Cents (Ct)	Oct
Transpose	-128 to 127 Semitones (ST)	0ST
FX Mode	Performance, Multitrack	Performance
Display	Large, Favorites, List	Large
Show Controllers	Yes, No	Yes
Auto Power Off	On, Off	On
Power Off Time	15 & 30 mins, 1 hr, 2 hr, 4 hr, 8hr	4 hours
Audio Input	On, Off	Off
Clock Source	Internal, External	Internal
Out Pair B Mode	Normal, Mirror Out Pair A	Normal
Audio Out S/M	Stereo, Auto	Stereo
Multi Controllers	Instant, Pass Entry	Instant

### Tune

The Tuning parameter allows you to fine-tune the unit in cents—one cent is one hundredth of a semitone (100 cents comprise a semitone). You can select any tuning from -100 cents to 100 cents. By default this parameter is set to 0.

### Transpose

The Transpose parameter allows you to tune the pitch of the unit in semitones.

## FX Mode

The FX Mode parameter determines how the Forte responds to interrupts with regards to effects. You can set this parameter to either Performance or Multitrack.

With FX Mode set to Performance, the Forte minimizes disruption of existing effects when changing Programs, and entry values will not disrupt sustained notes when changing Programs in Program Mode. When controlling the Forte from an external sequencer in Program Mode, setting FX Mode to Multitrack will minimize effect disruption.

## Display

The Display parameter allows you to change the way that Programs and Multis are displayed on the Program and Multi Mode main pages by selecting one of three different “views”. The default is “Large” view, which displays the Program or Multi name with large text, along with the category name and background image. “Favorites” view is the same as Large view, plus the names of 10 favorite Programs and/or Multis are shown at the bottom of the display. “List” view displays the current Program or Multi as a selected item in a scrollable circular list that shows the next and previous Programs or Multis. “Large” and “Favorites” views can also show controller assignments and values when a controller is moved (Sliders, Switch buttons, Wheels, and Pedals). See “Show Controllers” below for details.

If Favorites view is selected and the Global Mode User Type parameter has been set to Advanced, you can use the Channel/Zone buttons in Program and Multi Mode to scroll through 16 banks of 10 Favorite Programs and/or Multis, allowing you to save and access 160 Favorites. With these settings, Program and Multi mode will show the current Favorites Bank number in the upper right hand corner of the screen instead of the current MIDI channel.

## Show Controllers

When “Large” or “Favorites” view is selected for the Display parameter (see above), the Program and Multi Mode main pages can briefly show controller assignments and values when a controller is moved (Sliders, Switch buttons, Wheels, and Pedals). Set this parameter to “Yes” to briefly show controller assignments when a controller is moved, or set it to “No” to hide controller assignments.

## Auto Power Off

The auto power off parameter turns the power saving feature on. When the Auto Power Off parameter is set to On, the Forte will automatically power off after the Power Off Time has expired, from the last key press (physical or MIDI), button press, controller movement, or USB MIDI activity.

## Power Off Time

If the Auto Power Off parameter is set to On, then the Forte will power off after the time selected by the Power Off Time parameter has elapsed. The Forte will display the following warnings before powering off. Press a key or move any Forte control to dismiss the warning message. After dismissing this message, the Forte will wait the selected amount of time before showing this warning again.



## Audio Input

If you have an MP3 audio player plugged into the Forte's rear "Audio In" jack, setting this to On will allow audio to be heard. This signal will be mixed with sounds normally generated by the Forte.

## Clock Source

With the Clock Source parameter set to Internal, Forte plays using its own Tempo. If you wish to sync the Forte to the tempo of an external device, use the External setting.

## Out Pair B Mode

The B Audio Outputs can either be used as a second set of stereo (auxiliary) outputs by setting this parameter to "Normal" or they can be used to mirror the main A Audio Outputs by setting this parameter to "Mirror Primary Outputs". By default this parameter is set to Normal.

## Audio Out S/M

The audio outputs are normally used as a stereo pair; however, on occasion the Forte might be operated in Mono mode by plugging an audio jack into the Left A Audio Output. Setting this parameter to Auto allows the Forte to detect the audio connections and adjust to mono output if required. The parameter can be set to Stereo, to force the Forte to output a stereo signal always and ignore the audio output detection. By default this parameter is set to Auto.

## **Multi Controllers**

When a multi is selected, this parameter determines how the sliders respond to movement. When set to instant, moving a slider will result in the assigned parameter immediately jumping to the slider position. With some parameters an abrupt change to the sound may be undesirable. In this case set this parameter to PassEntry and the slider will only become active when the slider is moved past the Multi Entry Value. This results in smooth changes to the sound.

# MAIN2 Page

The MAIN2 page in Global Mode allows you to set up the feel and response of the Forte keyboard to your playing style, the intonation key of music, as well as how pianos and drums respond.



Parameter	Range of Values	Default Value
Velocity Map	Linear, Light1, Light2, Light3, Hard1, Hard2, Hard3, PianoTouch, Easy Touch, GM Receive	Linear
Pressure Map	Easiest, Easier, Easy, Linear, Hard, Harder, Hardest	Linear
Intonation Map	0 None, 1 Equal, 2 Just, 3 Just/b7th, 4 Harmonic, 5 JustHarm, 6 Werkmeister, 7 1/5thComma, 8 1/4thComma, 9 IndianRaga, 10 Arabic, 11 BaliJava1, 12 BaliJava2, 13 BaliJava3, 14 Tibetan, 15 Carlos A, 16 Pyth/aug4, 17 Pyth/dim5, 18 EastMed	1 Equal
Int. Key	C, C#, D, D#, E, F, F#, G, G#, A, A#, B	C
DrumRemap	None, GM	None
Pedal Noise	Off, On	On
User Type	Regular, Advanced	Regular

## Velocity Map

The Velocity Map parameter determines the way the Forte generates MIDI velocity information. Different maps generate different MIDI velocity values for the same physical key strike velocity .

The default map (Linear) provides the widest range of velocity expression, but you may want to choose a different map if the default does not suit your playing style. You can select from any of the following settings:

<b>Light3 Light2 Light1</b>	Makes it increasingly easier to produce high MIDI velocity values for the same key strike velocity (with Light3 being the easiest). These maps work best for those with a light touch.
<b>Linear</b>	The Forte default map. Linear, allows MIDI velocities to pass unchanged. It follows a linear response.
<b>Hard1 Hard2 Hard3</b>	Makes it increasingly harder to produce high MIDI velocity values for the same key strike velocity (with Hard3 being the hardest). These maps work best for those with a heavy touch.
<b>PianoTouch</b>	Simulates the general velocity response of an acoustic piano, and is best suited for playing acoustic piano programs.
<b>Easy Touch</b>	Similar to the Light1/Light2/Light3 settings. Makes higher velocities easier to play, but allows more sensitive control over playing high velocities by not boosting the MIDI velocity for fast strike velocities as much as it does for medium strike velocities.
<b>GM Receive</b>	Mimics the velocity response commonly used by keyboards that use the General MIDI (GM) sound set. The GM Receive map makes medium strike velocities produce higher MIDI velocities compared to the Linear map.

## Pressure Map

The Pressure Map parameter determines the way the Forte controls Pressure (Aftertouch). Different maps generate different MIDI pressure values for the same physical key depending on how hard you press and hold the key.

<b>Easiest Easier Easy</b>	Makes it increasingly easier to produce high MIDI pressure values. (with Easiest being the easiest).
<b>Linear</b>	The Forte default map. Linear, allows MIDI pressure (aftertouch) to pass unchanged. It follows a linear response.
<b>Hard Harder Hardest</b>	Makes it increasingly harder to produce high MIDI pressure values (with Hardest requiring most pressure).

## Intonation Map

Most modern western music uses what is known as equal temperament. This means that the interval between each semitone of the 12 tone octave is precisely the same as every other semitone.

However, many different intonation intervals have evolved over the centuries and across cultures and instruments, so equal temperament will not sound appropriate for certain styles of music. The Forte supplies you with 18 different factory intonation maps which are useful for a range of different styles.

Like many instruments before the adaptation of equal temperament, most of these intonation maps were designed to sound best in one specific key. Though some may have historically been in a different key, all of the Fortes factory intonation maps are set to root note C by default. You can change the root key of the current intonation map by using the Int.Key parameter (see the Intonation Key (Int.Key) section below.)

<b>0 None</b>	No intonation map is used, intonation is equal.
<b>1 Equal</b>	No detuning of any intervals. The standard for modern western music.
<b>2 Just</b>	Tunings are defined based on the ratios of the frequencies between intervals. The original tuning of Classical European music.
<b>3 Just/b7th</b>	Similar to Just, but with the Dominant 7th flatted an additional 15 cents.
<b>4 Harmonic</b>	The perfect 4th, Tritone, and Dominant 7th are heavily flatted.
<b>5 JustHarm</b>	Approximation of a historical intonation.
<b>6 Werkmeister</b>	Named for its inventor, Andreas Werkmeister. It's fairly close to equal temperament, and was developed to enable transposition with less dissonance.
<b>7 1/5thComma</b>	Approximation of a historical intonation based on the comma system.
<b>8 1/4thComma</b>	Approximation of a historical intonation based on the comma system.
<b>9 IndianRaga</b>	Based on the tunings for traditional Indian music.
<b>10 Arabic</b>	Oriented toward the tunings of Mid-Eastern music.
<b>11 BaliJava1</b>	Based on the pentatonic scale of Balinese and Javanese music.
<b>12 BaliJava2</b>	A variation on BaliJava1, slightly more subtle overall.
<b>13 BaliJava3</b>	A more extreme variation.
<b>14 Tibetan</b>	Based on the Chinese pentatonic scale.
<b>15 Carlos A</b>	Developed by Wendy Carlos, an innovator in microtonal tunings, this intonation map flats each interval increasingly, resulting in an octave with quarter-tone intervals.
<b>16 Pyth/aug4</b>	This is a Pythagorean tuning, based on the Greek pentatonic scale. The tritone is 12 cents sharp.
<b>17 Pyth/dim5</b>	This is a Pythagorean tuning, based on the Greek pentatonic scale. The tritone is 12 cents flat.

## Int. Key (Intonation Key)

This sets the tonic, or base note from which the currently selected intonation map calculates its intervals. If you select G as the intonation key, for example, and the intonation map you select tunes the minor 2nd down by 50 cents, then G# will be a quartertone flat relative to equal intonation. If you change the intonation key to D, then D# will be a quartertone flat. If you use nonstandard intonations, you'll want to set Int.Key to the key you're playing in.

If the Intonation parameter is set to Equal, changing Int.Key has no effect.

## Drum Remap

This parameter will remap all Drum programs to conform to the General MIDI (GM) drum map, a standard drum map used in many keyboards and synthesizers. The GM drum map isn't optimally intuitive in terms of playability, so by default the Forte uses a unique keymap that is more intuitive and lends better to performance. However, the GM drum map is so commonplace that many players feel more comfortable playing drum programs with the GM drum map. Because of this, the Forte is designed such that you can remap drum programs to the GM drum map.

When the Drum Remap is set to None, no remapping takes place in Program mode.

When the Drum Remap is set to GM, the Forte remaps Drum programs to the GM drum map.

## Pedal Noise

Some piano Programs have a Pedal Noise feature programmed into the sound. This parameter allows you to turn the Pedal Noise off if you prefer not to use it. If it is on, it will only activate noise on those Programs that have been programmed to use it.

## User Type

Setting the User Type parameter to Advanced allows you to access a larger range of Insert and Aux Effects Chains, as well as 16 banks of Favorite Programs and Multis when Favorites View is selected (see the Global Mode "Display" parameter for details on Favorites view). By default the User Type parameter is set to Regular, which gives a more limited range of Effects Chains, and only one bank of Favorite Programs and Multis.

With User Type set to Regular, Insert and Aux Chain selection in Program Edit Mode will only scroll through IDs in the 4000's and 5000's respectively. To choose an ID out of these ranges, you can enter an ID number with the keypad, followed by the pressing Enter button. With User Type set to Advanced, Chain IDs in any range can be scrolled to.

Chain IDs 4000-6000 are used by the Forte factory programs, and when selected in Program Edit Mode, each Chain will automatically apply controller assignments for effects parameters on the Parameters page. Controller assignments for each of these Chains conform to the Controller assignments shown in the Forte Controller Conventions chart on page 6-12.

If the User Type parameter has been set to Advanced and Favorites view is selected, you can use the Channel/Zone buttons in Program and Multi Mode to scroll through 16 banks of 10 Favorite Programs and/or Multis, allowing you to save and access 160 Favorites. With these settings, Program and Multi mode will show the current Favorites Bank number in the upper right hand corner of the screen instead of the current MIDI channel.

## Switch Pedal Overrides

The Switch Pedal Override parameters (SW1-3 Override) allow the controller assignments for the Switch Pedals to be changed for all Programs and Multis. (KB3 organ programs have a separate override for the SW1 pedal, see the Rotary Override section below for details.)

The alternative assignments available for the Switch Pedal Overrides include the standard pedal controls of Sustain, Sostenuto and Soft as well as DataInc, DataDec, FavoriteInc and FavoriteDec, which can be used to change Programs, Multis or Favorites by using a pedal.

Use the DataInc and DataDec assignments (data increment/decrement) to select the next or previous ID when you depress the pedal. If you are in Program mode, DataInc and DataDec will select the next or previous Program. If you are in Multi mode, DataInc and DataDec will select the next or previous Multi.

Use the FavoriteInc and FavoriteDec assignments (Favorite increment/decrement) to select the next or previous Favorite when you depress the pedal. If you are not playing any Favorites, FavoriteInc and FavoriteDec will select the first Favorite, or the last Favorite that was selected since turning on the Forte.

In Multi Edit Mode, if a pedal is selected which has a pedal override enabled in Global mode, a message “Global Pedal Override is enabled” will display when that pedal is viewed to remind you that the Global mode pedal override settings are being used instead of the Multi mode pedal settings.

In Multi Edit Mode, setting a Pedal Mode to “Off” will disable the override for that Pedal in the selected Zone. It can be useful in Multi Mode to disable the Pedal Override for some Zones. For example, you may want to use a Pedal Override to control Sustain in all Zones of a Multi, but disable Sustain for one Zone.

When a Pedal Switch Override is used, the pedal will behave in Multi Mode as if the OnValue and OffValue are set to 127 and 0 respectively (this will not be shown in Multi Edit Mode). When a Pedal Switch Override is set to Sustain, Sostenuto or Soft, the pedal will behave in Multi Mode as if Pedal Type is set to Momentary (this will not be shown in Multi Edit Mode). When set to DataInc, DataDec, FavoriteInc or FavoriteDec the pedal will behave in Multi Mode as if Pedal Type is set to Toggle (this will not be shown in Multi Edit Mode).

## CC Pedal Overrides

In a similar manner to Switch Pedal Overrides, the CC Pedal Override parameters (CC1-2 Override) allow the Continuous Control Pedal assignments to be changed for all Programs and Multis. The alternative assignments available for the CC Pedal Overrides include Mod Wheel (MIDI CC 1), Foot/Wah (MIDI CC 4), Volume (MIDI CC7), Expression (MIDI CC11) and Pressure.

In Multi Edit Mode, if a pedal is selected which has a pedal override enabled in Global mode, a message “Global Pedal Override is enabled” will display when that pedal is viewed to remind you that the Global mode pedal override settings are being used instead of the Multi mode pedal settings.

## Rotary Override

By default KB3 organ programs have the Slow/Fast speed control for the Rotary speaker effect assigned to the Variation Button and the Sustain Pedal (SW1). The Rotary Override parameter allows you set the sustain pedal to function as sustain for all KB3 Programs, instead of Rotary Slow/Fast. The Variation button will always control the Rotary speed, regardless of this parameter’s setting.

## MIDI Page

The Forte can transmit and receive MIDI via its MIDI ports and USB. The MIDI page in Global Mode allows you to configure how this will be handled.

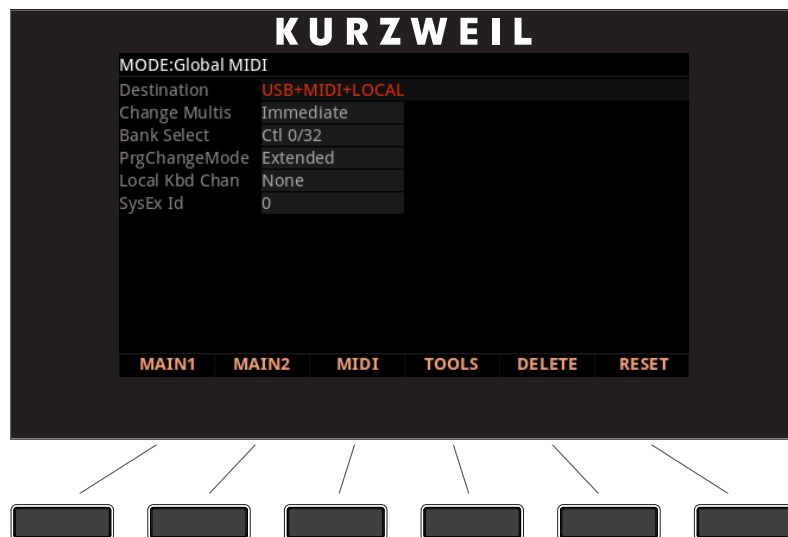

Parameter	Range of Values	Default Value
Destination	NONE, LOCAL, MIDI, MIDI+LOCAL, USB, USB+LOCAL, USB+MIDI, USB+MIDI+LOCAL	USB+MIDI+LOCAL
ChangeMultis	Immediate, AllKeysUp	Immediate
Bank Select	Ctl 0, Ctl 32, Ctl 0/32	Ctl 0/32
PrgChangeMode	Extended, K2600	Extended
LocalKbdChan	None, 1 to 16	None
SysExID	0 to 127	0

## Destination

The Destination parameter determines the destination of MIDI data generated by striking keys or activating controllers. This data can be sent to the Forte sound engine, through the MIDI out ports, or both. You can set this parameter to any of the three destinations for this parameter:

Note that this parameter is always active and works in conjunction with the Multi Mode Destination parameter (see page 9-9). These parameters act like filters, so if the Multi Mode Destination parameter is set to USB+MIDI+LOCAL and the Global Mode parameter is set to LOCAL, the MIDI data will only be transmitted locally.

<b>NONE</b>	No MIDI data transmission from the Forte. The Forte can still receive incoming MIDI data.
<b>LOCAL</b>	MIDI data is sent only to the Forte sound engine. MIDI Out is disabled.
<b>MIDI</b>	MIDI data is sent only through MIDI Out. The sounds of the Forte are disabled
<b>MIDI+LOCAL</b>	MIDI data is sent both to the Forte sound engine and through the MIDI Out.
<b>USB</b>	MIDI data is sent only through the USB port. The sounds of the Forte are disabled
<b>USB+LOCAL</b>	MIDI data is sent both to the Forte sound engine and through the USB port.
<b>USB+MIDI</b>	MIDI data is sent both to the MIDI OUT and USB port.
<b>USB+MIDI+LOCAL</b>	MIDI data is sent to the MIDI OUT, USB port. and to the Forte sound engine.

If you want to play the Forte, but not send any MIDI information to other MIDI instruments, then select LOCAL.

## Global Mode

### MIDI Page

---

If you want to use the Forte strictly as a MIDI controller for the other modules in your MIDI chain using the MIDI port, then select MIDI.

If you want to make use of the Forte's sounds as well as use it as a MIDI controller (MIDI port), then select MIDI+LOCAL.

If you want to use the Forte strictly as a MIDI controller for the other modules in your MIDI chain using the USB (Computer) port, then select USB.

If you want to use the Forte strictly as a MIDI controller for the other modules in your MIDI chain using the MIDI port and the USB (Computer) port, then select USB+MIDI.

If you want make use of the Forte's sounds and use it as a MIDI controller for the other modules in your MIDI chain using the MIDI port and the USB (Computer) port, then select USB+MIDI+LOCAL.



**CAUTION:** It is possible to stop all MIDI transmission, in Multi Mode, if the Destination parameter is set to LOCAL, and the other is set to MIDI or USB.

## Change Multis

The Change Multis parameter determines the exact timing of Multi changes when you select a different Multi, either by a normal data entry method or via MIDI program change commands.

Choose AllKeysUp to indicate that you want Multi changes to take place only when you've released all currently held notes.

Choose Immediate to indicate that you want such changes to happen immediately when you select the Multi.

## Bank Select

The Bank Mode parameter determines the controller number with which MIDI Bank change messages are received.

For MIDI Bank change messages, various manufacturers have chosen different MIDI controller numbers. Most have chosen Ctl 0, Ctl 32, or both. You can set this parameter to any of the following three controller IDs:

<b>Ctl 0</b>	MIDI Bank change messages are sent with controller number 0.
<b>Ctl 32</b>	MIDI Bank change messages are sent with controller number 32.
<b>Ctl 0 / 32</b>	MIDI Bank change messages are sent with both controller numbers 0 and 32.

## PrgChangeMode

The Program Change Mode (PrgChangeMode) parameter determines the format of program change messages received by the Forte.

Program Change Type	For Use With
Extended	Bank changes and Program changes. A bank has 128 IDs. Note that our system will recognize 16 banks, from 0 to 15. (2048 IDs).  This is for connecting a PC2 or a generic MIDI device as a controller device.
K2600	Bank changes and Program changes. A bank has 100 IDs. Our system will recognize in this case 21 banks, from 0 to 20. For example, with MIDI out from a K2600 into the MIDI in of the Forte, if you scroll or enter a number in the K2600, you will see the same numbers in the K2600 and in the Forte if the programs exist.

## LocalKbdChan (Local Keyboard Channel)

Changing the setting of the Local Keyboard Channel parameter is useful only when the Forte is receiving MIDI information from an external source. Perhaps you have a favorite MIDI keyboard that you use to control all the gear in your studio, or you use a lot of outboard sequencing. If you're using the Forte as a standalone music workstation or performance keyboard, you can ignore this parameter and leave it set to None.

The local keyboard channel enables the Forte to receive MIDI information on a single channel, then rechannelize that information so you can play and control all four Zones of a Multi, even if your MIDI source transmits on only one channel.

### Program Mode

When you're in Program Mode, the local keyboard channel remaps incoming information to the Forte's current channel. When using the local keyboard channel, all the MIDI information received on the Local Keyboard Channel gets sent, after being remapped to the Forte's MIDI Out and USB ports.

You may find it more convenient to use the local keyboard channel. In this case, the Forte remaps incoming MIDI to the Forte's current channel, so in Program Mode, you'll always play the Program on the Forte's current channel. Incoming MIDI also gets sent to the Forte's MIDI Out and USB port. When this parameter is set, you will need to transmit on the local keyboard channel from your DAW or controller keyboard for the Forte to respond correctly.

#### Multi Mode

Things are a bit different for playing Multis. In this case, you must use the LocalKbdChan to be able to play and control all of the Multis Zones. Set LocalKbdChan to match the channel your external MIDI source is using (for example: your MIDI source transmits on Channel 1, set LocalKbdChan to 1). All MIDI information that the Forte receives on the local keyboard channel gets remapped to the channels and control destinations used by the Zones in the Multi.

The Forte also remaps certain MIDI Controller messages that it receives on the Local Keyboard Channel so that they correspond (in most cases) to the default assignments for the Forte's physical controllers (Mod Wheel, sliders, etc.). Physical controller assignments are handled by Multis and are defined per Zone in Multi Edit Mode. Each Zone of a Multi has its own controller assignments.

#### Sysex ID

The SysEx ID parameter determines the ID number for the unit if you are using more than one device with the same MIDI manufacturer ID number. You can set this parameter to any number from 0 to 127.

Unless you have multiple Forte keyboards receiving Sysex messages from a single source, you will not need to change the Sysex ID from the default setting of 0.

If you do have multiple Fortes receiving Sysex messages from a single source, make sure each Forte has a different Sysex ID. This will allow you to direct Sysex messages to the appropriate Forte by specifying which unit with the Sysex ID byte that's included with every Sysex message.

To have the unit respond to Sysex messages regardless of the Sysex ID, set Sysex ID to 127.

## TOOLS Page

Pressing the TOOLS soft button calls up a page that gives you access to four analytic and diagnostic tools. Additionally, pressing the two center soft buttons will call up the TOOLS page from any mode.

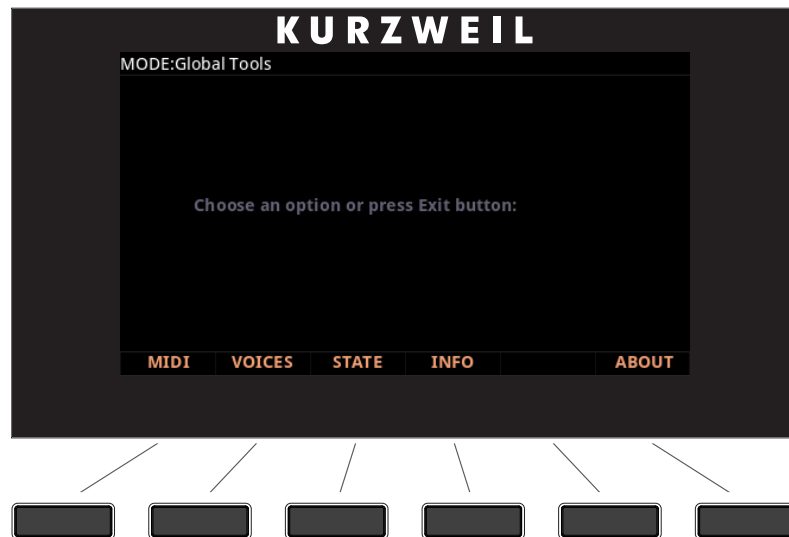

Press the “EXIT” button when finished.

## MIDI

Pressing the MIDI soft button launches MIDIScope™, a useful subprogram that lets you monitor the MIDI messages from Forte and those received via MIDI in realtime. This is a good way to make sure you’re receiving MIDI from MIDI masters. It’s also good for making sure your controls are assigned as you want them, checking your attack velocities, checking your controller values, etc.

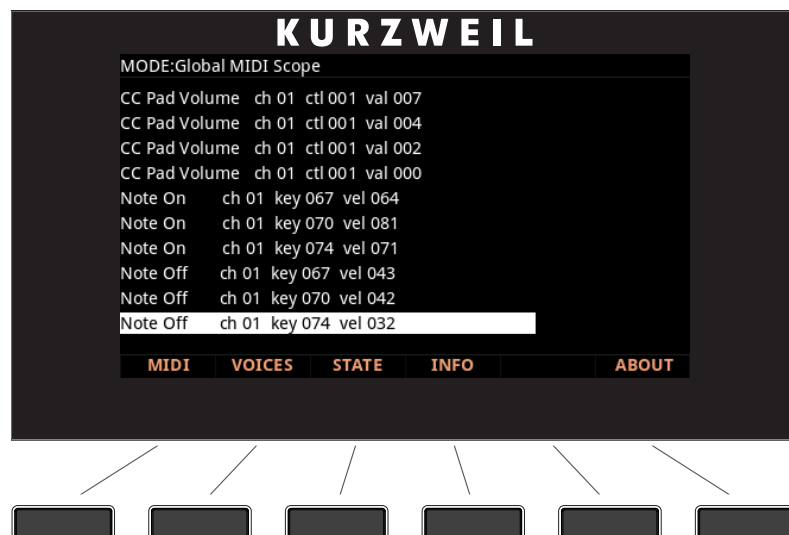

## VOICES

Pressing the Voices soft button calls up the Voice Status page, which shows the Forte's active voice channels as you play.

The Voice Status pages displays each active voice as an "M" for mono voices or displays stereo pairs of voices as an "S". Whatever symbol the page displays, when the key of a voice is released, that voice's symbol on the Voices Status page turns into a "D" during the release portion of that voice's envelope. When the voice decays to silence, it is no longer active, and the "D" disappears.

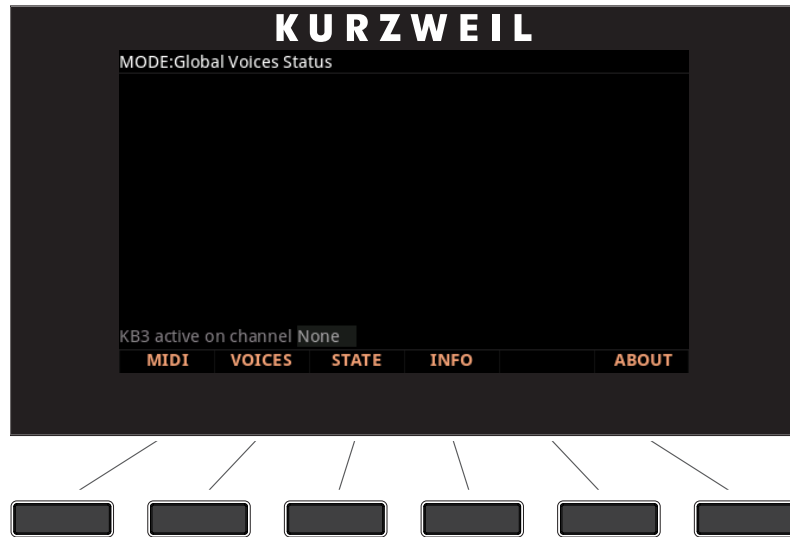

The Voice Status page gives you an indication of the envelope level of each voice, though not necessarily the volume level. Nonetheless, this can give you a valuable indication of how your voices are being used. For example, if all or most of the voices are active, then there's a good chance that when voice stealing takes place an audible voice will be reallocated.

KB3 Programs that simulate Hammond™ organs do not use any of the Forte's 128 voices of polyphony (this does not apply to KB3 Programs that emulate Vox™ or Farfisa™ organs). Only one KB3 Program can be active on the Forte's 16 MIDI channels at any time. The bottom of the voices page indicates which of the Forte's 16 MIDI channels (if any) has an active KB3 program.

## STATE

This utility shows the internal state of the MIDI CCs and pitch bend in any channel at a particular time.

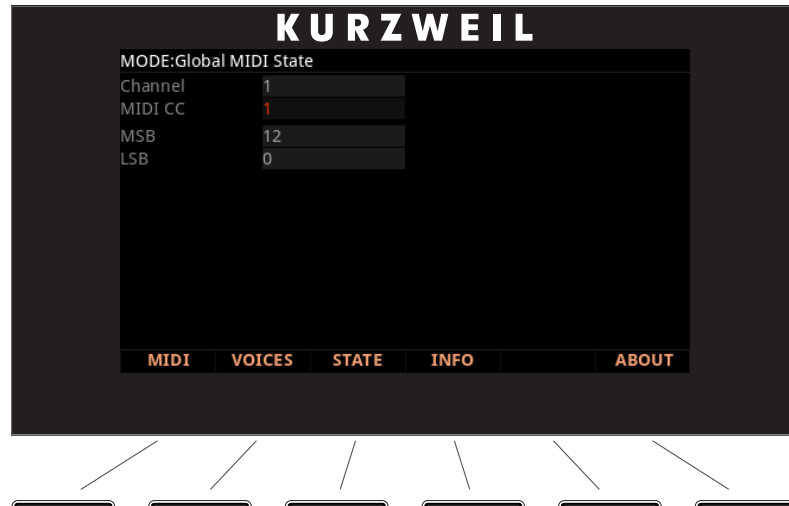

Typical use: “My channel X does not make any sound”. Is it MIDI 7 (Volume), is it MIDI 11 (Expression) or is it something else? With STATE you can check the status for various CCs per channel.

## INFO

The INFO page contains the system information indicating what version of operating system and objects is currently installed in your Forte keyboard.

Go to the Kurzweil website at <http://www.kurzweil.com> and make sure that you have the latest operating system available.

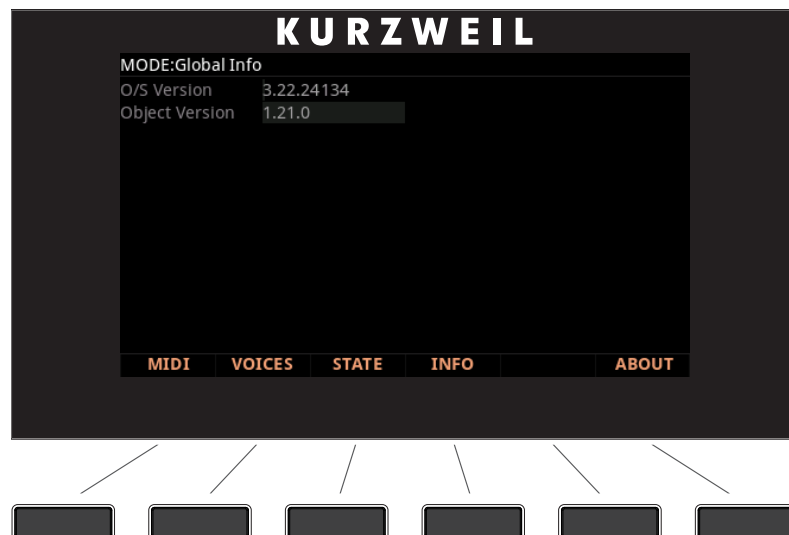

## ABOUT

The ABOUT Page displays the Forte splash screen and automatically scrolls a list of credits and acknowledgments.

## DELETE Page

The DELETE page is useful in deleting unwanted user-created objects in your Forte.

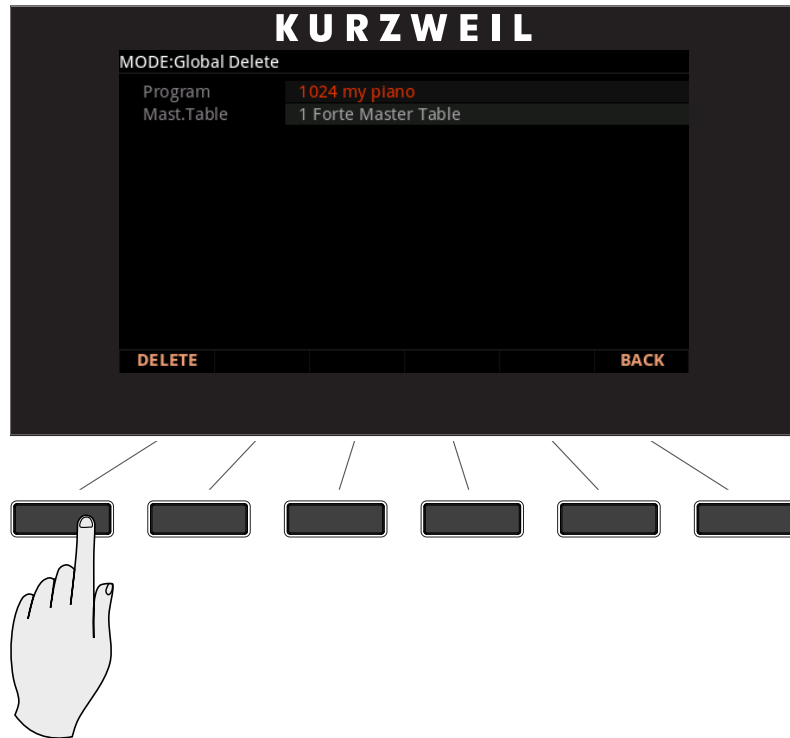

Select the Program or Multi that you wish to delete under the Program parameter and press the delete key. This action cannot be undone.



**CAUTION:** Be aware that deleting programs will permanently remove them from the Forte. If you wish to load the Program back into the Forte in the future, ensure that you save the Program to a flash drive or computer/tablet before deleting them.

## RESET Page

The RESET button allows you to reset the Forte back to the factory settings.



**CAUTION:** Be aware that performing a reset on the Forte will result in changes that can not be reversed. Kurzweil recommends that you save (STORE) all your Programs and Multis that you wish to keep before performing a reset on the Forte.

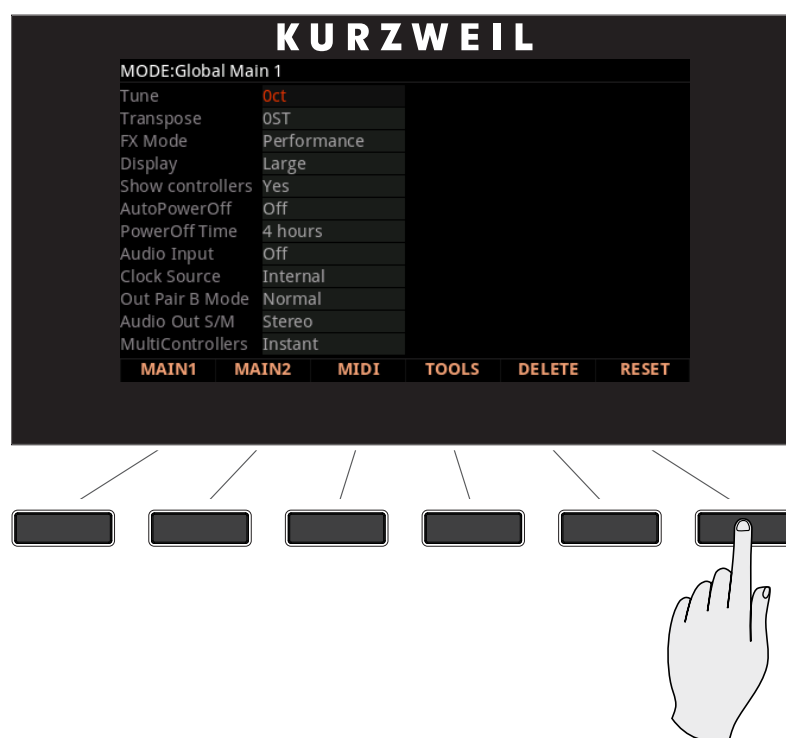

Press the RESET button to enter the reset process. You can CANCEL at any time if you are unsure, or do not want to proceed.

### Reset Forte To Its Factory State

The factory state means all your existing User Programs & User Multis will be permanently erased. This cannot be undone. Make sure you have used the Store function to backup all of the Programs and Multis that you wish to keep. All Global Mode parameters will be reset to default settings.

## Global Mode

### RESET Page



**CAUTION:** Performing the following reset, will result in **ALL** User Programs & User Multis being erased. Global parameters are returned to their default state. This cannot be reversed. Kurzweil recommends that you save (**STORE**) all your Programs and Multis that you wish to keep before performing a reset on Forte.

<b>User PROGRAMs</b>	<b>ALL USER PROGRAMS ARE DELETED.</b>
<b>User MULTIs</b>	<b>ALL USER MULTIS ARE DELETED.</b>
<b>Global Mode</b>	<b>ALL GLOBAL PARAMETERS ARE RESET TO THE ORIGINAL FACTORY DEFAULTS.</b>

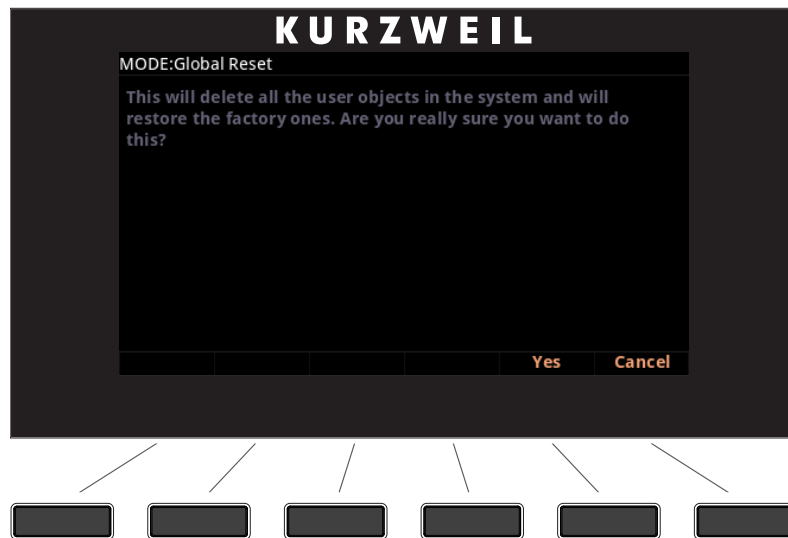

Once you press the Reset Soft Button you will be prompted to continue.

Press “Yes” if you wish to proceed with the System Reset.

Press “Cancel” if you are unsure, or do not wish to proceed with the reset.

A further prompt will be displayed.

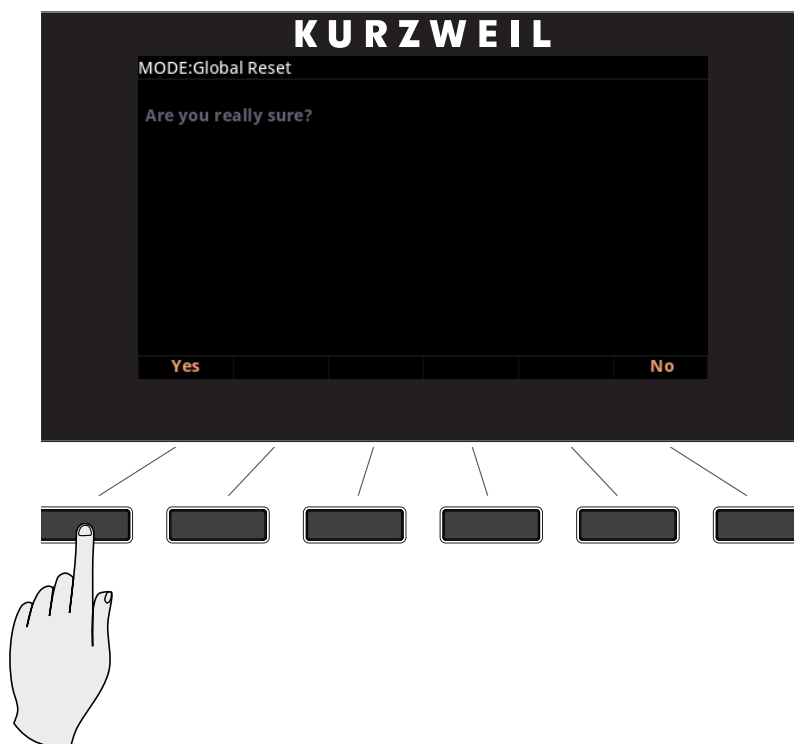

Press “Yes” if you wish to erase all the User Programs, User Multis and Global parameters and reset the Forte to the Factory State.

Press “No” if you are unsure, or do not wish to proceed with the reset.



# Chapter 11

## Storage Mode

Storage mode lets you use a USB device (such as a thumb drive) or a computer to load, store, back up, and copy files between the Forte and the outside world.

Storage mode in the Forte allows flexibility to organize files and their contents. Its features can save you time by allowing you to select and organize files and directories.

The rear panel connections used for storing and loading files are:

- USB (Type A) Storage port
- USB (Type B) Computer/Tablet port

### About Storage Mode

To enter Storage mode, press the Storage button. While you are in Storage mode, the Storage button's LED is illuminated.

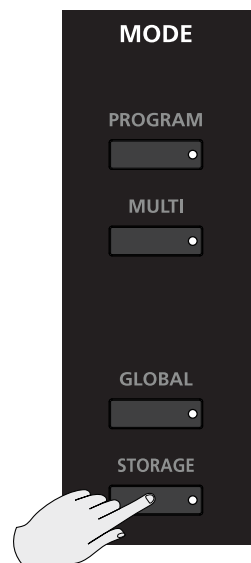

Whenever the Forte is accessing a storage device, the Storage Active LED will be lit.

## Storage Mode

### Storage Mode Common Features

Use this page to select the storage device you wish to use with the navigation arrows or the Alpha wheel. When a device is selected, you can then choose to Load or Store. If a storage device is not connected, Forte will prompt you with a message to do so.

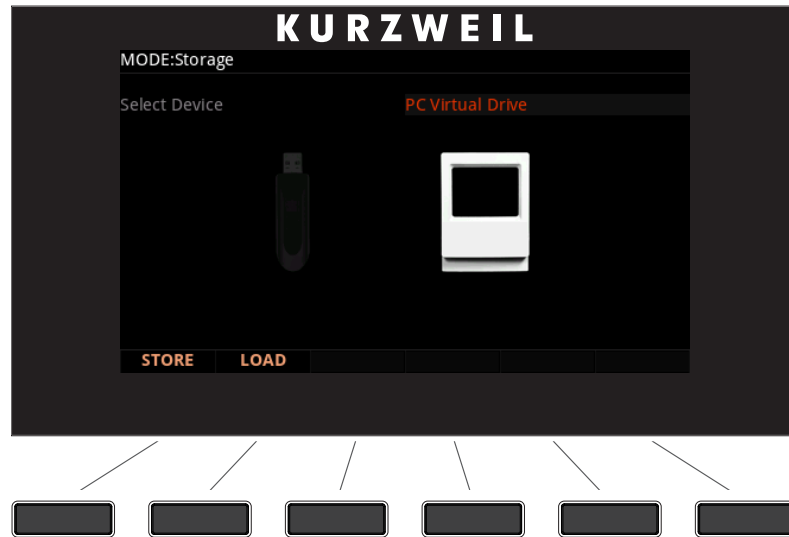

The top line of the display indicates you are in Storage Mode.

## Storage Mode Common Features

The following features are used in storage mode when saving or loading files.

### Directories

A directory lets you group files together as you might separate documents using folders in a file cabinet. By default all storage devices have at least one “root” directory. To organize files in a USB device; you can create additional directories, as well as subdirectories within directories. Directories appear in the file list with the indicator <DIR> to the right of the directory name.

### Path

When you choose the STORE or LOAD soft buttons on the Storage mode main page, you will have to choose exactly where in the storage device you wish to store to, or load from. This location is called a directory. When you need to choose a directory, you will see the Path field. The Path field shows the current directory on the current device.

When you choose a storage function for a connected device, Forte automatically chooses the root (top-level) directory for the Path field. The root directory is displayed as a backslash:

Path:\

When viewing a page that has the Path field, if there are any directories available in the root directory, you will be able to choose them from a list using the alpha wheel, cursor buttons, or - /+ (Previous/Next) buttons. Then, press the Open soft button to open that directory. The name of the directory will be displayed in the Path field. For example, if you have a directory called SOUNDS that is located in the current device's root directory, the Path field will appear as:

Path:\SOUNDS\

The backslash character is a directory separator, as in the following Path:

Path: \BACKUP\COVERBAND\SONGS\

This represents the directory SONGS, which is a subdirectory of the COVERBAND directory, which is a subdirectory of the BACKUP directory in the root directory. If the path is too long to fit on the display, it gets abbreviated. The maximum length of a path in the Forte is 64 characters (including the backslash characters).

Using the Open soft button causes you to navigate into directories and their subdirectories, away from the root directory. To navigate out of subdirectories back towards the root directory, use the Parent soft button to move one level back from the current directory

## Common Dialogues

These are dialogues that the Forte calls up when about to perform certain storage functions.

### The Select Directory Dialogue

When storing, the Forte will prompt you to select a directory in which to store.

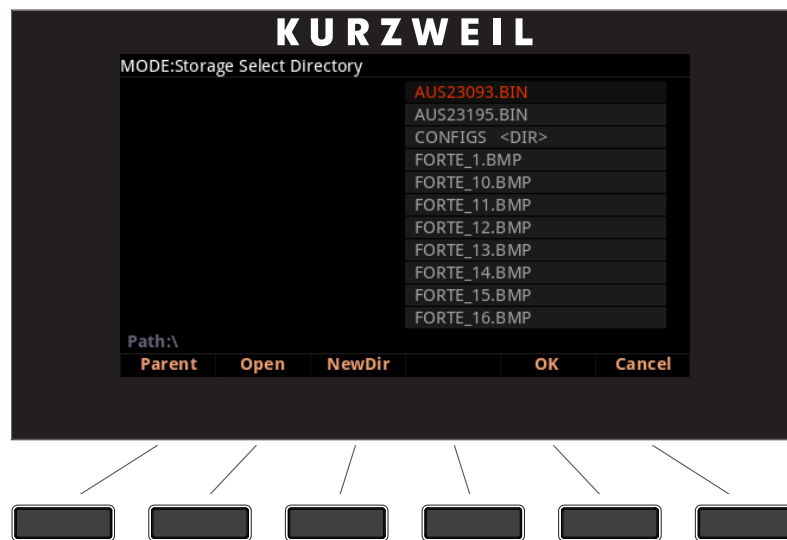

There are three navigating soft buttons on the left side of the bottom of the page:

## Storage Mode

### Storage Mode Common Features

<b>NewDir</b>	Create new directory. Calls up the New Directory dialogue (see the following section)
<b>Open</b>	Opens the highlighted directory
<b>Parent</b>	Moves you up one level in the directory hierarchy. If the display is already at the root directory, this button has no effect.

When you have chosen your directory, press the OK soft button to call up the File Name dialogue (see the following section) and complete the storing process.

### The File Name / New Directory Dialogue

When you create a new file in Storage mode, or create a new directory, the Forte prompts you to enter the name. This File Name dialogue appears as shown below:

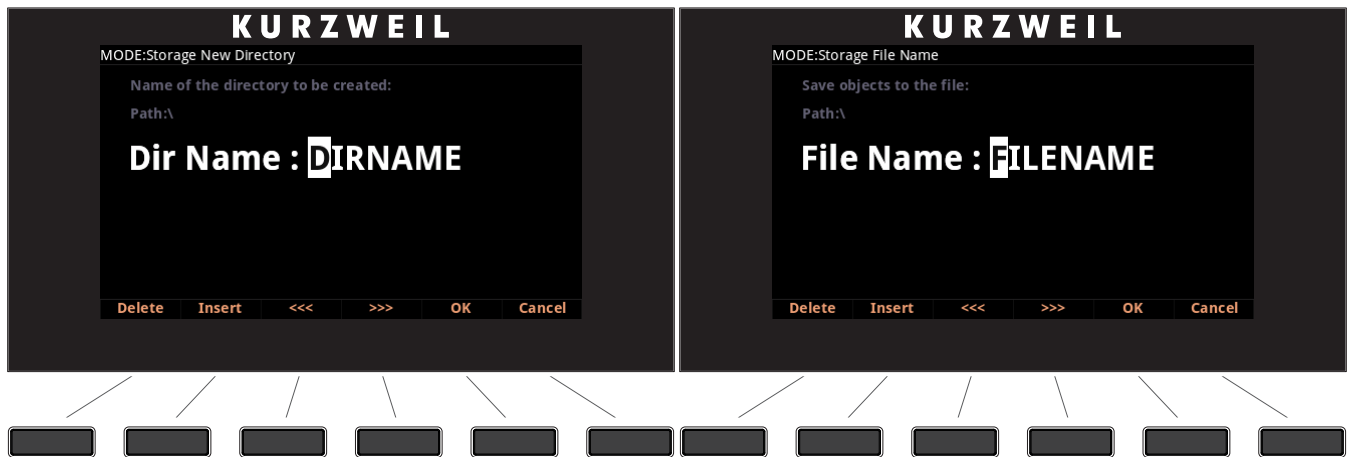

New file names will default to either FILENAME (after a powerup), or the name of the most recent file stored or loaded. New directory names will default to either DIRNAME (after a power up), or the name of the most recent file stored or loaded. You can edit the name using the keypad, alpha wheel, -/+ buttons, Left and Right cursor buttons, the Delete and Insert soft buttons, and the << and >> soft buttons.

Press the OK soft button to finish the operation.

## The STORE page

The STORE button allows you to store a file containing User Programs, User Multis and the User Master Table to a computer or storage device connected via a USB connection.

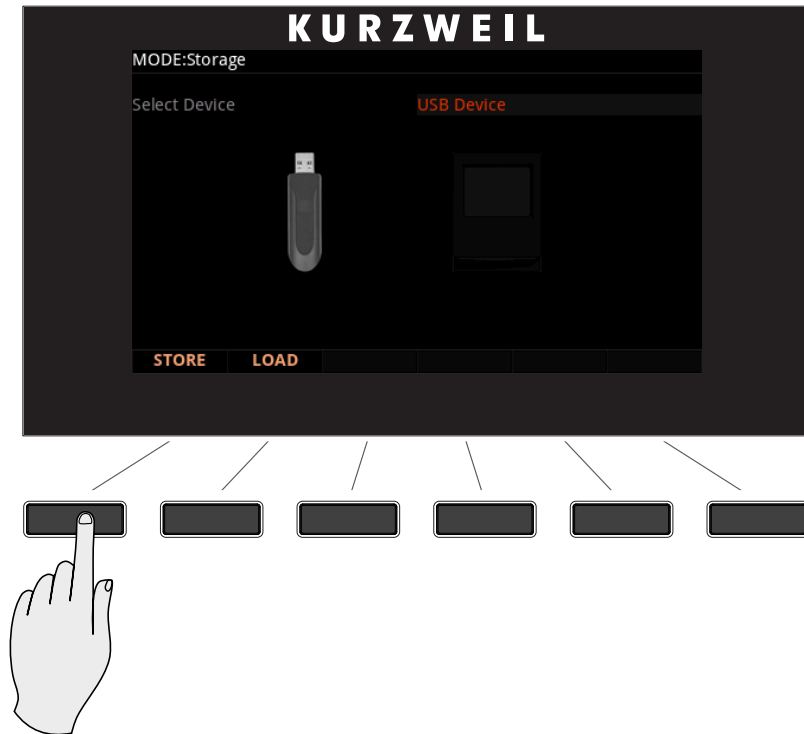

**NOTE :** If the Forte is currently connected to your computer as a MIDI controller, Saving or Loading a file in the PC Virtual Drive will temporarily disconnect the Forte USB MIDI connection for approximately 1 second. After Saving or Loading, the Forte may need to be reselected as a MIDI device in your computer program. Loading or Saving to the Flash Drive will not disconnect the USB MIDI connection.

Before you press the STORE selection button in Global Mode, make sure you have plugged the USB device into the Forte.

If you are storing sounds to your computer or Tablet, then use the cable that plugs into the computer/Tablet USB port on the rear panel of the Forte.

If you are storing sounds to a USB flash drive, plug them into the Device USB port on the rear panel of the Forte.

## Storage Mode

---

The STORE page

### Pressing STORE

Press the STORE button when you have a storage device plugged into a USB port.

If no USB connection is detected by the Forte, you will see the error message “Error: No valid device inserted.”.



Use the alphanumeric keypad function of the Category buttons to enter a file name (8 character limit) and press OK. Select Cancel if you do not wish store anything and exit.

The Forte stores files using the file extension of .FOR.

After storing, the Forte will prompt a message indicating if the store was successful or if a problem occurred.

## The LOAD page

The LOAD button calls up the LOAD page where you can load compatible files from a storage device.

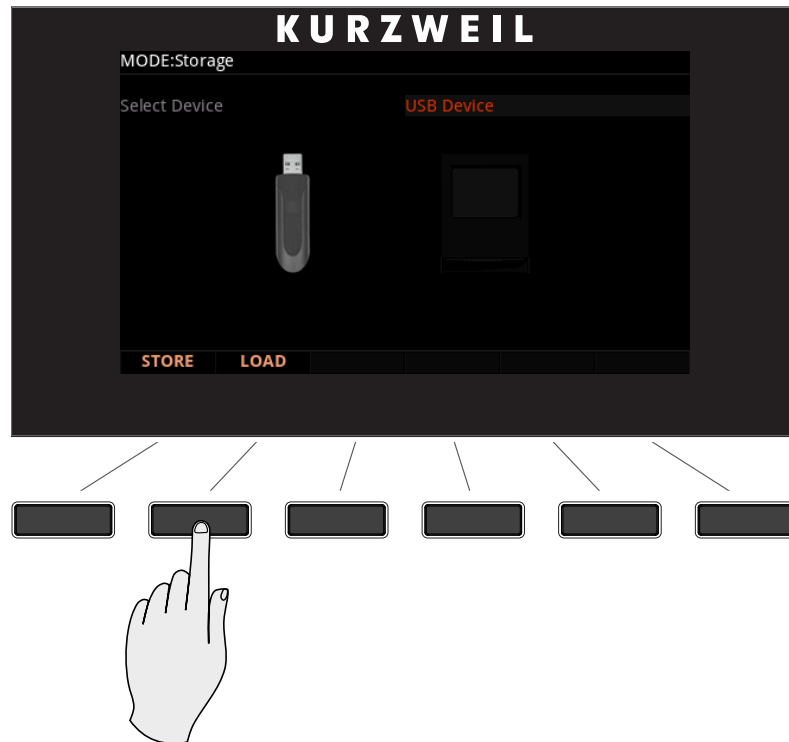

**NOTE :** If the Forte is currently connected to your computer as a MIDI controller, Saving or Loading a file in the PC Virtual Drive will temporarily disconnect the Forte USB MIDI connection for approximately 1 second. After Saving or Loading, the Forte may need to be reselected as a MIDI device in your computer program. Loading or Saving to the Flash Drive will not disconnect the USB MIDI connection.

Before you press the LOAD selection button in StorageMode, make sure you have plugged the USB device containing your User Programs and/or Multis into the back of the Forte.

If your User Programs/Multis are located on your computer or Tablet, then use the cable that plugs into the computer/Tablet USB port on the rear panel of the Forte.

If your User Programs/Multis are located on a USB flash drive, plug them into the Device USB port on the rear panel of the Forte.

## Storage Mode

The LOAD page

### Pressing LOAD

Press the LOAD button when you have the hardware containing your User Programs/Multis plugged into the USB port.

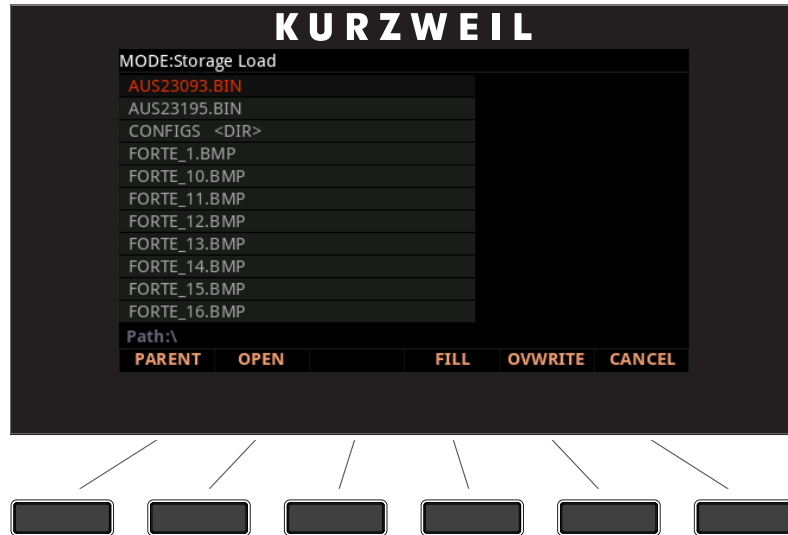

If no USB connection is detected by Forte, you will see the error message “Error: No valid device inserted.”.

Use the cursor buttons, -/+ buttons or the Alpha Wheel to browse the files in the currently selected storage device.

After selecting the file to load, press the OK Soft Button.

You will now be presented with options for how the User Programs/Multis will be loaded into the Forte. Selection is either FILL or OVWRTE.

<b>OPEN</b>	Selecting Open will open a selected folder.
<b>PARENT</b>	Selecting Parent will close an existing open folder.
<b>FILL</b>	Selecting FILL means you would like to keep the existing User Programs or Multis. Forte will now load the User Programs/Multis into the first empty ID slot it finds, and then subsequent empty slots.
<b>OVERWRITE (OVWRTE)</b>	Selecting OVWRTE first deletes all the existing User Programs or Multis, and then loads the new User Programs or Multis into the first user location at ID number 1024 onwards.

During the load process the screen will show information about the objects that are being loaded. At the end, the screen will display a message indicating if the load process was successful, or if there were errors.

## Example using LOAD

The following example shows how each different loading methods affect how four programs load into the User bank that already contains programs.

Example: Starting with the following objects already stored in the Forte User bank:

Programs currently in Forte	
Program ID	Program Name
1024	3rd World Order
1025	PC3 Strings
1028	JuPiTaR BazZ
1031	VA1 Lead

Suppose you were to load a FOR (Forte) file containing the following Programs:

File to be Loaded	
Program ID	Program Name
1025	Synth Horn
1026	NYJazzy
1027	Saxxy
1028	Stabbatha

The two tables below show the results if you use FILL or OVWRITE with the User Bank.

Forte Bank after using FILL	
Program ID	Program Name
1024	3rd World Order
1025	PC3 Strings
1026	Synth Horn
1027	NYJazzy
1028	JuPiTaR BazZ
1029	Saxxy
1030	Stabbatha
1031	VA1 Lead
1053	Rhoady EP

Forte Bank after using OVWRITE	
Program ID	Program Name
1025	Synth Horn
1026	NYJazzy
1027	Saxxy
1028	Stabbatha

## Storage Mode

---

The LOAD page

### Compatible Files

Forte can load .PC3, .P3K, .PLE, .ART, .SPX and .FOR files.

The Forte will read PC3-family files and will attempt a conversion of the objects on those files. While this process will not convert the objects 100%, it should get very close to the original sound.

# Chapter 12

## System Mode



**CAUTION: DO NOT ATTEMPT TO MAKE ANY CHANGES IN SYSTEM MODE UNTIL YOU HAVE READ AND FULLY UNDERSTOOD THIS CHAPTER**

This chapter will help you familiarize you with the functions of System Mode.

System Mode allows you to manage and upgrade the OS software of your Forte as well as perform diagnostic tests of the instrument's various internal systems and processes. Note that the functions that you have access to in System Mode govern the operation of your Forte, so only use System Mode when you must perform essential maintenance tasks.

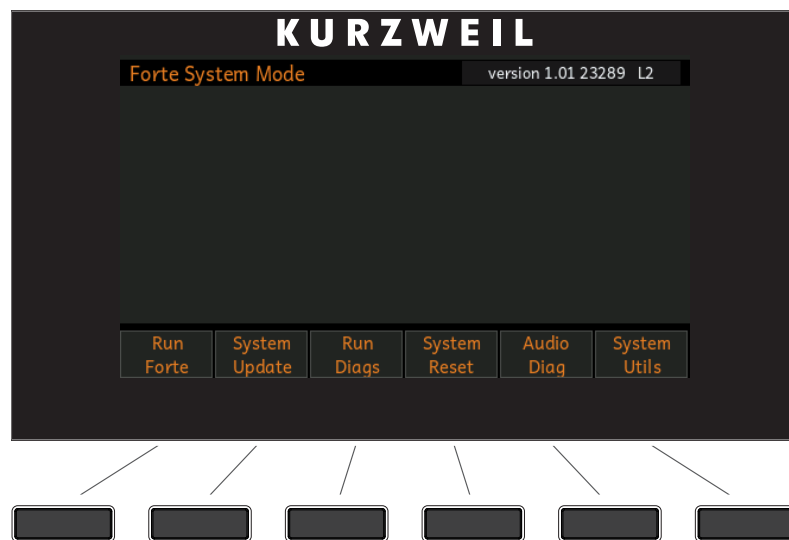

To enter System Mode, follow these steps:

1. Power off your Forte.
2. Press and the hold the **ENTER** button, and power on the unit. Make sure to keep holding the **ENTER** button until “Entering System Mode” is displayed:
3. Release the **ENTER** button—at this point, you are in System Mode.

## System Mode

---

### Run Forte

# Run Forte

This is the first System Mode menu item.

Pressing the “**Run Forte**” soft button will load the OS and the Forte will start up as if you just switched on the unit.

If the Forte operating system fails to load up, you will see an error message with an error code.

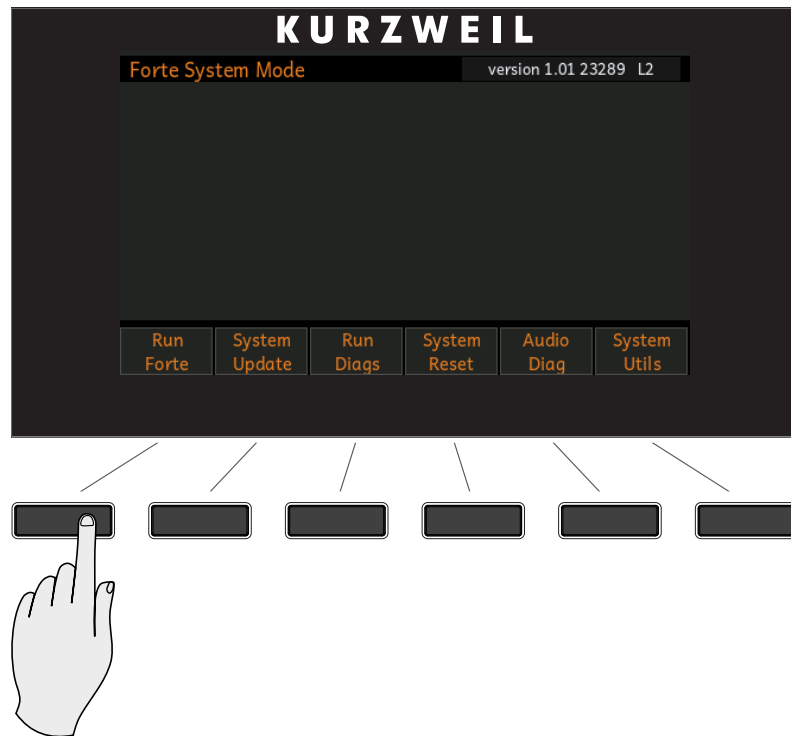

## System Update

System Update allows you to keep your Forte running the latest available OS (Operating System), which you can download from the Kurzweil website.

The file that is used to install a new OS version with sounds is combined into one file called a KUF (Kurzweil Unified File).

A USB flash drive or computer (using a USB cable) can be used to perform the System Update.

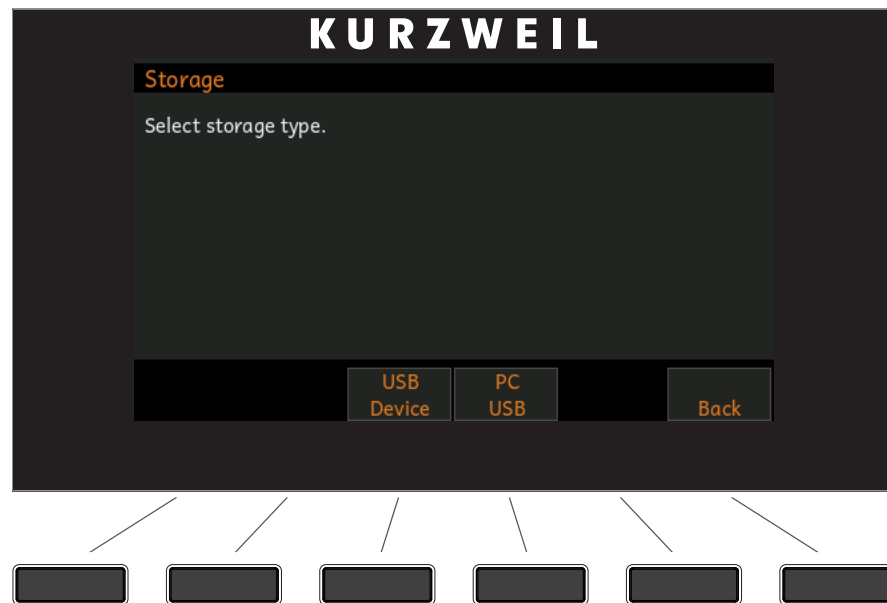

**Caution:** Before Updating, be sure to back up any custom programming.



**Caution:** It is important that the install is not disrupted once loading begins. Powering off the Forte or your PC, removing the USB device or USB cable in the middle of loading could leave the Forte inoperable and then require repair service to restore.

## Install using a USB flash drive

1. Download the System Update file from the Kurzweil website or another reliable source and save it in a known folder or directory on your flash drive.

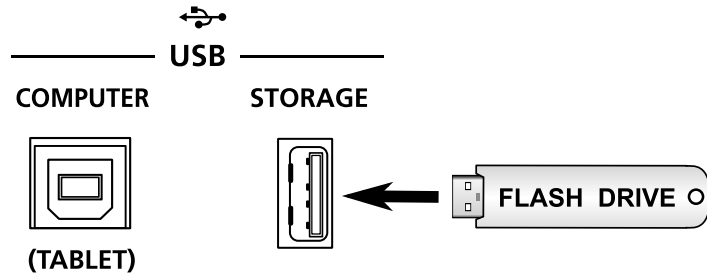

2. Connect the flash drive to the USB STORAGE slot of Forte (powered off).
3. Follow the instructions specified on Page 12-1 to enter System Mode.
4. In System Mode, select System Update.

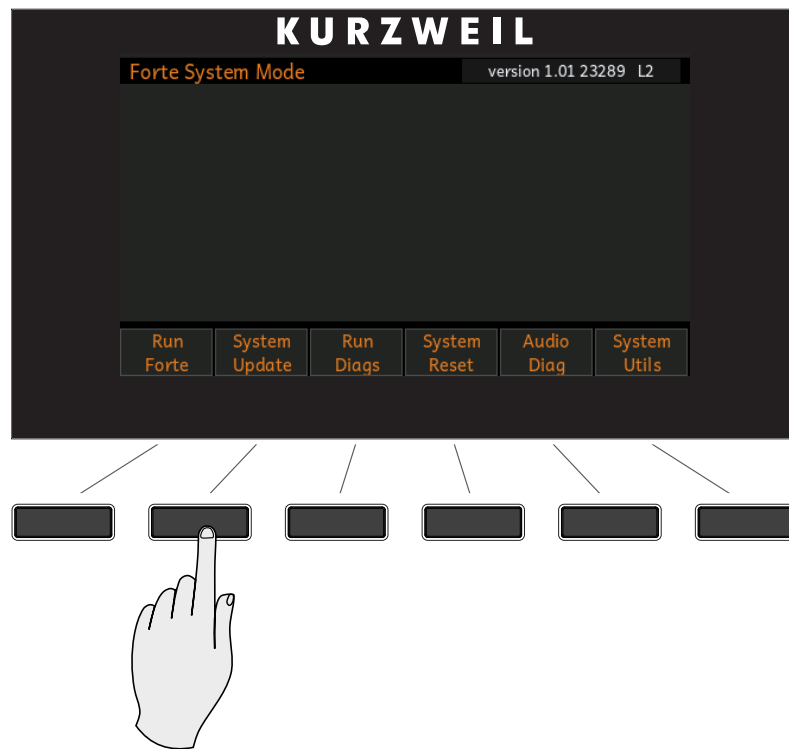

5. Select USB Device as the storage type.

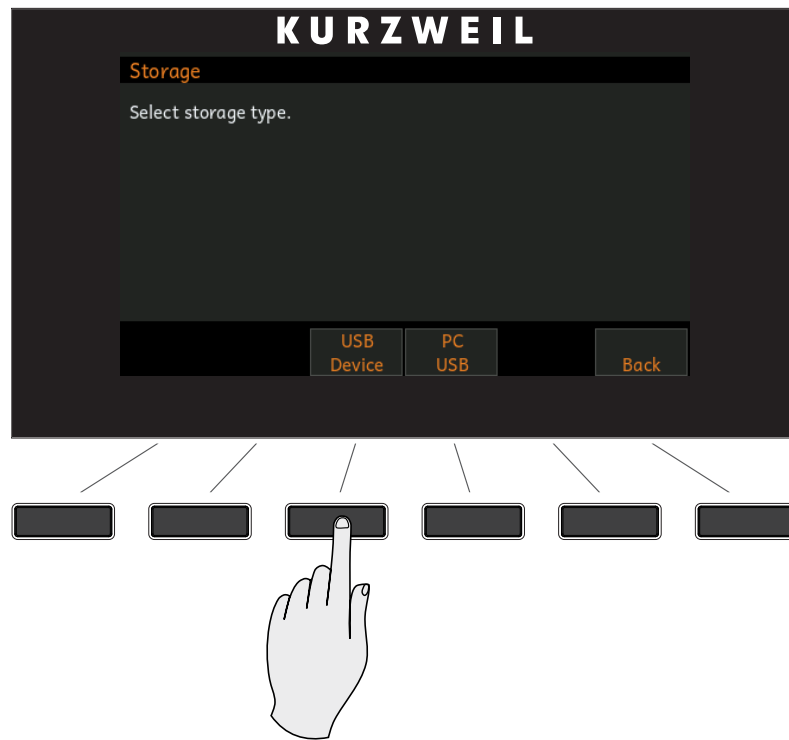

6. If the system was able to read the USB flash drive that was plugged in, it will display a list of files and folders as shown below. You can use the arrow buttons or Alpha wheel to move up and down the list. Select the UP soft button if you want to go up to the parent directory level. If the KUF file is selected, select the OK button.

## System Mode

### System Update

---

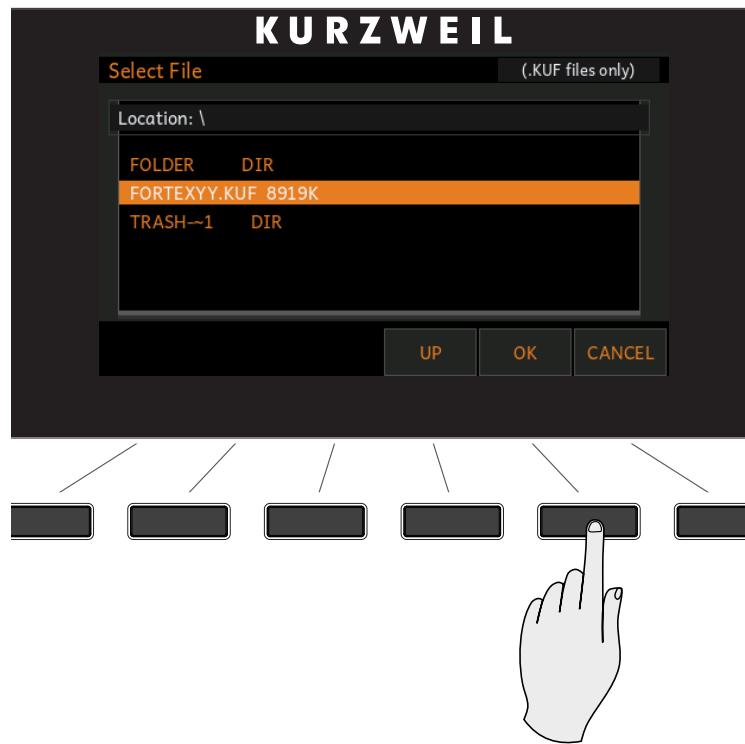

You will see a progress bar indicating the progress. If update was successful you will see a confirmation message. If there was a failure you will see a self-explanatory failure message (with error code) to indicate the failure.

## Install using a computer/tablet

1. Download the System Update file from the Kurzweil website or another reliable source and save it in a known folder or directory accessible to your computer/tablet.
2. Connect the Forte (powered off) to the computer/tablet with the USB cable provided into the USB Computer/Tablet slot.
3. Follow the instructions specified on Page 12-1 to enter System Mode.
4. In System Mode, select System Update.



5. Select PC USB as the storage type.

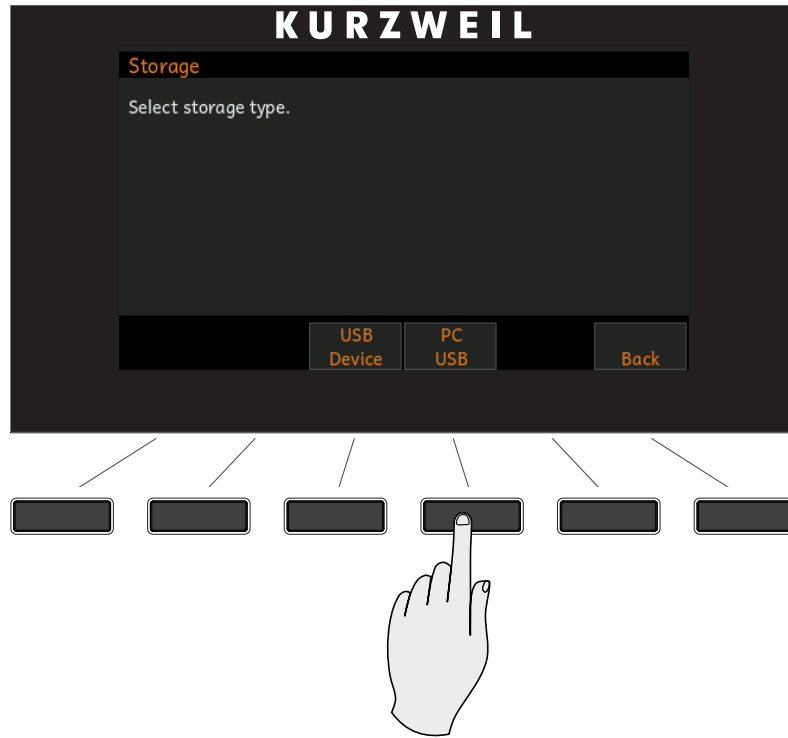

6. If the Forte cannot detect a connection to the computer/tablet it will display the message below.

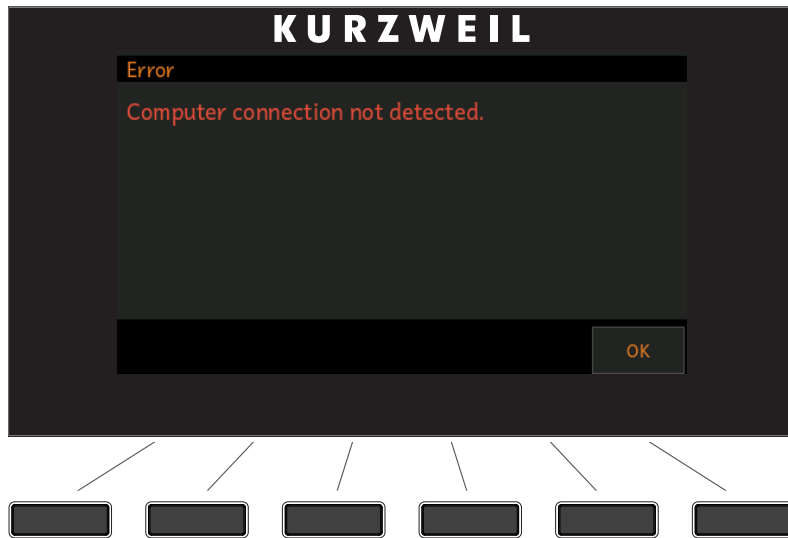

7. If the connection was detected, you will be prompted with the above message. Copy the KUF file to the virtual drive that appears on the computer/tablet and press OK.



8. Select the file from the list displayed on the next screen and Press OK.

You will see a progress bar indicating the progress. If update was successful you will see a confirmation message. If there was a failure you will see a self-explanatory failure message (with error code) to indicate the failure.

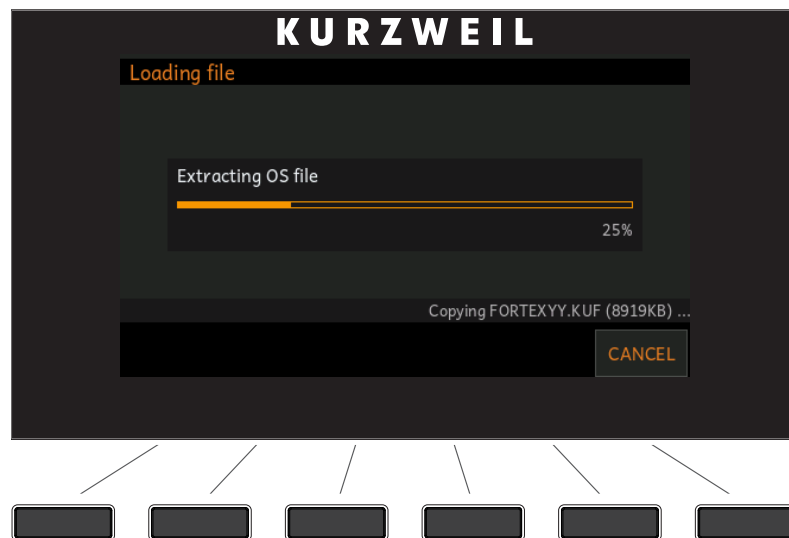

## System Mode

### Run Diagnostics

# Run Diagnostics

You will most likely not need to use the Run Diagnostics operations in normal cases.

These operations are mostly used at the factory and service centers by technicians for troubleshooting hardware problems. But, in some cases you might be required to run these diagnostics for troubleshooting and diagnosing symptoms. In these cases, follow the directions of Kurzweil Technical Support.

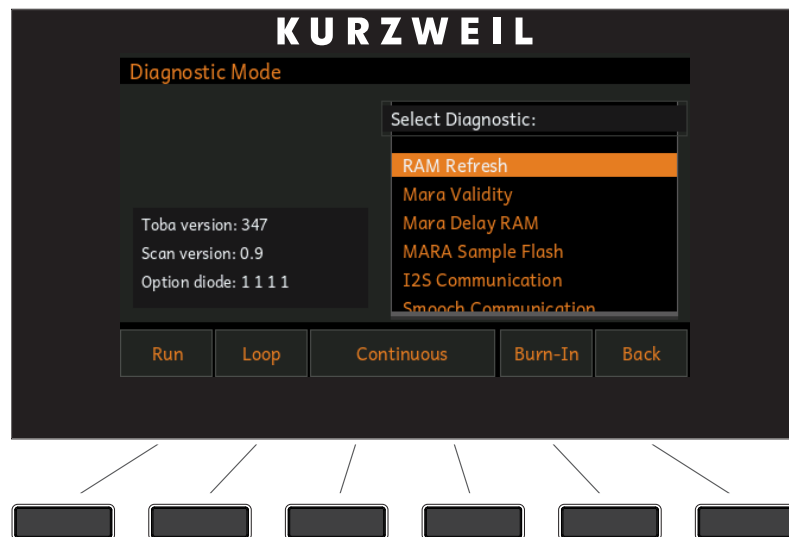
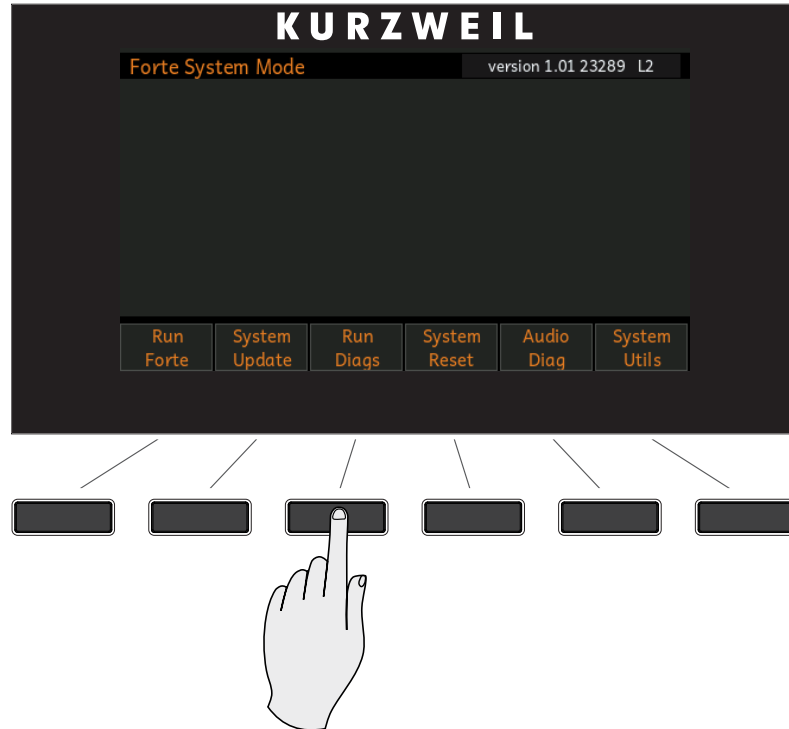

## System Reset



**CAUTION: THIS OPERATION ERASES ALL USER PROGRAMS & MULTIS.**

System Reset will restore the Forte back to a Factory State. In addition to all user Programs and Multis being deleted, Global Mode settings will be restored to factory defaults.

To clear all user Programs/Multis and restore the factory default state, select the System Reset menu option.

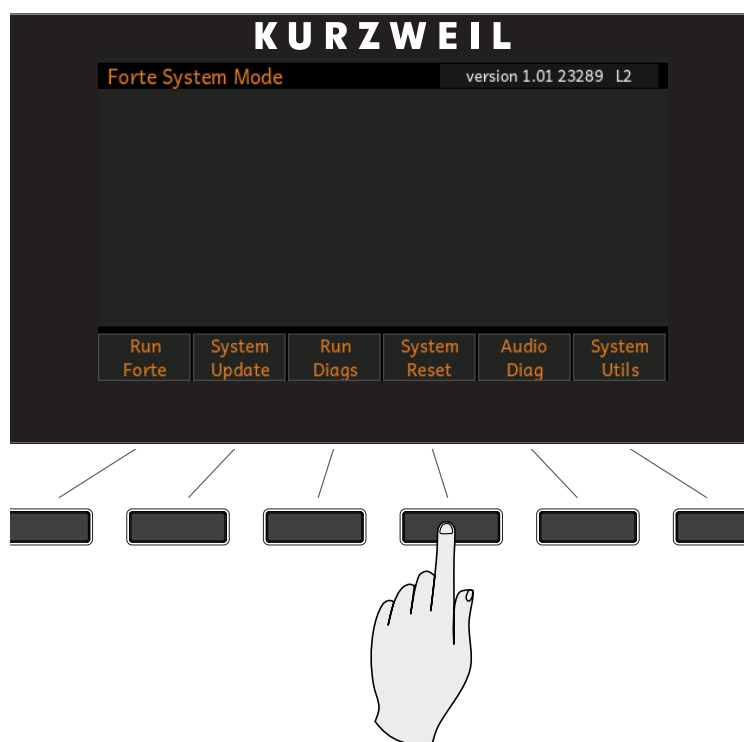

The Forte will now ask the question “This will delete all user objects. Are you sure?”

## System Mode

### System Reset

---

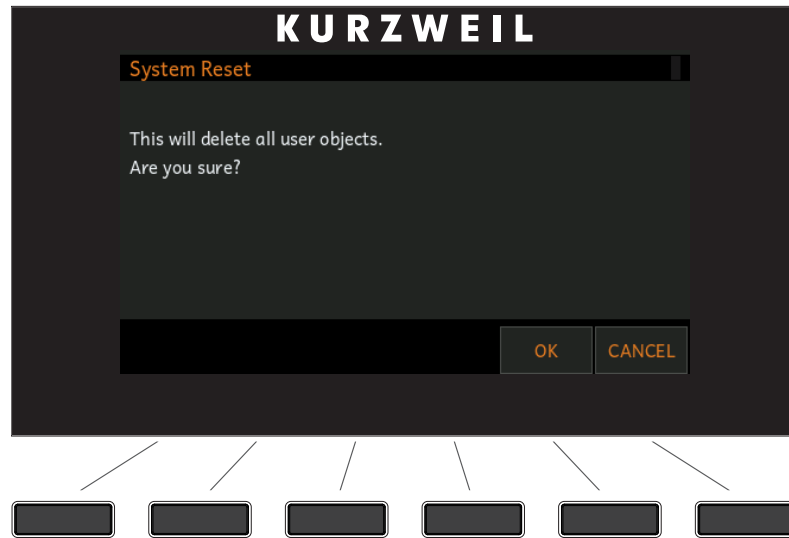

If you are not sure what you are about to do, select CANCEL. This will exit the System Reset process and take you back to the System Mode menu.

If you select OK the Forte will proceed with erasing all of the user objects (Programs & Multis) in the Forte and restoring the instrument back to a Factory State.

If you have completed the System Reset, select OK.

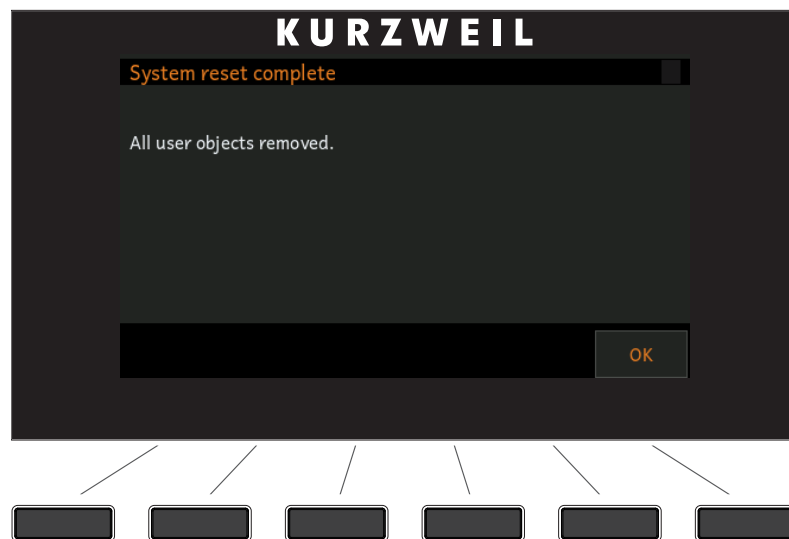

Remember to save your User Programs and User Multis to your computer following the instructions in the The STORE page on page 11-5. Once deleted, these files are completely removed from the Forte and there is no way to retrieve them.

# System Utilities

System Utilities contains various utilities for system administration.

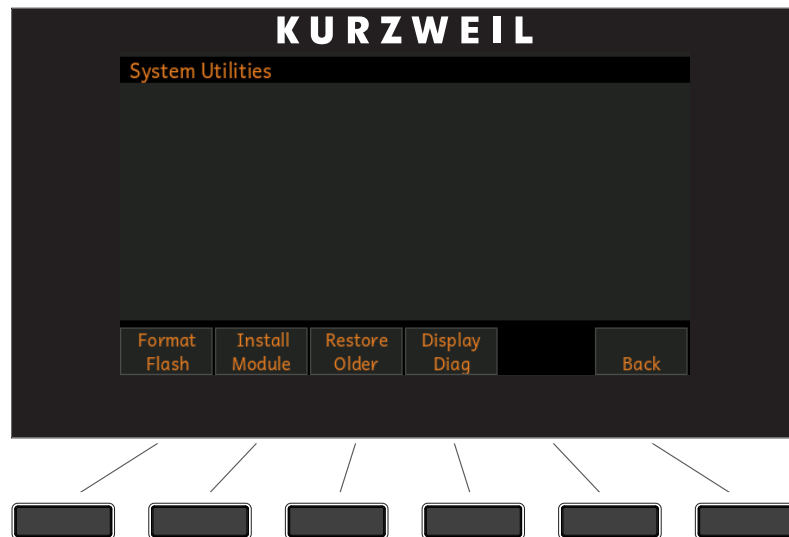
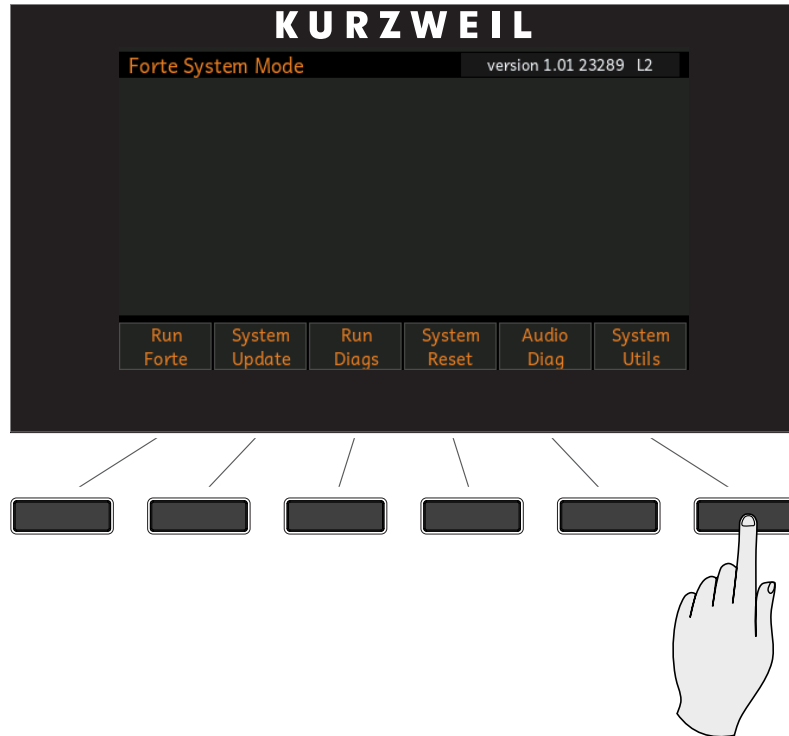

Select "Back" if you wish to exit and return back to the System Mode menu.

## Format Flash



**CAUTION: THIS OPERATION ERASES THE OPERATING SYSTEM, ALL FACTORY OBJECTS AND ALL USER OBJECTS.**

Performing this operation will format the Forte's system flash memory and erase the OS software as well as *all* Objects. Do not do this unless you think it is necessary in order to improve the performance of your Forte. Should you decide to do so, be sure to back up all of your files and software. After you do this, System Mode will still be available, so you can run updates and get your Forte up-and-running again. After a Format the unit will come up in System Mode by default.

To perform a Format, follow these steps:

1. Follow the instructions specified on Page 12-1 to enter System Mode.
2. Select System Utilities.

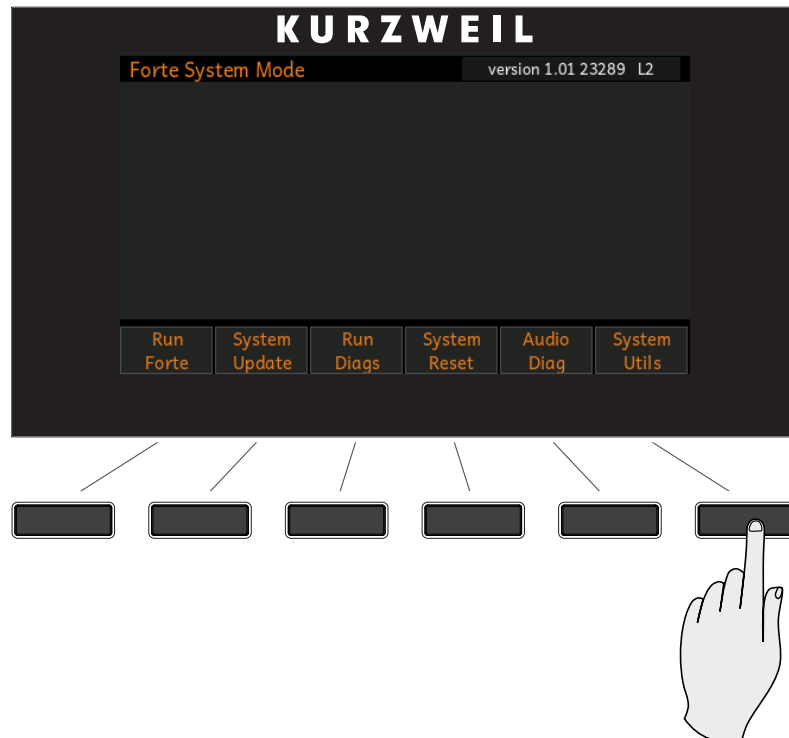

3. Press Format Flash.

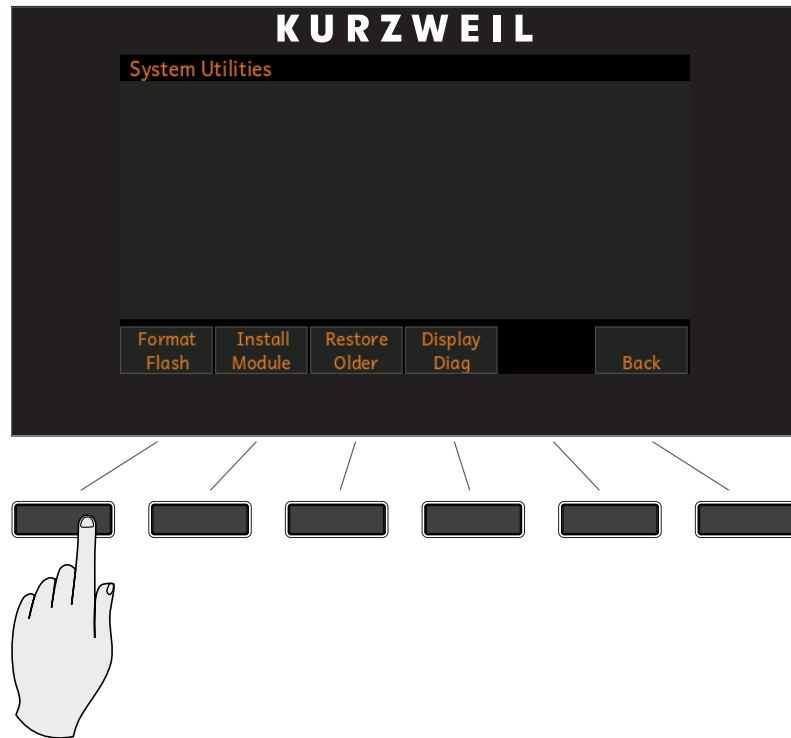

4. The next screen wants to make sure that formatting the flash and deleting everything is really what you want to do. Select OK to format the internal flash memory. Select CANCEL if you do not wish to proceed.

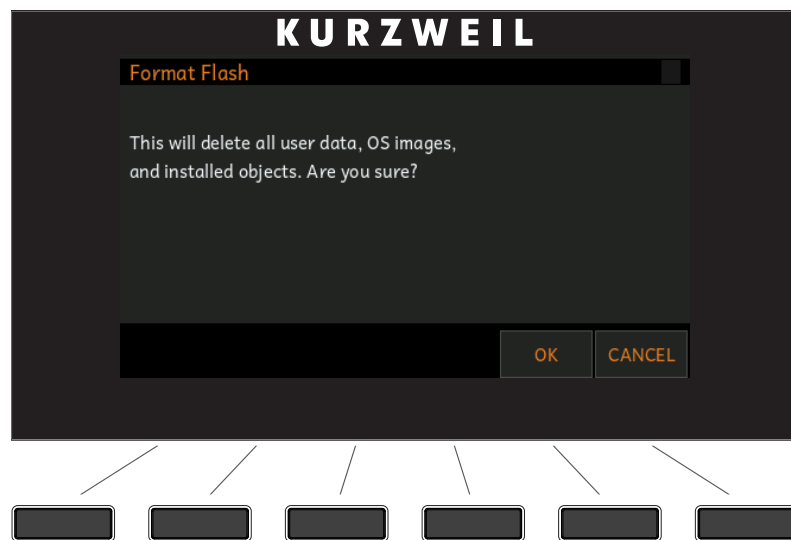

## System Mode

---

### System Utilities

- When formatting of the internal flash memory is completed, the display will show the message “Done formatting flash.”. Press OK.

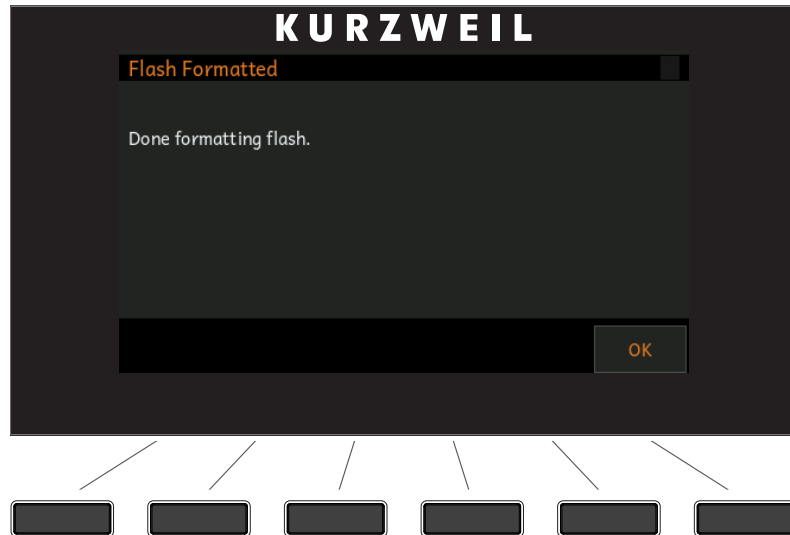

## Install Module

This option allows the installation of individual files. You may be guided by Kurzweil Technical Support to use this option if needed.

## Restore Older

If you have updated the Forte but wish to return to the earlier version, you can use the Restore Older option.

## Display Diag

This option allows diagnostics of the color LCD display. You may be guided by Kurzweil Technical Support to use this option if needed.

# Chapter 13

## Troubleshooting

### Maintenance

Aside from normal care in handling and use, your Forte requires no regular maintenance. Clean with a soft dry cloth. Never use abrasives or solvents as they may damage the unit's paint, markings, and display screen. There are no batteries inside to replace—ever. Instead of volatile SRAM used in most other instruments, your Forte uses nonvolatile Flash Memory for storage, which retains information without power.

### Common Problems

Below is a list of the most commonly encountered problems and diagnoses for each.

#### Power Problems

This is the normal power-up sequence:

1. The display backlight turns on.
2. “Loading...” appears on the display for a few seconds.
3. The Forte enters Program Mode with Program 1 selected, or the Program that was selected the last time Global mode was exited.

If nothing at all happens when you turn the power switch on, check if one of the following might be the issue:

## Troubleshooting

### Common Problems

<b>ISSUE</b>	<b>The power cable is not plugged securely into the wall outlet.</b>
<b>REMEDY</b>	Plug the power cable securely into the wall outlet.

<b>ISSUE</b>	<b>The power cable is not plugged securely into the Forte power jack.</b>
<b>REMEDY</b>	Plug the power cable securely into the Forte power jack.

<b>ISSUE</b>	<b>The wall outlet, power strip, or extension cord is defective or damaged.</b>
<b>REMEDY</b>	Use a different wall outlet, power strip, or extension cord.

If there's evidence of the unit receiving power, but operation is abnormal, check if one of the following might be the issue:

<b>ISSUE</b>	<b>The wall outlet voltage is below 90 volts due to overload.</b>
<b>REMEDY</b>	Try a different outlet on a different circuit.

## Display “Brightness”

<b>ISSUE</b>	<b>The Display is blank or difficult to read.</b>
<b>REMEDY</b>	Slowly turn the Display brightness knob (located above the Navigation buttons) to adjust the Display.

## Audio Problems



**CAUTION:** Do not troubleshoot audio problems using headphones. Additionally, always be aware of the volume levels on the Forte and on the connected audio system or mixer.



**NOTE:** When diagnosing audio problems, set the Forte to play a Song Demo rather than intermittently pressing keys. This will prevent any unexpectedly loud volume changes.

If there is no sound from your Forte, check if one of the following might be the issue:

<b>ISSUE</b>	<b>The volume slider is turned down.</b>
<b>REMEDY</b>	Slowly push the volume slider up.

<b>ISSUE</b>	<b>The volume control on the audio system or mixer is turned down.</b>
<b>REMEDY</b>	Slowly turn the volume control up.

<b>ISSUE</b>	<b>The signal source selection on the audio system or mixer is incorrect.</b>
<b>REMEDY</b>	Set the volume of the audio or mixer to the lowest level, select the correct signal source, and then slowly turn up the volume.

<b>ISSUE</b>	<b>The audio cables are not securely plugged into the Forte, audio system, or mixer.</b>
<b>REMEDY</b>	Set the volume of the audio or mixer to the lowest level, securely plug in the audio cables on both ends, and then slowly turn up the volume.

<b>ISSUE</b>	<b>The Destination parameter stops MIDI Data.</b>
<b>REMEDY</b>	Change the Global Mode (MIDI page) "Destination" parameter to USB+MIDI+LOCAL (see page 9-11)

<b>ISSUE</b>	<b>The audio cable is of an incorrect type.</b>
<b>REMEDY</b>	Obtain and securely connect an audio cable of the correct type. The Forte accepts both balanced (TRS) and unbalanced (TS) 1/4-inch audio cables.

## Troubleshooting

---

### Common Problems

If you can hear sound but it is low or distorted, check if one of the following might be the issue:

<b>ISSUE</b>	<b>A received MIDI volume message has specified a low volume.</b>
<b>REMEDY</b>	Set the volume of the audio system or mixer to the lowest level. Disconnect all MIDI cables, set the “Destination” parameter in Global Mode (MIDI page) to LOCAL or USB+MIDI+LOCAL and reset the volume level on the Forte, by pressing Panic (see page 3-17). Finally, slowly turn up the volume level of the audio system or mixer.

<b>ISSUE</b>	<b>The current Multi has another controller assigned to volume, and it is turned down.</b>
<b>REMEDY</b>	Select a different Multi. Or change the problematic controller setting by editing the Multi in Multi Edit Mode.

<b>ISSUE</b>	<b>The audio system input is set for low impedance instead of high impedance.</b>
<b>REMEDY</b>	Set the volume of the audio system or mixer to the lowest level, change the impedance setting, and then slowly turn up the volume of the audio system or mixer.

<b>ISSUE</b>	<b>The input trim to the audio system or mixer is set too low.</b>
<b>REMEDY</b>	Slowly turn up the trim.

## MIDI Problems

If you are experiencing problems sending MIDI to an external module, check if one of the following might be the issue:

<b>ISSUE</b>	<b>The MIDI cable is not securely plugged in at both ends.</b>
<b>REMEDY</b>	Securely plug in the MIDI cable at both ends.

<b>ISSUE</b>	<b>The MIDI connections are wrong.</b>
<b>REMEDY</b>	To send MIDI, plug the MIDI cable into the Forte's MIDI Out port and into the module's MIDI In port.

<b>ISSUE</b>	<b>The MIDI cable is defective.</b>
<b>REMEDY</b>	Obtain and securely connect a new MIDI cable.

<b>ISSUE</b>	<b>The MIDI transmit channel does not match that of the receiving device.</b>
--------------	---

If there are problems with the internal sound module receiving MIDI from an external device like a computer sequencer, check if one of the following might be the issue:

<b>ISSUE</b>	<b>The MIDI transmit channel of the transmitting device does not match that of the receiving Program or Zone on the Forte.</b>
<b>REMEDY</b>	Change the channel on either the Forte or on the computer such that the channels match.

<b>ISSUE</b>	<b>The MIDI cable is not securely plugged in at both ends.</b>
<b>REMEDY</b>	Securely plug in the MIDI cable at both ends.

<b>ISSUE</b>	<b>The MIDI connections are wrong.</b>
--------------	--

# Pedal Problems

Before you consult this section, be sure to read The Pedal Jacks on page 2-7:

## Switch Pedal Problems

If you are having problems with connecting or using a switch pedal, check if one of the following might be the issue:

- Sustain or Sostenuto is stuck “on”. Be sure the pedal is plugged in before switching on the power. Turn power off, then on, if necessary.
- The pedal is acting backwards (“on” when up instead of down). Power cycle the unit making sure to NOT press on the pedal during startup.

## If None of the Above...

If your problem is not covered above, or if none of the suggestions seem to work, first check back and review the relevant sections of this manual. Many difficulties are just programming problems caused by settings of Multi parameters. If you want to be sure that all of the factory defaults are in place, see Restoring Factory Defaults on page 11-7.

Also be sure to check Kurzweil's website for additional Forte information that may have been published since this manual was written: [www.kurzweil.com](http://www.kurzweil.com).

If you still have problems, contact Kurzweil support in your country or at [www.kurzweil.com/support/](http://www.kurzweil.com/support/). You may also find unofficial help at some of the internet communities listed at [www.kurzweil.com/community/](http://www.kurzweil.com/community/).

### Service Centers

Contact the nearest Young Chang office Kurzweil service representative. See page iv in the front of this manual for contact information.

## Restoring Factory Defaults

For restoring your Forte back to the factory defaults, see Global Mode Reset on page 10-21



**CAUTION: Restoring factory defaults cannot be undone. Back up your files before doing so by following the procedure on page 12-5**

## Diagnostics

You will most likely not need to use the System Mode diagnostic operations in normal cases. These operations are mostly used at the factory and service centers by engineers for troubleshooting hardware problems. But, in some cases you might be required to run these diagnostics for troubleshooting and diagnosing symptoms. In these cases, follow the direction of an authorized Kurzweil technician.

# Appendix A

## MIDI Implementation

Function		Transmitted	Recognized	Remarks
<b>Basic Channel</b>	Default	1	1	Memorized
	Changed	1–16	1–16	
<b>Mode</b>	Default	Mode 3	Mode 3	Use Multi-track mode (see FX Mode (Global Mode) on page page 10-4 for multi-timbral applications)
	Messages			
	Altered			
<b>Note Number</b>			0–127	
	True Voice	0–127	0–127	
<b>Velocity</b>	Note ON	O	O	
	Note OFF	O	O	
<b>Aftertouch</b>	Keys	X	O	
	Channels	O	O	
<b>Pitch Bender</b>		O	O	
<b>Control Change</b>		O 0–31 32–63 (LSB) 64–127	O 0–31 32–63 (LSB) 64–127	Controller assignments are programmable
<b>Program Change</b>		0 to 2,097,151	0–511	Standard and custom formats
	True #	0–127	0–127	
<b>System Exclusive</b>		O	O	
<b>System Common</b>	Song Pos.	X	X	
	Song Sel.	X	X	
	Tune	X	X	
<b>System Real Time</b>	Clock	O	O	
	Messages	O	O	
<b>Aux Messages</b>	Local Control	O	O	
	All Notes Off	O	O	
	Active Sense	X	X	
	Reset	X	X	
<b>Notes</b>		Manufacturer's ID = 07 Device ID: default = 0; programmable 0–127		
<b>Mode 1: Omni On, Poly</b> <b>Mode 3: Omni Off, Poly</b>		<b>Mode 2: Omni On, Mono</b> <b>Mode 4: Omni Off, Mono</b>		O = Yes X = No

# Appendix B

## Physical Specifications<sup>1</sup>

<b>Keyboard:</b>	88-key, fully-weighted hammer-action with velocity and pressure (After Touch) sensitive adjustable keys. 88-key model uses Fatar TP/40L with pressure.
<b>Display:</b>	480 x 272 pixel high resolution color LCD with front-panel brightness adjust.
<b>Polyphony:</b>	128 Voice Polyphony, dynamically allocated.
<b>Multitimbral:</b>	16 parts (one per MIDI channel).
<b>Quick Split / Layer:</b>	Easy access with adjustable volume and panning.
<b>Programs:</b>	321 Factory plus 1024 User Programs.
<b>Multis:</b>	186 Factory Multis, plus 1024 User Multi locations with 4 programmable zones for splits and layers.
<b>Effects:</b>	Hundreds of complex effect chains, incorporated into programs. Chains are not editable, but insert and aux chains can be selected.
<b>Controllers:</b>	<ul style="list-style-type: none"> <li>• Pitch wheel</li> <li>• Modulation wheel</li> <li>• Volume Slider</li> <li>• 9 front panel sliders with LED ladders</li> <li>• 9 switches (assignable / zone mutes / KB3 control)</li> <li>• 1 Variation switch</li> <li>• 1 Tap Tempo switch</li> <li>• 5 Master EQ/Compressor Knobs</li> <li>• 2 EQ/Compressor On/Off Switches</li> <li>• 3 switch pedal inputs, each supporting single switch pedal or single half damper pedal.</li> <li>• 2 continuous control pedal inputs</li> <li>• 2 Transpose buttons</li> </ul>
<b>Analog Outputs:</b>	<p>Four 1/4" TRS Balanced Outputs (Two Stereo Pairs, A &amp; B)            24-bit D-to-A Converters            Frequency Response 20Hz-20kHz +/- 0.1dB            +21dBu Maximum Output Level            -113dB Signal-to-Noise Ratio (A-weighted)            0.003% THD+N (1kHz @ -1 dBFS)</p>
<b>Headphones:</b>	<p>1/4" Front-Mounted Stereo Headphone Output            Frequency Response 20Hz-20kHz +/- 0.5dB            Maximum Output Power 130mW into 32 Ohms            -100dB Signal-to-Noise Ratio (A-weighted)            0.03% THD+N (1kHz @ 100mW Output into 32 Ohm Load)            Output Impedance: &lt; 1 Ohms            Load Impedance: &gt; 24 Ohms</p>
<b>MIDI:</b>	IN, THRU (Switchable to OUT), OUT
<b>USB:</b>	<p>Complete MIDI functionality over USB            User Program / Multi file transfer to/from PC / Mac / Tablet/ USB Flash Drives.            Operating System updates from PC / Mac / USB Flash Drive</p>
<b>Height:</b>	5.5" (14 cm)
<b>Depth:</b>	15.5" (39.5 cm)
<b>Length:</b>	54.5" (138.5 cm)
<b>Weight:</b>	48 lbs (21.77 kg)
<b>Power:</b>	Internal switch-mode power supply 100-240 VAC, 50/60 Hz, 300mA (20W max)

<sup>1</sup> Specifications subject to change without notice

# Appendix C

## Programs

Object Version : 1.21.00

ID	PIANO	ID	PIANO
1	Rich 9ft Grand	17	70's Album
2	Rich 7ft Grand	18	Artis Grand
3	Bright 9ft Grand	19	Legacy Grand
4	Bright 7ft Grand	20	New Age
5	Solo 9ft Grand	21	Piano & Harp
6	Solo 7ft Grand	22	Piano & Choir
7	Vintage Upright	23	Mood Ring
8	Vintage Grand	24	Ambience
9	Elegant Grand	25	Film Piano
10	New Orleans	26	Soul Piano
11	Dark & Distant	27	Pub Piano
12	Piano & Pad	28	Double Grand
13	Piano & Strings	29	Mono Upright
14	Punchy Edge	30	Double Squash
15	R&B Stack	31	Vintage Squash
16	SuperPop	32	House Piano

ID	E. PIANO	ID	E. PIANO	ID	E. PIANO
33	Rooftop 73 Rhds	50	Phase Dist Wurly	67	RoyalKingWakeman
34	Steely Dyno 77	51	Bright Fuzz Wrly	68	StageTines Soft
35	Vintage Amp Wrly	52	Tramp Amp Wurly	69	Suitcase Tines
36	Amped Bell 73	53	FM EP 1	70	RealTouch73 Suit
37	BarkDist 77 Rhds	54	FM EP 2	71	RealTouch77 Suit
38	Beck'sRetroWurly	55	Rhotary Rhds '73	72	RealTouch Wurly
39	Phasey 73 Rhds	56	Elec Grand Stack		
40	Mr. SparkleTop73	57	BrightRMI Pn/Hrp		
41	Aged Tolex 77	58	Tight Bright FM		
42	Smooth 70s 73	59	Gabriel's Melt		
43	FusionChorDyno73	60	CP80 Enhanced		
44	Chorus 77 Rhds	61	VideoKilledRadio		
45	73/77StereoBells	62	UK Pop CP70		
46	Env Filt 73 Rhds	63	MistyMountain EP		
47	Ray's Wurly	64	No Quarter Pnt		
48	Deep Fuzz Wurly	65	Black Friday		
49	T-Bone Wurly	66	Sly Ballad		

## Programs

---

ID	CLAV	ID	CLAV
73	Chaka Clav	81	Fr Harpsi L84U8
74	SupaStevie(CB)	82	Fr Harpsi L48
75	Funkadelic Relic	83	Fr Harpsi Lute
76	ZEP Clav	84	Fr Harpsi L8
77	HeartbreakerWAH	85	Fr Harpsi U8
78	Chameleon Wah	84	Fr Harpsi L8
79	Stevie Fuzz Amp	85	Fr Harpsi U8
80	OutOfPhasPickups		
ID	ORGAN	ID	ORGAN
89	Classic B3	105	All Stops
90	Funky Perc	106	AllStops AllVox
91	Soul Perc	107	Pipe Stops
92	First Three	108	Chapel Organ
93	PerfectStrangers	109	Pipes & Voices
94	70s Drawbars	110	16' Open Flute
95	Progbars	111	16' Ped Reed
96	Ezra II	112	16' Reed A
97	Ezra's Burner	113	16' Viol
98	Classic Traffic	114	LateNighter
99	Mr Smith	115	Testify
100	HotTubeGospel	116	The Ninth Bar
101	VASTBars1-3,8&9	117	Blues Harmonica
102	Doors Vox	118	ParisCmboAccordn
103	Animals Vox	119	MellowAccordion
104	Farfisa	120	BrazilAccordion
		327	Magic Carpet B3
ID	LEADS	ID	LEADS
121	Press Lead	131	Minipulse 4Pole
122	Cars Square Lead	132	FrankensteinWah
123	Keytar Hero(Wah)	133	Candy*O SyncLead
124	Voyage Lead	134	Raw & Bleedin'
125	SimpleHipHopLead	135	Dist Filter Lead
126	SquareChirpLead		
127	Vector Lead		
128	80's Lead Synth		
129	Dark Wobbles		
130	Daft Lead		

ID	PADS	ID	PADS
137	Film Score Pad	146	Lush Pad
138	Majestic Pad	147	Deeper Water
139	So Lush Pad	148	Lush Rhythm Pad
140	Bladerunner ARP	149	Cosmic Sus Pedal
141	CrotaleScape Pad	150	Slo Syn Orch
142	Undercurrents	151	Add A Pad 1
143	Fairlight Pad	152	Add a Pad 2
144	Phase Shimmer	330	Reverse Universe
145	Evolving Pad	331	Pan Strings 3
		332	5th-Scape
ID	SYNTHS	ID	SYNTHS
153	Super Saw	161	Big Old Jupiter
154	Bright Vector	162	Punchy Synth
155	Classic SynBrass	163	Touch Trance
156	MW S&H Filt	164	Square Bell
157	80's Heaven	165	Perc Vector
158	PolySynth Stack	166	Tesla Coil
159	Chillwave Chords	167	Warbly Pong SQR
160	Classic Saws	168	Gangsta Wrap
		340	SyncoDeMayo
ID	SYNTH BASS	ID	SYNTH BASS
169	Woodhouse Bass	176	Noise Bass
170	Aggro OctoBass	177	The Way It Is
171	KneeDeepMinimoog	178	Dolby Bass
172	Squeeze Mini	350	Leviathan Bass
173	Iceman Bass	351	Decepticon Bass
174	ANGRYBass	352	Latch Bass
175	Big Synth Bass	353	APG-ish Bass
ID	STRINGS	ID	STRINGS
179	Adagio Strings	187	Full Pizzicato
180	Big LA Strings	188	Lead Violins II
181	Fast Strings	189	AggressDivisiStr
182	Slow String Trem	190	Yeesis Tron Str
183	AdagioTutti 8ves	191	Moby TurntblTron
184	Adagio Octaves	192	Solo Violin fast
185	NashvilleStrings	193	Solo Cello fast
186	Poltergeist Pad	194	Arpegg/Solo Harp

## Programs

---

BRASS		BRASS	
195	Session Hornz	203	Lead Trumpet
196	High-End Horns	204	Solo Trombone
197	Split SectionSW	205	Jubilee Trumpets
198	Mancini Brass	206	Wah Trumpet
199	GB Hornz+Syn	207	Mr. West Horns
200	Super-8 Brass	208	Bullit Brass
201	Brass Fanfare	209	Dr. StAb'N SwEll
202	Low Orch Brass	210	MiamiBrassSectns
WINDS		WINDS	
211	Mostly Saxes	215	Solo Tenor Sax
212	UniSaxSection	216	Clarinet/Flute
213	Bassoon/Oboe	217	Solo Bari Sax
214	Solo Alto Sax	218	StrawberryFlutes
ENSEMBLE			
219	Gothic Climax		
220	Winds & Strings		
221	3Way Split Mltrn		
GUITAR		GUITAR	
227	Rich 'Caster	235	SuperflyWahCast
228	Rich Les	236	Jack the Ripper
229	Studio 'Caster	237	Boutique Six Str
230	Phase Pick Les	238	Boutique 12 Str
231	TimeWarpCaster	239	Real Nylon
232	Kinda Krunchy	240	Mandolin Plus
233	Brown Sound	241	Banjo Plus
234	Stompbox Les	242	Dulciliere
BASS		BASS	
243	P-Bass	247	Jaco Fretless
244	Motown Bass	248	AC Buzzer Bass
245	Finger Bass	249	Beasties Bass
246	Flea/Bootsy	250	Levin/GabrlFrtls

DRUMS		DRUMS	
251	Kit 1 Open Rock	259	Kit 9 Big Buzz
252	Kit 2 J Geils	260	Kit 10 DeadRockr
253	Kit 3 West Boxy	261	Kit 11 Low Rock
254	Kit 4 SquashRock	262	Kit 12 GaddsLair
255	Kit 5 Beatbox101	263	Kit 13 KirkeeB
256	Kit 6 Full Room	264	Kit 14 ModernRok
257	Kit 7 Brush	265	Kit 15 Drum&Bass
258	Kit 8 CopperRing	266	Kit 16 Skrlx
PERCUSSION		PERCUSSION	
267	Celeste	274	Percussionist
268	Octave Celeste	275	BongoConga
269	Bells	276	TalkingDrum
270	Carillon	277	Perc Accessory
271	Basic Orch Perc	278	Carnival Perc
272	Orch Timpani	279	Vocal Percussion
273	Natural Perc	280	Rogers Celeste
VOICES		VOICES	
283	Mixed Choir	291	Slo Orch Chorus
284	Manhattan Voices	292	Aaah Vocals
285	Choir Complete	293	Jazzy Ballad Vox
286	NYC in LA	294	Bright Syn Vox
287	Crystal Voices	295	AntiqueAhhChorus
288	Cathedral Vox	296	Vox Orgel
289	Silent Sorrow	297	Aaahlicious
290	Swept Tron Voice	298	PolyTechnobreath
MALLETS		MALLETS	
299	Glockenspiel	304	Chimes
300	Real Vibes	305	Bigger Chimes
301	Stereo Marimba	306	Crotales Hits
302	Xylophone	307	Metal Marimba
303	XHarmonicStlDrum	308	SteamPunkMallets
		309	CelesteGlockHarp

## Programs

---

<b>ID</b>	<b>HYBRID</b>
315	Celeste Palette
316	Bellestrum VTrg
317	Toy Piano
318	Bunch of Bells
319	Synthy 73
320	Wurzzicato
321	Comp Cro + Pad
322	Clavestrum
<b>ID</b>	<b>MISCELLANEOUS</b>
323	Bowed Crotales
324	Bells and Bows
325	Bass Pedal
326	Bubbles!
997	Silent Program
998	Editor Template
999	Clear Program

# Appendix D

## KB3 Programs

### Introducing KB3 Programs

There's nothing quite like the sound of the classic Hammond™ B-3 tone wheel organ, especially when played through a Leslie™ rotating speaker system. We've done extensive testing and analysis with several tone wheel organs, and created our own models to emulate the unique tone wheel sound. We even took into account the way that older organs start to sound different (and arguably better) as their capacitors begin to leak—and we included a parameter that varies the amount of grunge (leakage) in your sound.

#### First Some History

Countless blues, jazz, and rock recordings have centered around the distinctive sound created by classic tone wheel organs (such as the Hammond B-3) played through rotating speaker systems like the Leslie. Not only is the sound great, but it's supremely versatile, since the player can control timbre in real-time by adjusting drawbars that add or remove harmonics from the fundamental tone. Other cool sound-shaping tools include a percussive emphasis that can be added to each note and the capability to change speaker rotation speed. Many people, in fact, feel that the tone wheel organ was the first popular synthesizer. And although these organs haven't been made for years, they are still sought after, restored, and lugged about by legions of dedicated keyboard players. This despite archaic electronics, inscrutable wiring, and an unwieldy heft that tops 400 pounds.

Duplicating the sound and flexibility of these organs – without the nasty side effects – is the goal of KB3 Mode.

#### KB3 Improvements in the Forte

KB3 Programs in the Forte contain improvements over previous Kurzweil models including improved Leslie emulation Chains, Key Click, Leakage, and cabinet emulation.

Also, KB3 programs that emulate Hammond organs do not use any of the Forte's 128 voices of polyphony (this does not apply to KB3 Programs that emulate Vox or Farfisa organs).

## Drawbars

The drawbars on a tone wheel organ emulate pipes of different lengths on a pipe organ. In either case, they are controlled by changing the positions of a number of “stops”. As the organist pulls out or pushes in these stops, he adds or reduces harmonics. Whether it’s pipes or drawbars, though, the stops work like this: pull one out to add more of an overtone; push it in to reduce the volume of the overtone.

The stops on the most popular tone wheel organs are: 16’, 5 $\frac{1}{3}$ ’, 8’, 4’, 2 $\frac{2}{3}$ ’, 2’, 1 $\frac{3}{5}$ ’, 1 $\frac{1}{3}$ ’ and 1’. Note that they are still measured in feet, a carryover from pipe organ days. The 16’ and 5 $\frac{1}{3}$ ’ stops are considered the subharmonic group, while the third stop, 8’, produces the fundamental of a tone, and stops 4-9 produce harmonics above the fundamental. By making use of different combinations of these harmonics, a rich sort of additive synthesis is possible. Best of all, you can make radical changes to the tone dynamically as you play.

The nine sliders of the Forte are set to control the drawbars, as listed in blue below the sliders. Pulling the slider towards the keyboard increases the amount of the drawbar that is heard.

## KB3 Mode Buttons

The nine buttons above the sliders on the Forte have special capabilities in KB3 Mode that are listed in blue, below the Multi Zone Mute Buttons and Programmable Switches. These are:

### Brake

Brake starts and stops the rotary speaker effect. This effect is not immediate, instead the rotary speaker effect gradually slows down and speeds up, in a similar way that a real rotary speaker reacts.

### Chorus/Vibrato

#### On/Off

This parameter turns the chorus or vibrato effect on and off.

#### Chor/Vib

This parameter determines which modulation effect is used. The choice is Vibrato or Chorus

### **Chorus/Vibrato Depth**

This parameter determines how much of the effect is applied to the KB3 sounds. There are two levels of both Chorus and Vibrato available, depending on the setting for the Chor/Vib button.

## **Percussion**

Percussion is a characteristic feature of tone wheel organs. It's especially useful while soloing, since percussion adds an extra plink (actually an extra tone at a defined harmonic) to the attack of individual notes. When you play more than one note simultaneously, only the first note you play will trigger the envelope of the percussion tone, though notes played shortly afterwards will also be affected by this envelope. When you play chords, all of the notes played simultaneously will get the percussive effect (provided percussion hasn't already been triggered.)

### **Percussion On/Off**

This is where you turn the percussion effect on or off. Percussion is created by a decaying envelope applied to one of the nine drawbars (usually the 4th drawbar for the low pitch and the 5th drawbar for the high pitch. The highest drawbar is normally stolen to generate the percussion sound). The percussion effect is "single-triggered", which means that once it's triggered, it won't trigger again until all keys go up.

The KB3 engine in the Forte is capable of generating the Percussion effect without stealing any of the drawbars, and while not authentic, is occasionally used on Forte Programs.

### **Percussion Loud/Soft**

This parameter switches between loud and soft percussion settings.

### **Percussion Decay F/S**

This parameter switches between fast and slow percussion settings.

### **Percussion Pitch H/L**

This parameter switches between high and low harmonic percussion settings.

## **KeyClick**

The Key Click feature adds a decaying burst of pitched noise to the attack of notes. Unlike the percussion, the key click is "multi-triggered", which means that every new note will trigger it.

This button controls whether the Key Click parameter is switched on or off.

## Variation

The Variation button acts as a Slow/Fast switch for the Rotary speaker effect. By default, the sustain pedal (SW1) also controls Rotary Slow/Fast. You can set the sustain pedal to function as sustain for all KB3 Programs (instead of Rotary Slow/Fast) by using the Rotary Override parameter in Global mode. You can also make different Rotary Slow/Fast controller assignments for each Program or Multi by using the Parameters page in Program Edit Mode or the Multi Controls page in Multi Edit Mode.

# Appendix E

## Multis

Object Version : 1.21.00

1	Gospel B3 & Pno	ID	MULTI	ID	MULTI
2	Min Ho Worship	36	Endless Dream	71	Controlled Synth
3	Celestial Palace	37	EP & Synbass	72	FM-Disco Pop
4	Universe Pad	38	Chill Kit/Chords	73	Bossa Me
5	Triumphant!	39	Daydream EP	74	Prepared Marimba
6	Massive Mono	40	Big Choir 5ths	75	EBass/FMEP & Pad
7	Sea Breeze	41	Plucked Sus Strs	76	Cool Vibes
8	The Shire w Oboe	42	Alien Choir	77	Funked Up MWheel
9	Futurescape	43	Synth & Strings	78	Harpsichord&Orch
10	Vox n Glox	44	Pizz & Glock	79	BaroqOrgan&Strgs
11	Jazz Combo Split	45	Burning Lead	80	E Bass/B3 Perc
12	Triggered Comper	46	Jungle Marimba	81	Dual Manuals
13	Blues Harp Jam	47	ClavWithBenefits	82	Tron Vox/MW Tron
14	Trancendental	48	Introspektakular	83	Multi Percussion
15	MassivePitchBend	49	Pad Organ	84	Open Doors
16	Parisian Night	50	Organ and Rhodes	85	Keyboard Arsenal
17	Acid Brass Group	51	Choir Beckons	86	Shimmering Pad
18	BaroquePipeOrgan	52	The 9th Circle	87	Clav Lead
19	Mwl SuperStrings	53	Celestial Mallet	88	Trumpet/Flute
20	Cloudwalk Keys	54	Bellsy Galore	89	LiteBrite
21	Glitter Glue	55	Mohawk Monophono	90	Distorted Keys
22	Hollow Keys	56	Lefty Rhds/B3	91	Maximalist Organ
23	Liquid Pad	57	Composite EP	92	Multi Strings
24	Sus Pedal Rave	58	Far Out EP	93	Multi Harpsichrd
25	Gtr/Bass Ballad	59	Dreamy Piano	94	Fierce Mono Lead
26	Quad Pad	60	Folk String Band	95	PolySaw Synth
27	Piano, Steel+Pad	61	Hybrid Pad/Lead	96	Spider's Silk
28	Funky Bass Split	62	VelBrassSalsaJam	97	Fairy Tale Glock
29	Cartoon Pizz	63	Rock On!	98	Epic Pad
30	Hip Hop Thirds	64	ABs/Brs & MWStrg	99	Plucked Ambience
31	Loaded Switches	65	BsKik&Snare\Orgn	100	Dubly Bass&Piano
32	Euro Chords	66	Vel Orchestra	101	Betty Boop
33	Distorted Stack	67	Dream Catcher	102	70's Prog Fusion
34	CP, FM & Pad	68	Strummer	103	EnvloProg Fusion
35	Piano +Gtr +Pad	69	70's Ballad	104	Rhodes Surprise
35	Piano +Gtr +Pad	70	80's Power Rock	105	Piano Trio Ped2

## Multis

---

ID	MULTI	ID	MULTI	ID	MULTI
106	Pedal Drummer!	145	Aero Dream	254	Layer Default
107	EP & Pedal Pads	146	Str/Cel/Vox/Glok	255	Forte Control
108	3Octave Pno/Bass	147	Sparkler	256	Clear Multi
109	Piano Vel Brass	148	Guitar+Synth		
110	Rhode Sweetness	149	Neo-Baroque		
111	Double Drummer	150	Dirty Funk Split		
112	VelocityBell Pad	151	Mystical Synth		
113	Piano Lesson	152	Stacked Organ		
114	Fuzzy Wurly/Bass	153	Glitzy Keys		
115	Trem Wurly Layer	154	Phat Horns		
116	Clavinorgethizer	155	Buggin Bells		
117	Quad Stack 1	156	Breathy Synth		
118	Quad Stack 2	157	Clean Lead		
119	MW Orch Strings	158	Piano+Strings		
120	Cathedral Organ	159	SlurpyPad-O		
121	BaroqueEnsembles	160	DramaPad		
122	PipeOrgnVox&Orch	161	Mercury Rise		
123	Island Girl	162	Static Pad		
124	Ice Age	163	Windy City		
125	Janet's Strut	164	Square Coil		
126	Windy Pad	165	French Nylon		
127	Wurly/Horns	166	Psychedelic Pad		
128	Vocal Organ	167	Floating Pad		
129	Full Blast Horns	168	Brass Pad		
130	Clocks	169	String Pad		
131	Enchanted Forest	170	Large Choir		
132	Sleepy Hollow	171	Medieval Ages		
133	Klezmer	172	Gamelan		
134	Kurzland Report	173	Pure Imagination		
135	Why Am I Here?	174	DnB Split		
136	Voyager	175	Dub Reggae		
137	Year oftheDragon	176	Toxic Split		
138	Bring It MW	177	Jazzy Key Trigs		
139	Reflections	178	Motion Synth/Pad		
140	Hybrid Clavier	179	SloStrCelesta		
141	Gabriel's Keys	180	SloStr/Cel/Rhds		
142	Boz Low Down	181	Disklosure Split		
143	Prog Split	182	Game ofTrombones		
144	Don't Stop	253	Split Default		

# Appendix F

## Effects

Object Version : 1.21.00

ID	EFFECT	ID	EFFECT	ID	EFFECT
1	Little Booth	34	Soft Flange	67	Reverse Reverb
2	Soundboard	35	Wetlip Flange	68	Reverse Reverb 2
3	Small Dark Room	36	Flanged Taps	69	Oil Tank Reverb
4	Sax Chamber	37	Slow Deep Phaser	70	Laser Reverb
5	Small Hall	38	Fast&Slow Phaser	71	Gated Laserverb
6	Medium Hall	39	Phaser EGT	72	ReverseLaserverb
7	Green Room	40	Thin Phase Sweep	73	Envelope Followr
8	Opera House	41	Tremolo BPM	74	Envelope Filter2
9	Real Nice Verb	42	Simple Panner	75	Trip Filter
10	Empty Stage	43	Thin Phase Sweep	76	Stereoizer
11	Med Drum Room	44	Leslie start	77	Barberpole Phzr
12	AbbeyPianoHall	45	SubtleDistortion	78	Laser Dly Reverb
13	Predelay Hall	46	EPiano Distortzn	79	Degenerator
14	Sweeter Hall	47	Distortion + EQ	80	Basic Delay 1/8
15	Concert Hall	48	Ray's EP	81	Arp Delay Loop
16	Symphony Hall	49	Scooped Distort	82	HipHop Piano DDL
17	Cathedral Chorus	50	Burning Tubes!	121	Sly Leslie K
18	DeepChorsDlyHall	51	3BandDrumComp	129	Basic Delay 1/8
19	Omni Stage	52	Snare Compressor	147	Deeper Water
20	Classic Plate	53	Snare Cmp w/Rvb	176	Lead EGT6
21	MediumWarm Plate	54	Kick Compressor	193	LitePad2
22	Real Plate	55	Hard Knee Compr	203	PhaseDly1
23	Smooth Plate	56	Bass Comp Mutrn	204	ThinphaseSweep
24	Gated Plate	57	PnoEnhancement	206	hhpitchr1
25	Basic Delay 1/8	58	LA2A for Strings	209	Snarcmp1
26	4-Tap Delay BPM	59	Resonant Filter	210	SymphonyHall 1
27	Echo Plecks BPM	60	Aux Echoplex	211	SymphonyHall 2
28	Timbered Taps	61	Bandsweep Filter	212	SymphonyHall 3
29	Dub Delay	62	Hi FrequencyStim	213	Jazz Stage
30	Sm Stereo Chorus	63	Ring Modulation	214	Live Room
31	Chorusier	64	Frequency Offset	215	String Chamber
32	Stereo Chorus	65	Lazer Tag Flange	216	Fife Stage
33	Dense Chorus	66	Fallout PitchLFO	217	Live RecitalHall

## Effects

---

ID	EFFECT	ID	EFFECT	ID	EFFECT
218	AbbeyBrasHall2	273	OmniStage	331	Warm Leslie K
219	Smooth Long Hall	274	OmniStage	332	NewLord 1 K
220	kickcmp3	275	gshot vrb	333	CrunchLesl122 K
223	kickcmp4	276	deep part1	334	HotLeslie122b K
224	snarcmp4	277	DbISloFlangeCmp	335	BostonLeslieK
226	kickcmp5	278	alphacentauri1	336	CrunchLesl122 K
229	Bright Hat Room	279	Timbered Taps 2	337	Hot Leslie 122e
230	BrightFlange	300	GospelDistLes K	338	HotLeslie122f K
233	snarshaper6	301	GimmeSumLeslieK	339	Soul Leslie122 4
240	Reverb2	302	DF OrganRoom	340	Leslie B 122 K
241	500msDelay K	303	GimmeSomeLesl	341	JoeyLeslie122 K
242	Organ Chamber1	304	GimmeSomeLesl2	342	HotLeslie122g K
243	TapChorusLes LE2	305	500msDelay K	343	HotLeslie122h K
244	Organ Latch 1/8	306	Organ Chamber1	344	TapChorusLes K
245	Organ Phaser	307	Organ Latch 1/8	345	SlwPhasdLeslieK
246	Organ CDR 1	308	Organ Phaser	363	NonKB3 A K
247	nuLeslie122K	309	Organ CDR 1	364	Warm Leslie12 K
248	Mitch's Leslie K	310	AcceleratLes2 K	365	WrmDstlLes1dwK
249	TapChorusLes K2	312	ExpressLeslie K	366	BrighDistlLes1K
255	Flange+Delay	313	Leslie 122 a K	367	DistleratLes6 K
257	Empty Stage II	314	Mitch's LeslieK	368	BrightDistlLesK
258	AbbeyPianoHall 2	315	Melvin'sLeslieK	369	DistlLes HotGs
259	Opera House II	316	Greg's Leslie K	370	Prog Leslie1K
260	Vintage Strings2	317	RoomyLeslie122K	371	LightDistlLes2K
261	Classic Plate II	318	SoftLeslie122 K	372	DW Leslie13 K
262	Recital Hall II	319	CrnchLesli147 K	373	LeeMichaels 1 K
263	Small Hall II	320	Thimmer Leslie	374	NonKB3 A K
264	Real Niceverb II	321	Jimmy's Leslie 2	375	DWLeslie12 K
265	Medium Hall II	323	Organ Taps	376	DistlLes 5 K
266	Small Dark Room2	324	Leslie Clean K	377	Sly Leslie K
267	PnoRvb II	325	Leslie 122 K	378	LightDistlLes K
268	ShortPnoRvb III	326	Jimmy'sBrake	379	FisherLeslie
269	PnoEnhancRvb3	327	Jimmy'sBrake K	380	SoulLeslie122 K
270	RevComp5	328	Greg's LatcherK	381	Big Pop PianoCmp
271	Clunker II	329	Nice Leslie K	382	PianoVerb1
272	St CHDly II	330	Clean Leslie K	383	Pro Piano Cmp

ID	EFFECT	ID	EFFECT	ID	EFFECT
384	DistlLes HotGs	423	DrumFatty3	463	CagesRoom
385	NewLord 1	424	Fierce Lead	464	CmpRecitalHall
386	SystemTemp Tap	425	CompTrem	465	StrRecitalHall1
387	WaterDistSynth	426	12StWarmCrunch	466	StrRecitalHall2
388	FlangeVoiceHall	427	Phaser EGT	467	RecitalHall
389	BrightFlangeHall	428	SnareComp1	468	MyJacoART
390	SoulLeslie122 K	429	ASDrumComp1	469	UprightBassRoom
391	FIngRecitalHall	430	KickComp1	470	Levin Chorus
392	Med Drum Room	431	60's BigDrumRoom	472	Bright Room
393	Dual Filters +	432	AS SynthDist2	473	Med Dark Room
394	Dual Filterzz	433	AS CmpVerb4Drms	474	BasicReverb
395	Cathedral Vx	434	AGT EnhCD	477	Medium Hall 4U
396	BurningTubes5	435	CDRecitalHall	478	KickComp2
397	PunchBassAmp	436	Nylon EnhCD	479	ColdPliano 2
399	RevverLeslie	437	RealDrmComp3	480	FDR PercRoom
400	Bradley's Barn 1	439	ChrsDblRoom	482	NylonAgtVerb
401	Bradley's Barn 2	440	EnhcBassAmp	483	3BandDrumComp
403	LA2A for Strings	441	FlangVoiceHall2	484	KikComp 4:1
405	DrmCDR 1	442	Vocals w FXnMic	485	ToxicStrings
406	DrumFatty	443	RealDrmComp4	486	3BandDrumComp2
407	DrumFattyDry	445	Harpolicious	487	Scoopd Dist EGT2
408	AS Drum Room2	446	ChrsDly	488	NotScoopd Dist
409	DrumFattyRoom	447	EGT Hall	489	HeavyBuckers
410	RealDrmComp2	448	Burning Tubes	491	ProBassComp
411	ChrsDly	449	Chorus AGT	492	NYCTripStrings
412	RealDrmComp	450	SynthLead	493	ProBassComp2
413	DrumSlap Sys	451	SynthBassAmp	496	DirtLordAmp LE
414	RealDrmComp2	452	MosqueySwirl	500	Setup Aux Verb
415	TiteDrmComp	454	PadFX2	501	Setup Aux DDL
416	Marimba Hall	455	PadFX1	517	Early Reflection
417	Gated Plate 144m	456	Chr & Echo	518	Pad Depth Pt1
418	AS Dub Delay	457	Vocals w FX	519	Gunshot Verb
419	HipHop Hall	458	DrySynthCDR	520	AlphaCentauri 1
420	AGT Reverb	459	WetSynthCDR	521	BasicCDR
421	Gated Plate2144m	461	VibesRoom	522	Synthorc BPM
422	WarmCruncher	462	PercussionRoom	523	BPM Flange Dly

## Effects

---

ID	EFFECT	ID	EFFECT	ID	EFFECT
524	DbISloFlangeCmp	560	CmPhDiRe4Drms5	603	Gated Plate
525	Deep ChorusVerb	561	JADrumAmp2b	604	JA JazzCmps
526	ChorDlyWet26-28	562	DrmFatener/ Ech2	605	JA RI Nce Verb
527	Light ChorusVerb	563	DrmCMP4PrgFX7	606	JADrumAmp1
528	Chor Delay 26 27	564	EnhCD4DRUMS2	607	JADrumAmp2
529	Pitcher Slider A	565	Little Booth2	608	DrumFXcmpdly1
530	Pad Depth Pt1	566	DrmFIngDlyVrbCm2	609	Drum Freq Offset
531	PolyPitcher 2	567	CmEqDeRe4DrmsSTa	610	CheapDrmDist
532	LFO Pitcher	568	CmEqDeRe4DrmsSTb	611	SynthDist4Drms
533	Wet Hall for Pad	569	DrumFattyDry2	612	DrmCMP4PrgFX4
534	DrmCMP4PrgFX2	570	DrumFattyDry3	613	DrmThnphseSweep
535	Kick Compressor2	571	AS Drum Room2a	614	StereoizerW/Verb
536	Snare Compresso2	572	Gated Plate2144b	615	DrmCMP4PrgFX2
537	DrmCMP4PrgFX	573	DrumFatty4	616	CmPhDiRe4Drms
538	Kick Compressor2	574	DrumFattyRoom3	617	CmPhDeRe4Drms
539	Snare Compresso3	575	ASDrumComp1a	618	CmEqDeRe4Drms
540	Snare Compresso4	576	AS Drum Room2a	619	CmEqDeRe4DrmsST
541	HOP Drum Reverb5	577	DrumFatty3a	620	DrmFatener/ Ech
542	Stereoizer2/Verb	578	AS SynthDist2b	621	DrmPhaseVerb
543	CmPhDiRe4Drms2	579	HipHop Hall2	622	DrmFIngDlyVrbCmp
544	Stereoizer3/Verb	580	AS CmpVerb4Drms4	623	Drum VerbW/Ster
545	Stereoizer5/Verb	581	DrumFattyRoom4	624	Verb/Str/Cmp
546	DrmCMP4PrgFX5	582	DrumFattyRoom5	625	Verb/Str/Dist
547	HOP Drum Reverb5	583	AbbeyBrushHall	626	EnhCD4DRUMS
548	Stereoizer6/Verb	584	HOP Drum Reverb6	627	GatePltPhs3bnd
549	DrmCMP4PrgFX6	585	HOP Drum Reverb7	628	RevVrbFlgV
550	CmPhDiRe4Drms2	586	CmPhDiRe4Drms	629	DrmCMPVb4PrgFX2
551	CmPhDiRe4Drms3	587	DrmFatener/ Ech2	630	3BndCmp4Snr
552	DrumFXcmpdly1a	588	Tuna Hall	631	HOP Drum Reverb1
553	CmEqDeRe4DrmsST2	589	Gated Plywood	632	StereoW/VerbHFD
554	GatePltPhs3bnd2	590	PlywoodDrumFuzz	633	SnrFatener& Ech
555	SynthDist4Drms2	591	AnvilDrumFuzz	634	Warm Drum Plate
556	CmPhDiRe4Drms4	592	Drum Pad Reverb1	635	Dly/vrb BPM
557	DirtLordAmp 2	600	DrumFuzz	636	Drm vrb Long
558	JADrumAmp2a	601	Snare Comp/EQ	637	Real drm plate
559	CmEqDeRe4DrmsST3	602	hhpitchrja	638	Deep Fuzz Vrb

ID	EFFECT	ID	EFFECT	ID	EFFECT
639	Flange+Delay	691	Blueman1	730	BasicChorusDly 2
640	MySynthDist	692	CompDelay12	731	Double Leslie 8
641	DrmphseDlySweep	694	SmallDarkRoom3	732	Wallflower Ch
642	CmDeRe4Drms	695	PlainComp15	733	ChPanDlyComp
643	Sweet drum Hall	696	RevComp4	734	CheeseChorus
644	StevieTrem EP 1	697	EP RotoAmp12	735	Double Leslie 14
645	Beater EP1	700	HiMutron 1	736	CompDelay
646	Jamerson1	701	Sax Chamber 21	737	SynFatener& Ech3
648	SlyBASSComp1	702	BigDarkRoomDW	738	BIGCompDelay
651	Trampler 1	703	New Gtr 31	739	UprightPiano
652	HipHop Drms1	704	PnoRvb 14	740	SitarCmpRvb
654	HipHop Drms2	705	Small Hall11	741	AC Bass 3
655	TOP Drum Reverb1	706	PnoRvb21	742	VoxKB3
656	HOP Drum Reverb1	707	Empty Stage 11	743	Blackfriday
657	HopKickcmp1	708	Mutron 2	744	Blackestfriday
658	NoQuarter	709	Double Leslie 12	745	Flange 4
659	TechnoHHDly 1/8	710	Double Leslie 5	746	DoubldistLsle20
660	HOP Drum Reverb3	711	PlainComp12	747	Double Leslie15
661	HopKickcmp7	712	Double Leslie 11	750	Good Leslie1
662	Roomverb1	713	CDR Synth	754	Good Leslie4
663	Kickcmp6	714	SynthFlangenDely	756	GoodLeslie 6
664	Snarcmp11	715	QuantzEnhanceSyn	757	WhitrShadeLeslie
665	Reverb3	716	BladerunnrRvb	758	Inagadadavita
666	Small Dark Room	717	Deep FuzzBass 1	759	GoodLordLeslie
667	Snarcmp12	718	Eber Bass	760	Small HallComp1
668	Kickcmp13	719	SynFatener& Ech2	762	GoodLeslie 5
670	BeastieDrums	720	CP80Enhanc1	764	ShortPnoRvb31
671	Clunker13	721	Fisher'sHarm Mic	765	St CHDly
675	Funksnare9	722	AbbeyPianoHall2	766	Synphase1
676	Funksnare8	723	Medium Hall 2	768	St CHDly
680	EPDistPhase1	724	Fagen Phaser	771	Walrus EP
681	RayEP 1	725	Double Leslie 10	772	EPChr16
682	Deep Fuzz 1	726	SmallWurly	773	Siberia
685	Deep Fuzz 31	727	Basic WurlyEP	775	Deep Fuzz 5
687	ReverseVerb1	728	Double Leslie 13	780	Flange Echo 2
690	Acidflute	729	Cheese Horns	781	ARPMosque Room

## Effects

---

ID	EFFECT	ID	EFFECT	ID	EFFECT
782	Chr & Echo	823	ChrsDly4	861	Little Mu
784	Mutron Clav 2	824	Leslie Basic	862	SmallHornChamber
785	Siberia II	825	MoogBASSComp5	863	OmniStageDW
786	EnhanceComp1	827	EPChr1 Dyno	864	Clunker50
787	Shaper->Reverb2	828	Synphase17	865	PnoEQCmp3
788	Clav Phase1	829	Leslie Comp 1	866	Comp4
790	SynlaserFlange 1	830	PhaseDly104	867	3DogEP 1
792	RockyRaccoon	831	GoodLeslie 52	868	CompDelay
793	Squire	832	CPChrRvb1	869	PnoEnhanc22
794	Flange 4	833	DistLeslie Basic	870	cheap Chamber
795	Deep Fuzz Clav	834	CompKit111	871	EPChr11
797	Clav Comp1	835	CarlosSyn	872	Old Chamber
798	SmallClav	836	MaroonSynbass	873	ChefAid 1
799	Synth Shimmer	838	FloydEP1	874	Zep Fuzz 1
801	PhaseDly1	839	PnoCmpSndBoard 1	875	Bernie Clav
802	Shredlead1	840	SuperTrmpPhase	876	ClavRotoAmp
803	ThinphaseSweep	841	Wurly 1	877	Dark Niceverb
804	EnvComp41	842	ShortPlate4EPs	878	Basic RayEP 3
805	MoogBASSComp11	843	ShortPlate4EPs2	879	LatinHornCmp
806	SynFatener& Ech4	844	Aux Dark Room 2	880	Basic RayEP 2
807	Shredlead15	845	Elton1	881	Raffas DX7
808	PlainComp21	846	Aux Chamber	882	EPChr6
809	Garth	847	BowiePno1	883	PnoEnhanc3
810	BassFleaCompMu	848	BluesPnoCmpRvb 1	884	SynEnhancement
811	Chr & Echo 2	849	New Gtr 31	885	CompKik11
812	BasicCDR2	850	Soundboard 3	886	VintChamber
813	ShaperFuzzLead 2	851	OmniStage	887	SmallWurly2
814	AM Big Band	852	Double Leslie	888	Deep FuzzPnt 1
815	Clunker20	853	MedPlateJazFlute	889	Comp70
816	PadFX3	854	MistyMntn EP 2	890	FooldAgainVox
817	SynFatener& Ech5	855	PnoEnhanc22	891	CompKik111
818	MarleyClav1	856	ClavPhase1	892	Vintage Horns 3
819	Flange Echo 4	857	MedRoom10	893	Leslie Gospl
820	Deep Fuzz Clav 3	858	EPChr11	894	EPChr60
821	GetBack1	859	HardRhds1	895	Syn Lead A
822	Deep Fuzz Clav 5	860	PnoEnhancement	896	Deep Fuzz 51

ID	EFFECT	ID	EFFECT	ID	EFFECT
897	4-Tap Delay BPM2	933	Cheese Horns2	969	Blackfriday2
898	Shredlead3	934	SynthCDR20	970	CompDelay101
899	Synphase1	935	Vintage Horns 2	971	Sax Chamber 2
900	Synphase2	936	Chorus Pan Delay	972	Clunker501
901	SynthTrem2	937	Snarcmp101	973	Horn Plate 1
902	DWAuxRvb1	938	Filter1	974	Vintage Horns
903	Small Dark Room2	939	Syncpulsedw	975	BrightFlange2
904	Sax Chamber2	940	Kickcmp501	976	ThinphaseSweep2
905	Small Hall2	941	Snarshaper601	977	Small Comp102
906	Medium Hall2	942	ProBassComp3	978	EPPHase1
907	Real Niceverb	943	SynEnv5	979	NonKB3LesliePdl2
908	Opera House2	944	SnareComp101	980	FlangeComp3
909	Mosque Room2	945	BostonLeslie2	981	Mutron Clav 201
910	Bright Hall	946	Kickcmp104	982	SynChorusDly202
911	Echplex 1	947	Leslie MShoals	983	RayEP 1
912	AbbeyPianoHall	948	Snarcmp121	984	EnhanceComp121
913	Recital Hall 2	949	WhitrShadeLesli3	985	Clunker IIa
914	Echplex 2	950	Snarcmp112	986	Pad Depth Pt1
915	Medm Warm Plate2	951	Snarcmp113	987	AuxChorusHall
916	EQVelMorph	952	EnvKickcmp1	988	TechnoSyn1
917	Aux Echplex	953	Kickcmp602	989	Synphase102
918	Farfisa1	954	Snarcmp112	990	CompDelay
919	Good Leslie33	955	HipHop Drms101	991	CompMeltrn
920	Zep Leslie	956	PnoCmpSndBoard10	992	ARP
921	Snarcmp801	957	Epicsnare1	993	Triplet delay
922	kickcmp401	958	JumpSynth	994	Bigverb
923	Deep Fuzz 6	959	Funksnare88	995	Syncpulse
924	SynEnv4	960	Kickcmp441	996	compbass 2
925	SmallComp9	961	Upright3	997	CompDelay3
926	KickComp201	962	HopKickcmp701	998	Comp501
927	GoodLeslie 9	963	Leslie Comp 2	999	RMIPHase1
928	Falgor Gtr	964	Kickcmp301	1000	Joey Leslie 122
929	KickComp701	965	PnoRvb 1	1001	SynChorusDlydw2
930	Good Leslie34	966	PnoRvb2	1003	ECello2
931	Syncb1ip	967	HipHop Drms201	1004	violin2
932	CompDelay3	968	Breakdrums1	1005	Small StringRoom

## Effects

---

ID	EFFECT	ID	EFFECT	ID	EFFECT
1006	Viola2	1045	Heartbreaker	1125	7ft Solo
1007	Cello2	1046	S DW AlbumEQ1	1126	D TMP flat EQ
1008	FalgorwahGtr	1047	DynoChor73	1127	7ft Squashed
1009	Accdn Booth	1048	73DWPPhase2	1128	7ft Warm Jazz
1010	BRASS EQ/Comp	1049	Double Grand3	1129	9ft Classic
1011	SynTrem	1050	Dampers Up Forte	1130	Rhodes Multi as1
1012	InfinSynCathedr	1051	ChorVerb for Pad	1131	77ClikFix02
1013	Delay + Plate1	1052	dyn77Template	1132	7ft Smooth
1014	SEM TRldw	1053	SynChor&Dly1	1133	9ft w Strings
1015	SynthLeaddw	1054	Dampers Up Forte	1134	German Grand
1016	SynPadDW	1055	German Grand4	1135	Concert Grand
1017	AGT EnhCDdw	1100	Small Hall	1136	Warm Grand 1
1018	'CasterTremdw	1101	steincoNcert2	1137	D Template 3
1019	LesTremdw	1102	steincoNcert3	1138	Rich 7 ft Grand
1020	StdioCasterRigdw	1103	warm stein1	1139	7ft Vintage Rock
1021	PercVerb1	1104	9ft ppp	1140	Darker D
1025	Rhodes FX 1	1105	Studio Piano as	1141	Oscar's Grand eq
1026	Small Hall	1106	dancestudioyam1	1142	7ft Squashed2
1027	Tweet piano	1107	Slo Attack Hall	1143	Clear 9ft Grand
1028	Y Grand EQ 2	1108	7-Ft Piano asFN	1144	2.0ms Hall
1029	Soundboard 3	1109	big stein 1	1145	Warm 7ft Grand
1030	9-Ft Piano FX2	1110	77ClikFix01	1146	.78ms Hall
1031	77DWWintAmp2hi	1111	crtalsdelay 1	1147	House 7ft Grand
1032	Tremolo BPM	1112	brtpunch yam	1148	New Age Grand
1033	Pianarama! verb	1113	7ft RockVerb1	1149	Rhodes MultiFX 1
1034	Solaris	1114	7Ft Vintage Rock	1150	Rhodes Aux Verb1
1035	SolarisGateLazer	1115	Vintage Class C	1151	Rhodes MultiFX 2
1036	Existential Taps	1116	Dance Studio	1152	Rhodes Aux Verb2
1037	URage_CmpRvb	1117	DanceStudioVerb	1153	1.6ms Hall
1038	77DWDYNOAmp1	1118	OldSquashed D	1154	1.6ms Plate
1039	LintBuster LD	1119	New Age Stn 1	1155	9ft Solo Grand
1040	RSessionGTR	1120	big warm stein	1156	9ft DarkDistant
1041	77DWDYNOAmp2	1121	big warm C	1157	7ft C
1042	77DWDYNOAmp3	1122	Darker D	1158	9ft Bright Grand
1043	Y DW Rock EQ	1123	Dampers Up Forte	1159	7ft Bright Grand
1044	Y DW Rock EQ2	1124	damperverb 2unit	1160	Harpsichord 1

ID	EFFECT	ID	EFFECT	ID	EFFECT
1161	Harpsichord 2	1211	Soft Rhodes	1417	NAMMClavFuzz1
1162	Vintage Squashed	1212	Soft Rhodes2	1418	ClavNAMMPhasDst1
1163	House 9ft Grand	1213	SoftStTrem Rhds	1419	ClavNAMMPhasDst2
1164	Super Pop eq	1214	73SparkleTop	1420	73DWPHASE2
1165	Scoop 9ft Grand	1230	Supa Clav	1421	77DWChor2
1166	Brt Scoop 9ft	1231	Heartbreaker	1422	73DWPHASDist1
1167	Brt Scoop 7ft	1232	Relic Clav	1423	73DWPHASDist2
1168	ARTISCncertPnAS1	1233	Steely Fuzz	1424	73DWPHASDistWah
1169	9ft Solo Grand2	1234	Stevie Fuzz	1425	77DWPHASDstWah1
1170	Dampers Upright	1235	Trampler	1426	73DWPHASDistWah2
1171	German Grand2	1236	Trampler2	1427	73DWVintamp2
1172	Double Grand1	1237	OutaPhasePickups	1428	77DWVintAmpWah
1173	Piano + Pad	1238	Chaka Wah	1429	DampersUp
1174	9ft w Strings2	1239	ChameleonWah	1430	Sweet PnoHall
1175	FM n K EQ2	1240	Beck Wurly	1431	77 cdr g1 t
1176	Artis Pluck EQ2	1241	BlkCrows Wurly	1432	Sweet PnoHall 2
1177	German Grand3	1242	Clav Chamber	1440	DeepfuzWurly1
1178	Double Grand3	1300	Weapon Chain	1500	Rds AuxVerb Long
1179	German Grand4	1301	Double Chorus	1501	Comp Piano FX
1180	damperverb 4unit	1400	73DWPHASE1	1502	Piano MultiFX 1
1181	Mono Upright	1401	77NAMMChor1	1503	Dist Clav FX
1182	CMartPiano 1	1402	77NAMMChor2	1504	Dist Clav CB FX
1183	Dampers Up 2.5ms	1403	73NAMMPHASDist1	1505	Synth HF Stim
1184	Brt Upright7ft	1404	77DWDstTrem1Wah	1506	Synth HF Stim 2
1185	Concert GrandEQ7	1405	73DWStTrem1	1507	SuperSaw Aux
1200	JSP Comp & EQ	1406	73NAMMStTremDst1	1508	SuperSaw
1201	Album Plate	1407	73NAMMStTremDst2	1509	Chroma FM3
1202	DW 70s AlbumEQ1	1408	77NAMMVintAmp1	1510	KB3 Aux2 Booth
1203	Y DW Elton EQ2	1409	DWWurlyVintAmp1	1511	GANGsta Wrap 2
1204	DW70sAlbumEQSoft	1410	WurlyRayAmp1	1512	KB3 Aux2 Booth 2
1205	Ghost EQ Soft	1411	NAMMSuperTrmpPha	1513	Organ Chamber2
1206	DarkUpright EQ	1412	DWWurlyPhasDst1	1514	NonKB3 A KX 2
1207	BriteUpright EQ	1413	DWWurlyBriteAmp1	1520	String Multi FX1
1208	Upright Room	1414	NAMMWryDeepFuzz	1521	SymphonyHall Aux
1209	70s Blues 7ft	1415	NAMMWryDeepFuz2	1522	MltiFX for Stngs
1210	Tramp Amp	1416	NAMMClavTrampler	1530	Rhodes-Chorus

## Effects

---

ID	EFFECT	ID	EFFECT	ID	EFFECT
1531	Rhodes-Flange	1657	Ambient Pno EQ	1701	FunkyPerc Les 01
1532	Rhodes-Phaser	1658	Blown Spkr Ins	1702	SoulPerc Les 01
1533	Rhodes-Rotary	1659	Recital Piano3	1703	PerfectStrLes01
1534	Rhodes-Env Filt	1660	FM n K EQ	1704	70s Drwbars Les1
1550	Rhodes1 Aux	1661	FM Hall	1705	Prog Bars Les01
1551	Rhodes Aux Room1	1662	ConcertK lite1	1706	FirstThree Les03
1552	DampersUp	1663	ConcertK lite2	1707	Ezra II Les 01
1553	Tines FX	1664	Soundboard as	1708	kb3 cab1
1554	9-Ft Piano FX	1665	ConcertK 4sc	1709	FunkyPerc Les 01
1555	DampersUp	1666	damper verb	1710	SoulPerc Les 01
1556	Sweet PnoHall	1667	ConcertK EQonly	1711	FunkyPerc Les X
1557	Sweet PnoHall 2	1668	Artis Y Grand2a	1712	70s Drwbars Les1
1558	Tines FX	1669	Artis YHall 2	1713	Prog Bars Les01
1559	9-Ft Piano FX	1670	Upright Room	1714	FirstThree Les03
1606	Artis KHall	1671	ParlorPianoEQ	1715	Ezra II Les 01
1610	Artis LrgKHall	1672	ParlorVerb	1716	SoulPerc Les X
1611	Upright EQ	1673	PianoTmplateEQ1	1717	FirstThree LesX
1612	Artis LrgKHall	1674	ModJazz K2	1718	PerfectStrLes X
1613	ConcertGrand1	1675	Brgt Soundboard	1719	70s Drwbars LesX
1617	ModJazz Plate 1	1676	Recital EQ	1720	Prog Bars Les X
1619	Punch Room	1677	Radio Pop EQ	1721	Ezra II Les X
1627	Concert Grand EQ	1680	Concert GrandEQ4	1722	CrunchLesl122 X
1628	Y Grand EQ 2	1681	Soundboard 4	1723	SoulLeslie122 X
1630	Bright Y EQ2	1682	ModJazz K3	1724	Jimmy'sBrakeX
1632	Artis K Pop EQ	1683	Upright EQ2	1725	DistlLes HotGsX
1633	Dark n Distant	1684	Pianarma EQ+Cm4	1726	NonKB3 A KX
1634	Artis Pluck EQ1	1685	JSP Comp & EQ2	1727	Leslie 122 K X
1635	Artis Y EQ	1686	Recital Piano 3	1728	LightDistlLes KX
1640	Bebop Piano	1687	ArtEQCMPas2	1729	Clean Leslie KX
1643	ModJazz K1	1688	Weapon Chain2	1800	Wurly Template
1648	Piano + Pad	1689	MarquisPiano3	1801	Clav Template
1649	Delay Piano	1692	ClassicBLesFstv4	1802	Rhodes Aux Huge
1650	Mono EQ	1693	Concert GrandEQ6	1803	7ft Aux Verb1
1651	RecitalHall	1694	ClassicBLesFstv4	1804	9-Ft Piano FX
1655	BigChorusPiano2	1696	ClassicBLesFstvX	1805	Yam ppp
1656	Lrg Ambience I	1700	kb3 cab1	1806	CDR Aux Reverb

ID	EFFECT	ID	EFFECT	ID	EFFECT
1807	Dark Wobbles	2053	Pad Depth Forte	3207	Tenor Sax
1808	Tines Aux Rev	2054	ChorVerb for Pad	3208	GANGsta Wrap
1809	Synth Dist CDly	2055	Symphony Harpsi	3209	Basic Delay 3/16
1810	Mosque w/Inf Rev	2101	ChoDistDly2	3210	DbISloFlangeCmp
1811	MosqueySwirl Aux	2102	Dark Room 2	3211	Pan Trem BPM
1812	Forte Lead Insrt	2103	Carrot Rev	3212	Pan Trem BPM OOP
1813	Comp Lead Insert	2104	Carrot 1a	3213	BPM Pad ChDeRv
1814	CDR Just Reverb	2108	Cab-Reverb	3214	supersaw 2
1815	Wah Synth Insert	2110	PithrFIngDistDly	3215	Slow Phase
1816	Forte Lead GTR	2150	MarquisPiano3	3216	BPM Trance
1817	Phase+CH+Delay	2200	BluesPnoCmpRvb 1	3217	Lazer DUB
1818	Dist/Wah Insert	2201	BluesPnoCmpRvb 2	3218	Krafty Monks
1819	Comp Plex Insert	2202	BluesPnoCmpRvb 3	3219	dist Booth
1820	Comp Mu Aliasr	2203	ArtEQDW1	3220	Delay + Plate
1821	Elegant Hall Aux	2204	ArtEQCMPDW5	3221	Dist Booth Dly
1822	FlangVoXHall2Aux	2205	ArtEQCMPDW6	3222	Sonny More I )
1823	FlangVoiceInsert	2206	ChessRecords1	3223	JSP Synth CDL
1824	Cathedral Vx Aux	2207	ArtEQCMPDW7	3224	Synker1
1921	MarquisPiano3	2208	MarquisPiano1	3225	SynCompMu1
2000	GM Reverb	2209	MarquisPiano2	3226	Shred Gtr
2001	GM Chorus	2210	Rachverb	3227	Shred Gtr Wah
2002	Indie Piano	2211	MarquisPiano5	3228	Chunky G 1
2003	BluesPnoCmpRvb 2	2212	ChessRecords2	3229	AuxGtrEchplex
2004	ArtEQ3	2300	JK FX Template	3230	Synth Delay 1/4
2005	ArtEQDW4	2303	jk AUX1	3231	Bari Sax
2006	ArtEQDW5	2500	Pianarma EQ+Cmp	3232	Electric Mermaid
2007	ArtEQDW7	2501	Pianarama! verb	3233	Solo Trumpet
2008	ArtEQDW8	2502	KikComp 4:1	3234	FLIP'n Chorus!
2009	ArtOddHarm	2560	MarimbDelay BPM	3235	FLIP'n Delay!
2010	SoftPnoCmpRvb 1	3200	SEM TRI	3236	RedHot Dst/Cho
2011	SterPnoCmpRvb 2	3201	RAVE WIND	3237	RedHot Reverb
2012	SoftPnoCmpRvb 2	3202	Chroma FM	3238	RedHot Delay
2013	SterPnoCmpRvb 3	3203	Chroma FM2	3239	Miami Gated Room
2050	Concert Piano FX	3204	Iceman Bass	3240	Miami Plate Rvb
2051	Studio Piano FX	3205	Mandocaster	3241	SnarkyDimplix Rb
2052	Dampers Up Forte	3206	Daft Lead	3242	FLIP'n Distortn!

## Effects

---

ID	EFFECT	ID	EFFECT	ID	EFFECT
3243	Synth Brass Env	3279	Synth Bass CDR	3315	Syn Brass Plate
3244	Van BrownSound	3280	BOC Deverb	3316	Syn Str Hall
3245	Van Reverb	3281	Gtr Niceverb	3317	E-Bow 1
3246	Gated Plate	3282	TripleCaster1	3318	THX
3247	Van EQ	3283	TripleCaster2	3319	WorldCDR1
3248	WarmCruncher2	3284	TripleCaster3	3320	WarmCDR
3249	Scorb4Tap/Rv BPM	3285	TripleCaster4	3321	Chunky G 1
3250	Scorb-olo BPM	3286	TripleCaster5	3322	OBI 1
3251	Here Lil' Boy!	3287	TripleCaster6	3323	SYnBassCompMu
3252	DiPulsulator	3288	TripleCasterWah	3324	MarimbDelay BPM
3253	PadmePlecks BPM	3289	TripleCasterEQ	3325	DW GatedLaserver
3254	ToodleTrem	3290	TripleCaster31	3326	Chillwave Chords
3255	ToodleDelay 1/8	3291	TrumpetWah	3327	Burning Keys 3
3256	Zap Chamber	3292	E-Bow	3328	EnhanceSyn
3257	'CasterTrem	3293	1/2-1/4DlyBPM	3329	Burning Keys 6
3258	LesTrem	3294	Phase	3330	StTaps1
3259	AS Laser Reverb	3295	EQVelMorph L	3331	Flange Mayhem2
3260	as Laser Reverb	3296	EQVelMorph R	3332	Mute Gtr1
3261	NuBeautyDist	3297	HF Stim	3333	SynthCDR
3262	AmbientPanner	3298	InstantHillbilly	3334	3str Gtr Wah2
3263	NuBeautyDist2	3299	HoRnYFIAnGePaRtY	3335	WorldMandolinCDR
3264	HammerDulceComp	3300	BRASS EQ/Comp	3336	Padme's lil' Pal
3265	Dulcimer Chorus	3301	MouthyFilter	3337	Squeeze Cmp
3266	HammerDulceRoom3	3302	Super8 Horn Dly	3338	Klockwork
3267	HammerDulceComp2	3303	BrassMod+AMRadio	3339	Bass Fishing
3268	LesChorus	3304	7thHeaven Plate	3340	Wave Rider
3269	EGT Multi 1	3305	7thHeavenCmpSlap	3341	TripleCaster6
3270	Kinda Krunchy2	3306	Bullitt PDlyHall	3342	TripleCasterWah
3271	Pan Trem BPM OOP	3307	Bunny Delay 3	3343	Mr.West Horns
3272	SEM Shape	3308	Van Brown LITE	3344	TripleCaster31
3273	Bright Syn Pad	3309	Van ChDly LITE	3345	SynPnoPhase1
3274	Synth Delay/RVB	3310	Sax-susolo Plate	3346	PBS on VHS
3275	Syn Chor DDL	3311	THX	3347	Attack Trance
3276	Syn Dist/Delay	3312	StdioCasterFXRig	3348	HPF Drum Taps
3277	huge space 2	3313	BonzoCompLTE	3349	Lectro Plate
3278	SynPad	3314	BonzoLTE GateRvb	3350	Nasty Syn Brass

ID	EFFECT	ID	EFFECT	ID	EFFECT
3351	Syn Str Hall	3472	SnrEnhanceComp	4015	R&B Stack
3352	BOC Deverb	3473	NewKickComp 1	4016	Super Pop
3353	Popcorn Plate	3474	CmpVerb4Drms2	4017	70s Album
3354	Plantasia Plate	3475	DistCompRev4Drms	4018	Artis Grand
3355	New Horns 1	3476	DrmCMP4PrgNew	4019	Legacy Grand
3356	Phase DW	3477	Ricochet Verb	4020	New Age Grand
3357	SynChor&Dly1	3478	VerbW/Stereo 2	4021	Piano & Harp
3358	Mando EQ	3479	DubDelayer	4022	Piano & Choir
3359	WorldMandolnCDR1	3480	DarkDrumSlap Sys	4023	Mood Ring
3360	Dist Booth Dly	3481	ExpStereoDrmHall	4024	Ambience
3361	Synth Bass CDR	3482	Snr Enhnce HiCut	4025	Film Piano
3362	Infin Cathedral	3483	Trans DrmComp	4026	Soul Piano
3363	Forte Pad Insert	3484	CmEqDeRe4DrmSTb	4027	Pub Piano
3364	Punch-a-ghost	3485	CmpDistRev4Drms	4028	Double Grand
3365	ElecMandolin	3486	VinylDistImage	4029	Mono Upright
3366	Gallo Dist+ EQ	3487	Dub hall	4030	Double Squash
3367	UnderCurrnts	3489	JK GatedLaserver	4031	Vintage Squash
3368	UnderCurAux	3490	JK Marimba Hall	4032	House Piano
3369	DW Laser Reverb	3491	JK Green Room	4033	Rooftop 73 Rhds
3370	Cathedral ChorDW	3492	JK Laser Reverb	4034	Steely Dyno 77
3456	BreakdrumsNEWKIK	3493	Dubstep Drumz	4035	Vintage Amp Wrly
3457	Lil' Drum Booth	3494	DubDelayer	4036	Amped Bell 73
3458	Small Drum Space	4001	Rich 9 Ft Grand	4037	BarkDist 77 Rhds
3459	Small Cmpsd Spce	4002	Rich 7 Ft Grand	4038	Becks Retro Wrly
3460	More Drum Air	4003	Rock 9 Ft Grand	4039	Phasey 73 Rhds
3461	Full Drum Room	4004	Bright 7ft Grand	4040	Mr. SparkleTop73
3462	Brite Drum Space	4005	Solo 9 Ft Grand	4041	Aged Tolex 77
3463	Garage Drums	4006	Solo 7 Ft Grand	4042	Smooth 70's 73
3464	Expandn'DrumHall	4007	Vintage Upright	4043	FusionChorDyno73
3465	Expandn'Drum 481	4008	Vintage Grand	4044	Chorus 77 Rhds
3466	Expandn'DrumPLTE	4009	Elegant Grand	4045	73/77 StereoBels
3467	Expandn'Drum GYM	4010	New Orleans	4046	Env Filt Rhds
3468	SnappyDrumCmpVrb	4011	Dark & Distant	4047	Ray's Wurly
3469	Drum Enhancer	4012	Piano + Pad	4048	Deep Fuzz Wurly
3470	DrumComp subtle	4013	Piano & Strings	4049	T-Bone Wurly
3471	Snare Enhancer	4014	Punchy Edge	4050	Phase Dist Wurly

## Effects

---

ID	EFFECT	ID	EFFECT	ID	EFFECT
4051	Bright Fuzz Wrly	4093	PerfectStrLes X	4129	Dark Wobbles
4052	Tramp Amp Wurly	4094	70s Drwbars LesX	4130	Daft Lead
4053	FM EP 1	4095	Prog Bars Les X	4131	Minipulse 4Pole
4054	FM EP 2	4096	Ezra II Les X	4132	Frankenstein Wah
4055	Rhotary Rhds 73	4097	CrunchLesl122 X	4133	Candy*O Sync
4056	Elec Grand Stack	4098	SoulLeslie122 X	4134	Raw & Bleedin
4057	BrightRMI Pn/Hrp	4099	Jimmy'sBrakeX	4135	Dist Filter Lead
4058	Tight Bright FM	4100	DistlLes HotGsX	4137	Film Score Pad
4059	Gabriel's Melt	4101	NonKB3 A KX 2	4138	Majestic Pad
4060	CP80 Enhanced	4102	VoxKB3	4139	So Lush Pad
4061	VideoKilledRadio	4103	VoxKB3	4140	Bladerunner ARP
4062	UK Pop CP70	4104	Farfisa1	4141	CrotaleScape Pad
4063	MistyMountain EP	4105	All Stops	4142	UnderCurrents
4064	No Quarter Pnt	4106	AllStopsAllVox	4143	Fairlight Pad
4065	Black Friday	4107	Pipe Stops	4144	Phase Shimmer
4066	Sly Ballad	4108	Chapel Organ	4145	Evolving Pad
4067	RoyalKingWakeman	4109	Pipes & Voices	4146	Lush Pad
4068	StageTines Soft	4110	16' Open Flute	4147	Deeper Water
4069	Suitcase Tines	4111	16' Ped Reed	4148	Lush Rhythm Pad
4073	Chaka Clav	4112	16' Reed A	4149	Cosmic Sus Pedal
4074	SupaStevie CB	4113	16' Viol	4150	Solo Syn Orch
4075	Funkadelic Relic	4114	Leslie 122 K X	4151	Add A Pad 1
4076	ZEP Clav	4115	LightDistlLes KX	4152	Add A Pad 2
4077	HeartbreakerWAH	4116	Clean Leslie KX	4153	Super Saw
4078	Chameleon Wah	4117	Fisher'sHarm Mic	4154	Bright Vector
4079	Stevie Fuzz Amp	4118	SmallComp9	4155	Classic SynBrass
4080	OutOfPhasPickups	4119	Accdn Booth	4156	MW S&H Filt
4081	Fr Harpsi L84U8	4120	Accdn Booth	4157	80's Heaven
4082	Fr Harpsi L48	4121	Press Lead	4158	PolySynth Stack
4083	Fr Harpsi Lute	4122	Cars Square Lead	4159	Chillwave Chords
4084	Fr Harpsi L8	4123	Keytar Hero(Wah)	4160	Classic Saws
4085	Fr Harpsi U8	4124	Voyage Lead	4161	Big Old Jupiter
4089	ClassicBLesFstvX	4125	SimpleHipHopLead	4162	Punchy Synth
4090	FunkyPerc Les X	4126	SquareChirpLead	4163	Touch Trance
4091	SoulPerc Les X	4127	Vector Lead	4164	Square Bell
4092	FirstThree LesX	4128	80s Lead Synth	4165	Perc Vector

ID	EFFECT	ID	EFFECT	ID	EFFECT
4166	Tesla Coil	4202	Low Orch Brass	4249	Beasties Bass
4167	Warbly Pong SQR	4203	Lead Trumpet	4250	Levin/GabrlfrtlS
4168	Gangsta Wrap	4204	Solo Trombone	4258	Motown Bass
4169	Woodhouse Bass	4205	Jubilee Trumpets	4259	Finger Bass
4170	Aggro OctoBass	4206	Wah Trumpet	4260	Flea/Bootsy
4171	KneeDeepMiniMoog	4207	Mr. West Horns	4267	Celeste
4172	Squeeze Mini	4208	Bullit Brass	4268	Octave Celeste
4173	Iceman Bass	4209	Dr. StAb'N SwEll	4269	Bells
4174	ANGRY Bass	4211	Mostly Saxes	4270	Carillon
4175	Big Synth Bass	4212	UniSaxSection	4271	Basic Orch Perc
4176	Noise Bass	4213	Bassoon/Oboe	4272	Orch Timpani
4177	The Way It Is	4214	Solo Alto Sax	4273	Natural Perc
4178	Dolby Bass	4215	Solo Tenor Sax	4274	Percussionist
4179	Adagio Strings	4216	Flute/Clarinet	4275	Bongo Conga
4180	Big LA Strings	4217	Solo Bari Sax	4276	Talking Drum
4181	Fast Strings	4218	StrawberryFlutes	4277	Accessory
4182	Slow String Trem	4227	Rich 'Caster	4278	Carnival Perc
4183	AdagioTutti 8ves	4228	Rich Les	4279	Vocal Percussion
4184	Adagio Octaves	4229	SuperStudioCast	4280	Rogers Celeste
4185	NashvilleStrings	4230	PhasePickles	4283	Mixed Choir
4186	Poltergeist Pad	4231	TimeWarpCaster	4284	Manhattan Voices
4187	Full Pizzicato	4232	Kinda Krunchy	4285	Choir Complete
4188	Lead Violins II	4233	Brown Sound LTE	4286	NYC in LA
4189	AggressDivisiStr	4234	RedHot/StudioStr	4287	Crystal Voices
4190	Yesisis Tron Str	4235	SuperFlyWahCast	4288	Cathedral Vox
4191	Moby TurntblTron	4236	Jack the Ripper	4289	Silent Sorrow
4192	Solo Cello Fast	4237	Boutique Six Str	4290	Swept Tron Voice
4193	Solo Cello Fast	4238	Boutique 12 Str	4291	Slo Orch Chorus
4194	Solo Harp	4239	Real Nylon	4292	Aaah Vocals
4195	Session Hornz	4240	3Str Mandolin	4293	Jazzy Ballad Vox
4196	High-End Horns	4243	P-Bass	4294	Bright Syn Vox
4197	Split SectionSW	4244	Motown Bass	4295	AntiqueAhhChorus
4198	Mancini Brass	4245	Finger Bass	4296	Vox Angel
4199	GB Hornz+Syn	4246	Flea/Bootsy	4297	Aaahlicious
4200	Super-8 Brass	4247	Jaco Fretless	4298	PolyTechnobreath
4201	Brass Fanfare	4248	AC Buzzer Bass	4299	Glockenspiel

## Effects

---

ID	EFFECT	ID	EFFECT	ID	EFFECT
4300	Real Vibes	5016	Clav Chamber	5052	Miami Gated Room
4301	Stereo Marinba	5017	Green Room	5053	Miami Plate Rvb
4302	Xylophone	5018	AbbeyBrasHall2	5054	Tenor Sax
4303	XHarmonicStlDrum	5019	MedRoom10	5055	Bari Sax
4304	Chimes	5020	Medium Hall	5056	Small Dark Room2
4305	Bigger Chimes	5021	CDR Just Reverb	5057	Small Hall II
4306	Crotales Hits	5022	Real Niceverb	5058	Omni Stage
4307	Metal Marimba	5023	Small Hall	5059	DeepChorsDlyHall
4308	SteamPunkMallets	5024	Mosque w/Inf Rev	5060	AGT Reverb
4309	CeleseGlockHarp	5025	CDR Aux Reverb	5061	NylonAgtVerb
4316	Bellestrum VTrg	5026	Live RecitalHall	5062	Small Dark Room
4317	Toy Piano	5027	MosqueySwirl Aux	5063	HammerDulceRoom3
4318	Bunch of Bells	5028	BladerunnrRvb	5064	AbbeyPianoHall
4319	Synthy 73	5029	Dark Room 2	5065	Lil' Drum Booth
4320	Wurzzicato	5030	UnderCurAux	5066	Gated Plate 144m
4321	Comp Cro + Pad	5031	AbbeyPianoHall2	5067	SnappyDrumCmpVrb
4322	Clavestrum	5032	JK GatedLaserver	5068	More Drum Air
4323	Bowed Crotales	5033	SymphonyHall 1	5069	Full Drum Room
4324	Bells and Bows	5034	Gunshot Verb	5070	Expandn'DrumHall
4325	Bass Pedal	5035	SuperSaw Aux	5071	DrmCMPVb4PrgFX2
5000	Small Hall	5036	7ft Aux Verb1	5072	Aux Dark Room 2
5001	ShortPlate4EPs	5037	Cathedral Chorus	5073	CmpVerb4Drms2
5002	Sax Chamber	5038	SymphonyHall Aux	5074	Garage Drums
5003	Rhodes1 Aux	5039	Bradley's Barn 1	5075	SymphonyHall 3
5004	Real Nice Verb	5040	SymphonyHall 2	5076	Med Drum Room
5005	Opera House	5041	Empty Stage II	5077	PercussionRoom
5006	Rhodes Aux Room1	5042	AbbeyPianoHall 2	5078	PercVerb1
5007	Opera House2	5043	Sax Chamber 21	5079	Med Drum Room
5008	Medm Warm Plate2	5044	Smooth Long Hall	5080	Elegant Hall Aux
5009	Sax Chamber2	5045	Horn Plate 1	5081	FlangVoXHall2Aux
5010	Mosque Room2	5046	Super8 Horn Dly	5082	Cathedral Vx Aux
5011	ShortPlate4EPs2	5047	Solo Trumpet	5083	Classic Plate II
5012	Small Hall2	5048	Predelay Hall	5084	Real Niceverb II
5013	Medium Hall2	5049	Gtr Niceverb	5085	BigDarkRoomDW
5014	Tines Aux Rev	5050	Bullitt PDlyHall	5086	Empty Stage 11
5015	Little Booth	5051	7thHeaven Plate	5087	Cab-Reverb

<b>ID</b>	<b>EFFECT</b>
<b>5088</b>	jk AUX1
<b>5089</b>	Empty Stage
<b>5090</b>	DF OrganRoom
<b>5091</b>	KB3 Aux2 Booth
<b>5092</b>	KB3 Aux2 Booth 2
<b>5093</b>	Organ Chamber2
<b>5094</b>	KB3 Cab 1
<b>5095</b>	KB3 Cab 2
<b>5096</b>	Plebe Chamber
<b>5097</b>	1.6ms Hall
<b>5098</b>	Artis KHall
<b>5099</b>	2.0ms Hall
<b>5100</b>	Sweet PnoHall 2
<b>5101</b>	FM Hall
<b>5102</b>	.78ms Hall
<b>5103</b>	Album Plate
<b>5104</b>	OmniStage
<b>5105</b>	Artis LrgKHall
<b>5106</b>	Sweet PnoHall 2
<b>5107</b>	Lrg Ambience I
<b>5108</b>	Upright Room
<b>5109</b>	Upright Room
<b>5110</b>	.78ms Hall
<b>5111</b>	OmniStage 200
<b>5112</b>	Omni Stage Short
<b>5113</b>	Omni Stage 3

---

# Index

## A

Activating Zones 8-9, 8-12.  
Add Parameter 9-22.  
Aftertouch. *See* Mono Pressure.  
Alphanumeric Entry 9-13, 9-19.  
Alpha Wheel 3-12, 3-13, 6-2, 6-5, 6-6, 6-7, 7-2, 8-2, 8-3, 9-4, 10-2.  
Assign 9-4.  
    Enter + Controller 9-5.  
    Enter + Key 9-5.  
Audio 2-11.  
Audio Cables 2-2, 2-11.  
Audio In 3-10.  
Audio Input 10-5.  
Audio Jacks 2-11, 3-10.  
Audio Out S/M 10-5.  
Audio Problems 13-2.  
Auto Power Off 10-4, 10-5.  
Aux 1 7-8.  
AUX1 Override 9-28.  
Aux1 Parameter 9-28.  
Aux 2 7-8.  
AUX2 Override 9-28.  
Aux2 Parameter 9-28.  
Aux Effects 9-30.  
Aux FX Channel 9-28.  
Auxiliary Send Parameters 7-9.  
Aux Send Parameter 7-9.

## B

Balanced Cable 2-2, 2-11.  
Bank  
    Change 9-11, 9-12, 9-25, 10-14. *See* MIDI: Bank Changes.  
    MIDI 4-2, 9-11, 9-12, 9-25, 10-14.  
    Mode 9-11, 10-14.  
    Select 10-14.  
BankMode Parameter 9-11.  
B Audio Output 10-5.  
Bend 3-3, 9-25.  
Bend Down Ct 9-13.

Bend Down ST 9-13.  
BendRange Down Parameter 7-10.  
BendRange Up Parameter 7-10.  
Bend Up Ct 9-13.  
Bend Up ST 9-13.  
Brake D-2.  
Brightness 13-2.  
Brightness Knob 3-14.  
Bump 9-15, 9-22.  
Buttons  
    Alphanumeric. *See* Alphanumeric Entry.  
    Category 3-15, 6-2, 6-6, 6-7, 6-8.  
    Channel/Zone 3-13.  
    Double Press  
        Panic 6-20.  
        Program Demo 3-17, 5-7, 6-3.  
        Value Jump 3-13, 3-16, 6-6, 8-3, 9-6, 10-2.  
    Global 3-11.  
    Multi 3-11, 5-2, 8-1, 9-1.  
    Mute D-2.  
    Next 3-12, 3-13, 6-2, 6-5, 8-2, 8-3, 10-2.  
    Param/Channel 6-19.  
    Previous 3-12, 3-13, 6-2, 6-5, 6-7, 6-8, 8-2, 8-3, 10-2.  
    Program 3-11, 5-1, 6-1.  
    Soft 5-5, 5-7, 5-8.  
    Value 3-13, 6-5, 7-2, 8-3, 9-4.  
    Zone 3-5, 8-6.

## C

Category 3-15, 7-11.  
Category Buttons 6-2, 6-6, 8-4.  
Category Default. *See* Default (Category).  
CC Jack 1-3, 2-9, 3-5, 3-7.  
Chain 9-28.  
Change Multis Parameter 10-14.  
Channel 3-11, 3-13, 3-16, 4-1, 4-2, 5-2, 6-18, 6-19, 8-1, 8-6, 9-1, 9-11, 9-20, 9-24, 9-25, 10-15, 10-16, B-1.  
Channel Parameter 9-11.  
Channel / Zone Buttons. *See* Buttons: Channel/Zone.  
Chorus/Vibrato D-2.  
Clock Source 10-5.  
Common 9-18.  
Common Page 9-27, 9-29.  
COMMON Page 7-10.  
Common Parameters 9-1, 9-2.  
Common Problems 13-1.

---

## Index

---

Compatible Files 11-10.  
Compress 9-14, 9-22.  
Compressor 3-8.  
computer 12-7.  
Computer 2-13.  
Connecting Audio 2-2, 2-3, 2-10.  
Connecting MIDI 2-4.  
Connecting Pedals 2-7, 13-6.  
Continuous Controllers 9-20.  
Contrast Knob B-1.  
Control 7-5.  
Controller 1-2, 1-3, 2-4, 2-5, 2-6, 2-7, 2-9, 2-15, 3-4, 3-7,  
3-11, 3-12, 4-2, 5-1, 5-2, 6-11, 6-13, 6-16, 6-20, 6-21,  
8-1, 8-6, 8-8, 9-1, 9-4, 9-5, 9-11, 9-12, 9-19, 9-24,  
9-25, 10-13, 10-14, 10-15, 10-16.  
Controller Parameter 9-21.  
Controllers 6-12.  
Control Source 7-6.  
Controls Page 9-15.  
Crossfade 9-14, 9-22.  
Cursor Buttons 8-3.  
Curve Parameter 9-22.

## D

Default (Category) 6-6, 6-8.  
  Choosing 6-8, 8-5.  
Default (Power Up) 3-1.  
Delete 9-30.  
DELETE Page 10-20.  
Demo Song 2-3, 5-7, 6-3.  
Destination 9-9, 10-13.  
  Controller 9-24.  
  Local 9-9, 9-10, 9-12, 9-25.  
  MIDI 9-9, 9-10.  
Destination Parameter 9-9, 9-20, 9-24.  
Diagnostics 12-10, 13-7.  
Directories 11-2.  
Display 3-12, 6-4, 8-2, 9-3, 13-2.  
  Contrast Knob 3-14, B-1.  
Display Diag 12-16.  
Display Parameter 10-4.  
Double Button Presses 3-16, 6-6, 8-3, 9-6.  
Drawbars D-2.  
Drum Remap 10-10.  
Dual Switch Pedal 2-9.

## E

Edit Button 5-8, 9-1.  
Editing Parameters 3-16, 7-2, 9-1, 9-3, 9-4, 9-5, 10-1, 10-2.  
Effects 9-30, B-1, F-1.  
  Aux 9-30.

Enable Parameter 9-27.  
Entry Position Parameter 9-23.  
EntryPrgChg Parameter 9-13.  
Entry Program Change. *See* Program Change: Entry.  
Entry State 9-18, 9-19.  
Entry State Parameter 9-18.  
Entry Value 10-6.  
EQ. *See* Master EQ.  
Exit State 9-19.  
Exit State Parameter 9-19.  
Exit Value Parameter 9-23.  
Expand 9-14, 9-22.  
Expression 10-19.

## F

Factory 2-14, 4-2, 5-3, 6-4, 8-2, 8-15, 10-1, 10-21, 12-10,  
12-11, 12-12, 13-7, B-1.  
Factory State 4-2.  
Favorite Buttons 3-1, 6-2, 6-9, 8-2, 8-5.  
Favorites 2-15, 6-4, 6-9, 8-2, 8-5.  
Features 1-1, 3-1, 11-1.  
Feet (Rubber) 1-3, 2-1, D-2.  
File Name 11-4.  
Files 12-5, 12-12, 12-14, 12-16.  
  Delete All 12-11.  
  Load (Fill) 11-8.  
  Loading 9-12, 9-19, 12-2.  
  Saving. *See* Store.  
File Utilities 12-13.  
Firmware Update 2-18.  
Flash Drive. *See* USB Flash Drive.  
Foot Switches 3-6.  
Format System Flash Memory 12-14, 12-15.  
Front Panel 2-2, 2-14, 3-2, 3-4, 3-11, 3-12, B-1.  
Functions 5-5.  
  Demo. *See* Demo Function.  
  Layer. *See* Layer.  
  Program Demo. *See* Program Demo.  
  Split 5-5. *See* Split: Function.  
FX. *See* Effects.  
FX Mode Parameter 10-4.  
FX Page 7-7.

## G

Getting Started 2-1.  
Global Button 3-11.  
Global Mode 2-17, 3-1, 3-11, 3-12, 4-2, 5-2, 5-3, 10-1, 10-2,  
10-3, 10-12, 10-13, 10-21, 11-5, 11-7, 12-11.  
Global Parameters 5-3, 9-9, 10-1, 10-23.

## H

---

Half Damper Pedal. *See* Pedal: Half Damper.

Headphones 2-2, 2-4, 2-10, 2-11.

High Key 9-5.

HiVel Parameter 9-15.

## I

ID Numbers 5-7, 6-20, 6-21, 8-15, 8-16, 10-16.

Info 1-3, 2-15, 2-17, 2-18, 10-19.

Insert 7-8.

Install 12-4, 12-7.

Install Module 12-16.

Int. Key 10-10.

Intonation Key 10-10.

Intonation Map 10-9.

## J

Jump 3-16.

## K

K2600 Bank Mode 9-11.

KB3 3-4, 3-14, 4-1, D-1.

KB3 Channel 9-30.

KB3 Mode 1-2, D-1, D-2.

Controls 3-3, 3-4, 3-6, 3-7, 3-14, B-1, D-2 to D-4.

KB3 LED 3-14.

KB3 Programs D-1.

Key1 Parameter 9-19.

Keyboard 1-2, 2-1, 2-3, 3-5, 4-1, 4-2, 5-2, 5-5, 6-13, 8-6,  
8-9, 9-9, 10-15, 10-16, 10-19, B-1, D-1, D-2.

KeyClick D-3.

Key High. *See* High Key.

Key Low. *See* Low Key.

Keypad 3-15.

Keypad Button 6-7.

Keypad Buttons. *See* Buttons: Keypad.

Key Range Parameter 6-14, 6-17, 8-10, 8-13, 9-7.

Knob 3-7, 3-14.

KUF File 4-2, 12-3, 12-5, 12-8.

## L

Layer 2-17, 4-2, 6-18, 8-14.

Function 4-2, 5-5, 5-6, 6-16, 6-17, 8-12.

Program 8-12.

LCD Display 3-7, 3-12, 5-5, 10-3, B-1.

LED 3-5, 3-6, 3-7, 3-8, 3-11, 3-14, 6-1, 6-6, 6-8, 6-10, 6-11,  
6-21, 8-1, 8-6, 8-7, 10-1.

LED Ladder 9-23.

LED Ladders 3-5.

Linear 9-14, 9-22.

Load. *See also* Files: Loading.

PC 2-14, 12-7, 12-8, B-1.

USB 1-3, 2-4, 10-4, 10-12, 10-15, 11-5, 11-6, 11-7, 11-8,  
12-3, 12-4, 12-5, 12-7, B-1.

LOAD 11-2, 11-8.

LOAD Page 11-7.

LocalKbdChan 10-15.

Local Keyboard Channel 10-15, 10-16.

Local Program 9-12.

Low Key 9-5.

## M

MAIN1 Page 10-3.

MAIN2 Page 10-6.

Main Page 9-8.

Maintenance 12-1, 13-1.

Master EQ 3-1, 3-7, 3-8, B-1.

MIDI 1-2, 2-17, 6-4, 8-3, 10-17.

Bank. *See* Bank: MIDI.

Bank Change Messages 9-12, 9-25.

Channel 3-11, 3-16, 4-1, 4-2, 5-2, 6-1, 6-18, 6-19, B-1.  
*See also* Channel.

Channel Transmit 3-13, 6-19, 8-1, 8-6, 9-1, 9-11, 10-12,  
10-15.

Connecting. *See* Connecting MIDI.

Implementation Chart A-1.

Page 10-12.

Ports 2-4, 10-12.

Problems 13-5.

Program Change 9-12, 9-13.

Program Parameter 9-12, 9-13.

MidiBank Parameter 9-12.

MidiProg Parameter 9-12.

Mirror Primary Outputs 10-5.

Mode 2-3, 3-8, 3-11, 4-2, 5-1, 5-5.

Buttons 2-3, 3-10, 3-11, 5-1, 5-2, 5-3, 6-1, 8-1, 9-1, 10-1,  
D-2.

Global. *See* Global Mode.

Multi 3-4, 3-5, 3-7, 3-11, 4-1, 5-2, 5-5, 5-6, 5-8, 6-13,  
6-15, 6-16, 6-17, 6-18, 8-1 to 8-18, 9-24, 9-30, 10-13,  
10-16.

Multi Edit 3-7, 3-16, 5-8, 6-15, 6-17, 9-1, 9-2, 9-3, 9-4,  
9-5, 10-16.

Program 2-3, 3-4, 3-7, 3-11, 3-13, 3-16, 5-1, 5-5, 5-6, 5-7,  
6-1 to 6-24.

System. *See* System Mode.

Mode Buttons 3-11.

Mode Parameter 9-17, 9-22.

Mod Wheel 1-2, 3-3, 3-6, 4-1, 5-1, 6-10, 6-11, 8-7, 8-8,  
9-20, 9-24, 10-16.

Momentary 9-18.

mono 10-18.

Mono 2-2, 2-11.

## Index

---

Monopressure 1-3.  
Mono Pressure 4-2, 9-26, 10-8, B-1.  
Mono Switch Pedal. *See* SW1; *See* SW2.  
Multi Controllers 10-6.  
Multi Edit Mode 2-17, 3-7, 3-16, 5-8, 6-15, 6-17, 6-18, 8-9, 8-11, 8-12, 8-14, 9-1, 9-2, 9-3, 9-4, 9-5, 10-16.  
Multi Mode 2-17.  
Multis 2-14, 3-11, 4-1, 5-2, 8-1 to 8-18.  
    Deleting. *See* Deleting User Multis.  
    Editing. *See* Multi Edit Mode.  
    Favorites. *See also* Favorite Buttons.  
    Parameters List. *See* Zone: Parameters.  
    Saving 6-15, 6-18, 8-11, 8-15.  
    Zones. *See* Zone.  
Music Rack .  
Muting Zones 2-7, 8-6.

## N

Naming 6-21, 6-23, 8-17, 9-6.  
Navigation 3-2, 3-12.  
New Directory 11-4.  
Note Map Parameter 9-9.  
Numeric Entry. *See* Alphanumeric Entry.

## O

Objects 4-2.  
    Deleting All 12-11.  
    Loading. *See* Files: Loading.  
    Programs. *See* Program.  
OffValue 9-5.  
Off Value Parameter 9-18.  
OnValue 9-5.  
On Value Parameter 9-18.  
Organ 3-4.  
Out Pair B Mode 10-5.  
Out Parameter 9-11.  
Output Gain Parameter 7-11.  
Output Parameter 7-9.  
Overview Page 9-6.  
OVWRTE 11-8.

## P

Pan 9-24.  
Panic 3-18. *See also* Buttons: Double Press: Panic.  
Pan Parameter 6-15, 6-18, 8-10, 8-13, 9-7.  
Param/Channel Buttons. *See* Buttons: Param/Channel.  
Parameter 7-5.  
Parameter Assignments 6-11, 9-24.  
Parameters 10-2.  
PARAMS Page 7-4.  
Path 11-2.

PC 2-14, 12-7, 12-8, B-1.  
Pedal 1-2, 1-3, 2-7, 2-8, 2-9, 4-1, 5-1, 8-8, 13-6, B-1.  
Pedal Noise 10-10.  
Percussion D-3.  
Pitch Wheel 1-2, 3-3.  
Pop-Up Messages 6-5, 8-3.  
Power iv, v, 2-2 to 2-8, 3-1, 10-2, 10-4, 10-5, 12-1, 13-1, 13-2, 13-6, B-1.  
    Problems 13-1.  
Power Cable v, 1-3, 2-2.  
Power Off 10-4. *See* Auto Power Off.  
Pre/Post Ins Parameter 7-9.  
Pressure. *See* Mono Pressure.  
Pressure Map 10-8.  
PrgChangeMode Parameter 10-15.  
Problems 13-1.  
Program 2-14, 3-11, 4-1, 5-1, 6-1 to 6-24, 6-4, 7-4.  
    Demo 2-3.  
    Favorites. *See* Favorite Buttons.  
    List C-1, E-1, F-1.  
    Mode 10-13, 10-15. *See* Mode: Program.  
    Saving 6-21.  
    Selection 2-13, 2-14, 6-2, 6-6.  
Program Change. *See* MIDI: Program Change.  
    Entry 9-13.  
    Function. *See* Functions: MIDI Program Change.  
Program Change Mode 10-15.  
Program Demo. *See* Functions: Program Demo.  
Program Edit Mode 2-17, 5-8, 7-1.  
Program Mode 2-16, 4-1.  
Program Parameter 6-14, 6-17, 8-10, 8-13, 9-6.

## R

Real Time Control 3-4.  
Rear Panel Connections 1-3, 2-4, 2-11.  
Reset 2-18, 3-11, 4-2, 10-21.  
    System 12-11, 12-12, 13-7.  
Reset Transposition 3-17.  
Restore 12-16, 13-7. *See also* Reset.  
Restoring Factory Defaults 13-7.  
Rotary S/F Override D-4.  
Rubber Feet. *See* Feet (Rubber).  
Run Diagnostics 12-10.  
Run Forte 12-2.  
Rvrs Compress 9-15, 9-23.  
Rvrs Crossfade 9-15, 9-23.  
Rvrs Expand 9-15, 9-23.  
Rvrs Linear 9-15, 9-23.

## S

Save 2-16, 6-11, 6-18, 6-24, 8-11, 8-14, 8-18, 9-30.  
    *See* Multis: Saving; *See* Program: Saving; *See* Store.

---

Scale Parameter 9-22.  
 Select Directory Dialogue 11-3.  
 Selecting  
   Modes. *See* Mode: Buttons.  
   Objects. *See* Objects: Selecting.  
 Service Centers 13-7.  
 Sliders 1-2, 3-4, 3-5, 3-7, 4-1, 5-1, 6-11, 8-8, 9-20, 9-23,  
   9-24, 10-16, B-1, D-2.  
 Soft 1-3.  
 Soft Button. *See* Buttons: Soft.  
 Soft Pedal 9-25.  
 Soft Reset. *See also* Reset: Soft.  
 Software  
   Restore. *See* Restore.  
   Update. *See* System Update.  
 Song Demo 3-18, 5-6.  
 Sostenuto 1-3, 2-7, 9-25, 13-6.  
 Specifications B-1.  
 Split 2-17, 4-2, 6-15, 8-11.  
   Button 6-13, 8-9.  
   Function 4-2, 5-5, 6-13, 8-9.  
   Program 6-13, 8-9.  
 STATE 10-19.  
 Status Parameter 9-6.  
 Storage Mode 2-18, 5-4.  
 Store 10-21, 11-5, 11-6.  
 STORE 11-2.  
 STORE Page 11-5.  
 Support 12-10, 12-16, 13-7.  
 Sustain 1-2, 1-3, 2-7, 9-25, 13-6, D-4.  
 SW1 1-3, 2-7.  
 SW2 1-3, 2-7.  
 Switch 3-7, D-2, D-3.  
   Foot. *See* Foot Switch.  
 Switch Buttons 3-5, 4-1, 5-1, 6-11, 8-8.  
 Switch Controllers 9-16.  
 Switch Pedal 1-3, 2-7, 2-9, 13-6, B-1. *See also* Pedal.  
 Sysex ID 10-16.  
 System Mode 12-1, 12-2, 12-4, 12-7, 12-12, 12-13, 12-14,  
   13-7.  
 System Reset 2-18.  
 System Update 1-3, 2-4, 4-2, 12-3, 12-4, 12-6, 12-7, 12-9,  
   12-14, B-1.  
 System Utilities 12-13.

**T**

Tablet , 2-4, 2-13, 12-7, B-1.  
 Tap Tempo 1-2, 3-7.  
 Tempo Parameter 9-29.  
 Thumb Drive. *See* USB Flash Drive.  
 Toggled 9-18.  
 TOOLS Page 10-16.  
 Transpose 3-6, 6-10.

Buttons 3-6, 3-7, 6-10, 8-7, B-1.  
 Reset 3-6, 6-10, 8-7.  
 Zones 8-7.  
 Transpose Parameter 9-9, 10-3.  
 Transpose switches 1-2.  
 Transposition 3-17.  
 Troubleshooting 12-10, 13-1, 13-7.  
 Tune Parameter 10-3.  
 Tuning 3-6, 3-11, 6-10, 8-7.  
 Type Parameter 9-18.

## U

Update 2-4, 2-18.  
 USB Flash Drive 2-4, 11-5, 11-7, 12-3, 12-4, 12-5.  
 USB MIDI 10-4, 10-12, 10-15.  
 USB Port 2-4, 9-9, 9-10, 9-20, 9-24, 10-15, 11-5, 11-6, 11-7,  
   11-8.  
 User Multi 9-30.  
 User Multis 2-15.  
   Deleting. *See* Deleting User Multis.  
   Saving. *See* Multis: Saving.  
 User Objects  
   Deleting all. *See* Files: Delete All.  
 User Programs 2-15.  
   Deleting. *See* Deleting User Programs.  
   Saving. *See* Program: Saving.  
 User Type 10-10.

## V

Value 7-6.  
 Value Jump Buttons 6-6.  
 Variation 3-7.  
 Variation Button 3-6, 3-7, 9-25, B-1, D-4.  
 Variation switch 1-2.  
 VelCurve Parameter 9-14.  
 VelMode Parameter 9-13.  
 Velocity 3-11, 9-26, B-1.  
 Velocity Map 10-8.  
 Velocity Parameter 9-19.  
 VelOffset Parameter 9-13.  
 VelScale Parameter 9-13.  
 View 3-12, 6-9.  
 VOICES 10-18.  
 Volume 1-3, 3-5, 6-14, 9-7, 9-24, 10-19, B-1.  
   Slider 2-2, 2-3.  
 Volume Parameter 6-14, 6-17, 8-10, 8-13, 9-7.

## Z

Zone 3-4, 3-5, 3-16, 4-1, 5-2, 6-13, 6-15, 6-16, 6-17, 6-18,  
   8-1, 8-6 to 8-11, 9-1 to 9-30, 10-15, 10-16, B-1, D-2.  
   Activating. *See* Activating Zones.  
   Muting. *See* Muting Zones.

# KURZWEIL®

It's the sound.®

FLASH⚡PLAY™

©2014 Young Chang Co., Ltd. All rights reserved. Kurzweil® is a product line of Young Chang Co., Ltd. Kurzweil®, Young Chang®, V. A. S. T.®, Forte™, and FlashPlay™ are trademarks of Young Chang Co., Ltd. All other trademarks and copyrights are property of their respective companies. Product features and specifications are subject to change without notice.

U.S. Patents 6,806,413, 6,978,288, 8,263,849

You may legally print up to two (2) copies of this document for personal use. Commercial use of any copies of this document is prohibited. Young Chang Co. retains ownership of all intellectual property represented by this document.

**Part Number 910557-002 Rev. B**

[www.kurzweil.com](http://www.kurzweil.com)