

KURZWEIL

***M-1***

USER'S  
MANUAL

English Manual

**HDC** YOUNG CHANG  
MUSIC

**KURZWEIL**

# ***IMPORTANT SAFETY INSTRUCTIONS***

1. Read these instructions.
2. Keep these instructions.
3. Heed all warnings.
4. Follow all instructions.
5. Do not use this apparatus near water.
6. Clean only with dry cloth.
7. Do not block any of the ventilation openings. Install in accordance with the manufacturer's instructions.
8. Do not install near any heat sources such as radiators, heat registers, stoves, or other apparatus (including amplifiers) that produce heat.
9. Do not defeat the safety purpose of the polarized or grounding-type plug. A polarized plug has two blades with one wider than the other. A grounding type plug has two blades and a third grounding prong. The wide blade or the third prong are provided for your safety. If the provided plug does not fit into your outlet, consult an electrician for replacement of the obsolete outlet.
10. Protect the power cord from being walked on or pinched, particularly at plugs, convenience receptacles, and the point where they exit from the apparatus.



11. Only use attachments / accessories specified by the manufacturer.
12. Use only with a cart, stand, tripod, bracket, or table specified by the manufacturer, or sold with the apparatus. When a cart is used, use caution when moving the cart / apparatus combination to avoid injury from tip-over.
13. Unplug this apparatus during lightning storms or when unused for long periods of time.
14. Refer all servicing to qualified service personnel. Servicing is required when the apparatus has been damaged in any way, such as power-supply cord or plug is damaged, liquid has been spilled or objects have fallen into the apparatus, the apparatus has been exposed to rain or moisture, does not operate normally, or has been dropped.
15. Allow adequate ventilation for the power adapter. Do not hide it under a carpet or behind a curtain or place it in an enclosed space where heat buildup can occur.

**WARNING:** To reduce the risk of fire or electric shock, do not expose this apparatus to rain or moisture. Do not expose this equipment to dripping or splashing and ensure that no objects filled with liquids, such as vases, are placed on the equipment.

To completely disconnect this equipment from the AC Mains, disconnect the power supply cord plug from the AC receptacle.

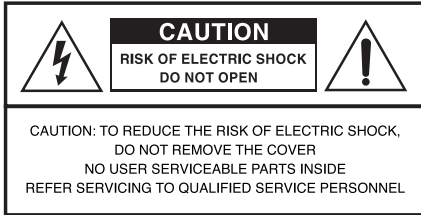

The lightning flash with the arrowhead symbol, within an equilateral triangle, is intended to alert the user to the presence of uninsulated (dangerous voltage) within the product's enclosure that may be of sufficient magnitude to constitute a risk of electric shock to persons.



The exclamation point within an equilateral triangle is intended to alert the user to the presence of important operating and maintenance (servicing) instructions in the literature accompanying the product.

# IMPORTANT SAFETY & INSTALLATION INSTRUCTIONS

## INSTRUCTIONS PERTAINING TO THE RISK OF FIRE, ELECTRIC SHOCK, OR INJURY TO PERSONS

**WARNING :** When using electric products, basic precautions should always be followed, including the following:

1. Read all of the Safety and Installation Instructions and Explanation of Graphic Symbols before using the product.
2. Do not use this product near water—for example, near a bathtub, washbowl, kitchen sink, in a wet basement, or near a swimming pool, or the like.
3. This product should only be used with a stand or cart that is recommended by the manufacturer.
4. This product, either alone or in combination with an amplifier and speakers or headphones, may be capable of producing sound levels that could cause permanent hearing loss. Do not operate for a long period of time at a high volume level or at a level that is uncomfortable. If you experience any hearing loss or ringing in the ears, you should consult an audiologist.
5. The product should be located so that its location or position does not interfere with its proper ventilation.
6. This product should be located away from heat sources such as radiators, heat registers, or other products that produce heat.
7. This product should be connected to a power supply only of the type described in the operating instructions or as marked on the product.
8. This product may be equipped with a polarized line plug (one blade wider than the other). This is a safety feature. If you are unable to insert the plug into the outlet, contact an electrician to replace your obsolete outlet. Do not defeat the safety purpose of the plug.
9. The power supply cord of the product should be unplugged from the outlet when left unused for a long period of time. When unplugging the power supply cord, do not pull on the cord, but grasp it by the plug.
10. Care should be taken so that objects do not fall and liquids are not spilled into the enclosure through openings.
11. The product should be serviced by qualified service personnel when:
  - A. The power supply cord or the plug has been damaged;
  - B. Objects have fallen, or liquid has been spilled into the product;
  - C. The product has been exposed to rain;
  - D. The product does not appear to be operating normally or exhibits a marked change in performance;
  - E. The product has been dropped, or the enclosure damaged.
12. Do not attempt to service the product beyond that described in the user maintenance instructions. All other servicing should be referred to qualified service personnel.
13. **WARNING :** Do not place objects on the product's power supply cord, or place the product in a position where anyone could trip over, walk on, or roll anything over cords of any type. Do not allow the product to rest on or be installed over cords of any type. Improper installations of this type create the possibility of a fire hazard and/or personal injury.

---

## RADIO AND TELEVISION INTERFERENCE

**WARNING :** Changes or modifications to this instrument not expressly approved by KURZWEIL could void your authority to operate the instrument.

**IMPORTANT :** When connecting this product to accessories and/or other equipment use only high quality shielded cables.

**NOTE :** This instrument has been tested and found to comply with the limits for a Class B digital device, pursuant to Part 15 of the FCC Rules. These limits are designed to provide reasonable protection against harmful interference in a residential installation. This instrument generates, uses, and can radiate radio frequency energy and, if not installed and used in accordance with the instructions, may cause harmful interference to radio communications. However, there is no guarantee that interference will not occur in a particular installation. If this instrument does cause harmful interference to radio or television reception, which can be determined by turning the instrument off and on, the user is encouraged to try to correct the interference by one or more of the following measures:

The normal function of product may be disturbed by strong electro magnetic

interference. If so, simply reset the product to resume normal operation by following the instruction manual.

In case the function could not resume, please use the product in other location.

- Reorient or relocate the receiving antenna.
- Increase the separation between the instrument and the receiver.
- Connect the instrument into an outlet on a circuit other than the one to which the receiver is connected.
- If necessary consult your dealer or an experienced radio/television technician for additional suggestions.

**NOTICE :** This apparatus does not exceed the Class B limits for radio noise emissions from digital apparatus set out in the Radio Interference Regulations of the Canadian Department of Communications.

**AVIS :** Le présent appareil numérique n'émet pas de bruits radioélectriques dépassant les limites applicables aux appareils numériques de la class B prescrites dans le Règlement sur le brouillage radioélectrique édicté par le ministère des Communications du Canada.

# SAVE THESE INSTRUCTIONS

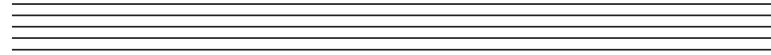

Chapter 1	Front Panel .....	6	Chapter 9	Rhythm List .....	20
	Main Buttons .....	6	Chapter 10	Recording .....	21
Chapter 2	Main Features .....	7		Recording a Performance ....	21
	Main Features .....	7	Chapter 11	Demo Songs .....	22
Chapter 3	Piano Assembly .....	8		Listening to Demo Songs .....	22
	1. Piano Assembly .....	8	Chapter 12	Pedals .....	23
	2. Applying Power .....	11		1. Pedals .....	23
	3. Setting the Volume .....	11		2. Using the Pedals .....	23
Chapter 4	Selecting Sounds .....	12	Chapter 13	MIDI .....	24
	1. Selecting Sounds .....	12		1. MIDI Channel .....	24
Chapter 5	Layering .....	14		2. Connecting to a Computer	24
	1. Layering Two Sounds .....	14	Chapter 14	Connection .....	26
Chapter 6	Splitting .....	15		1. Using Headphones .....	26
	1. Splitting the Keyboard .....	15		2. Aux In .....	26
Chapter 7	Functions .....	17		3. Aux Out .....	26
	1. Function Mode .....	17		4. MP3 Aux In .....	26
	2. Selecting a Function .....	17	Chapter 15	Demo Song List .....	27
Chapter 8	Rhythm .....	18	Chapter 16	Specifications .....	28
	1. Selecting a Rhythm .....	18			

# Chapter 1 Front Panel

## Main Buttons

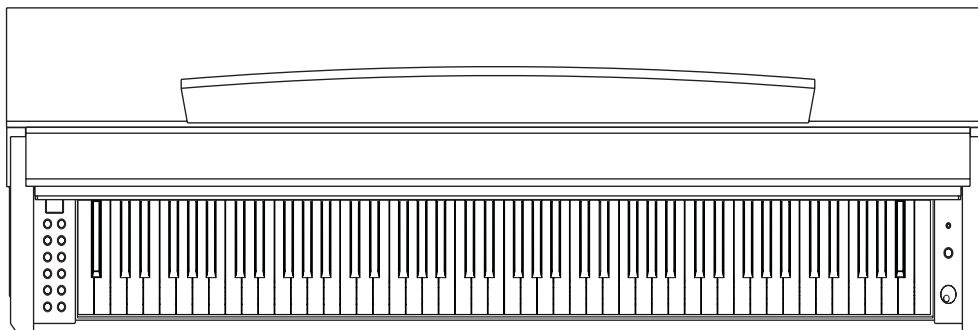

### Text

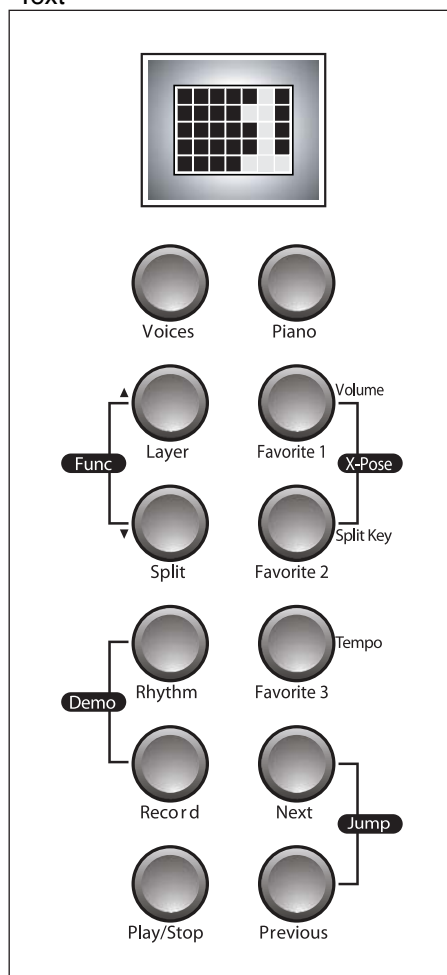

- (1) Voice button  
Select among the 20 voices with the [Voices] button.
- (2) Piano button  
Always selects "1 GRAND PIANO" sound.
- (3) Favorite 1,2,3 buttons  
Provides quick access to 3 user selected or modified voices.
- (4) Rhythm button  
Select among the 29 rhythms with the [Rhythm] button.
- (5) Layer button  
You can layer two voices and play them simultaneously to create a thicker and richer sound.
- (6) Split button  
For playing different voices on the left-hand and right-hand section of the keyboard.
- (7) Demo Songs  
Select among the 50 demonstration songs.
- (8) Function button  
You may set functions like Tune, Tempo, Metronome, etc.
- (9) Record button  
For recording your keyboard performance.
- (10) Play/Stop button  
These control playback of or stop the demonstration songs and your recorded songs.
- (11) Next button  
Select the next higher Voice, Rhythm, or Demo Song, etc.
- (12) Previous button  
Select the next lower Voice, Rhythm, or Demo Song, etc.

Thank you for purchasing the KURZWEIL's Digital Piano. We recommend that you read this manual carefully so that you can fully take advantage of the advanced and convenient functions of the KURZWEIL's Digital Piano.

### Main Features

- 88 note fully weighted Graded Hammer action keyboard
- 3 Pedals (Sustain, Sostenuto, Soft)
- 10 Touch sensitivity settings
- Stereo Audio Input, Output
- 2 Headphone jacks
- USB MIDI
- 5x7 Dot scrolling matrix LED
- 20 Voices
- 29 Rhythm patterns
- Transpose, Tune functions
- Layer, Split mode
- Recording function
- MP3 Aux In

# Chapter 3 Piano Assembly

Check that all of the following items are present.

Part Name	Q'ty	Part Name	Q'ty
① Keyboard	1 EA	⑥ Screws for side panel and keyboard (25mm)	4 EA
② Side panel of stand (Left)	1 EA	⑦ Screws for side panel and pedal box (25mm)	4 EA
③ Side panel of stand (Right)	1 EA	⑧ Screws for side panel and rear panel	4 EA
④ Pedal box	1 EA	⑨ Screws for rear panel	4 EA
⑤ Rear panel	1 EA	⑩ Cord holder	2 EA

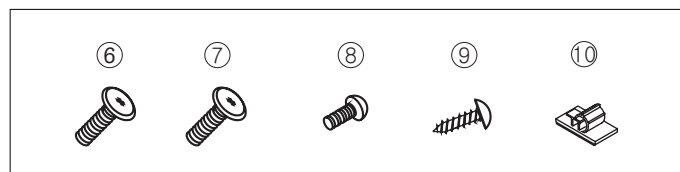
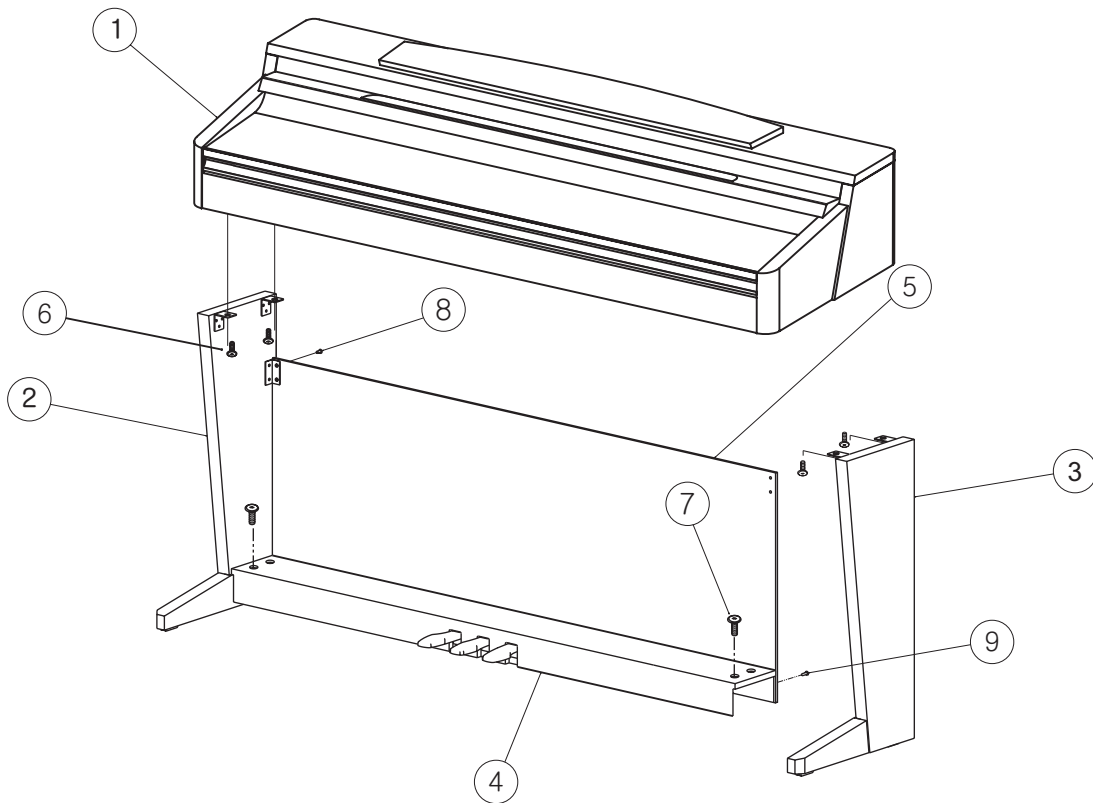

Please check the quantity of related part number.



# Chapter 3 Piano Assembly

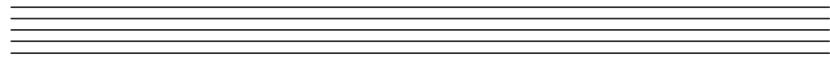

## 1. Stand Assembly



- Assembly should be carried out by at least two persons.
- Assemble the stand on a hard and flat floor with ample space.
- Be sure to use the included screws, and insert screws of the correct size in the correct hole locations. Use of incorrect screws can damage the product.

### 1) Side Panel and Pedal Box assembly

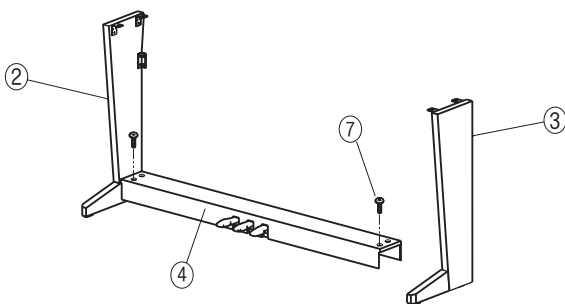

1. Place the pedal box ④ on the left side panel ② and use ⑦ screws to fasten the side panel.
2. Place the pedal box ④ on the right side panel ③ and use ⑦ screws to fasten the side panel.
3. You can find the pedal cable in the pedal box ④. Untie and straighten out the bundled pedal cable.

### 2) Rear Panel assembly

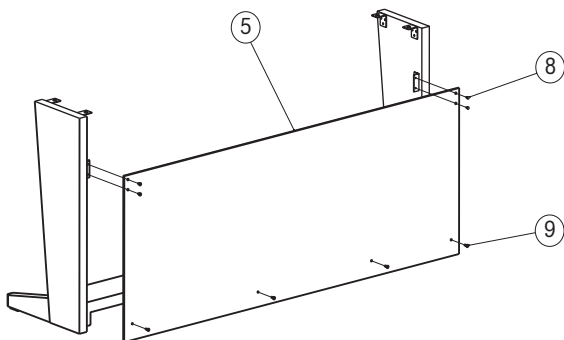

1. Fit into the rear panel's hole in the side panel brackets and then use the screws ⑧ to fasten the rear panel.
2. Use the screws ⑨ to fasten the bottom of the rear panel.

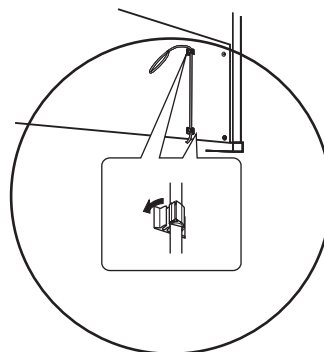

Attach the pedal cord holders to the rear panel as shown, then clip the cord into the holders

---

---

---

### 3) Mounting the keyboard

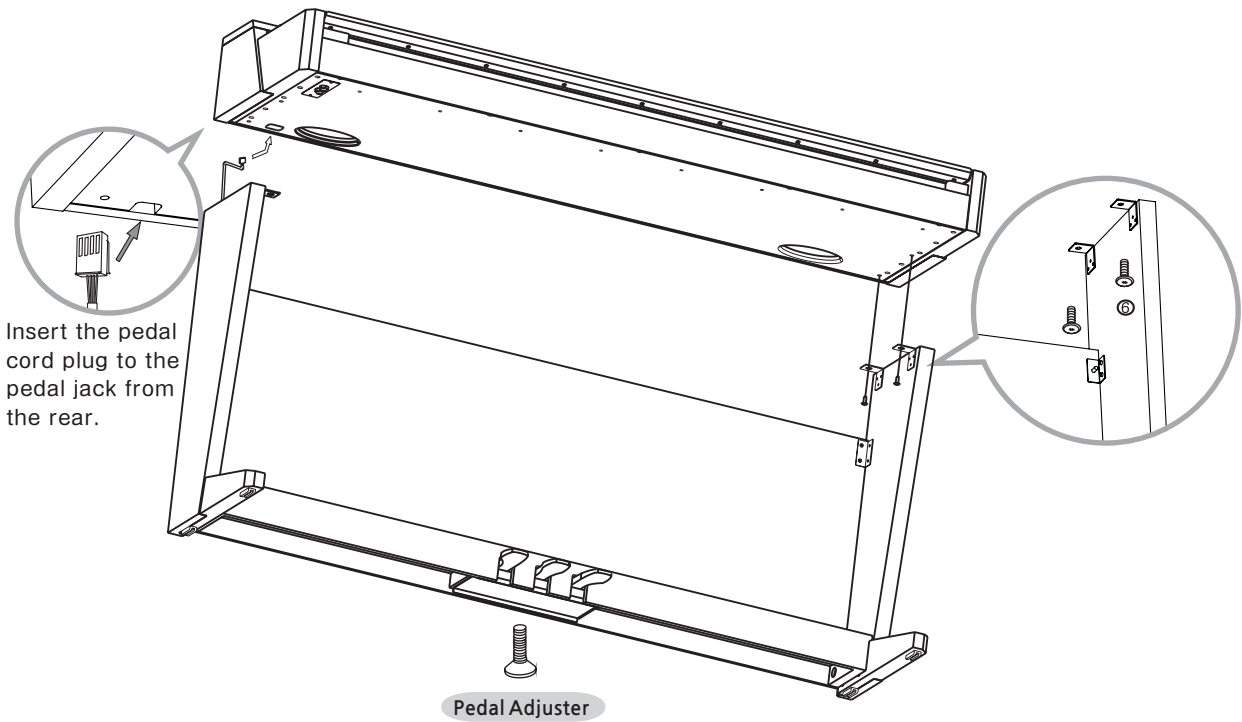

1. Place the keyboard on the stand and fit into the holes in the side panel brackets.
2. Fasten the keyboard to the side panel using screws ⑥.
3. Insert the pedal cable plug into the pedal jack located on the bottom of the keyboard.

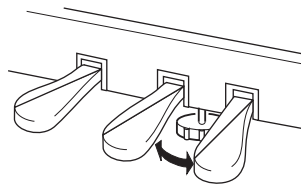

4. Rotate the pedal adjuster until it comes in firm contact with the floor surface.  
If the adjuster is not in firm contact with the floor, the pedals will wobble and may malfunction.

---

---

---

## 2. Applying Power

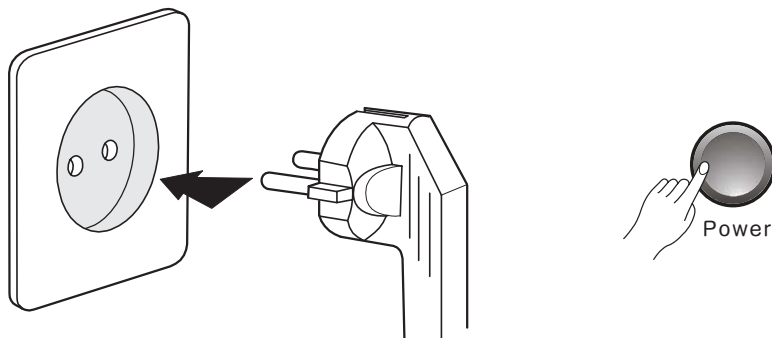

### 1) Connecting the power cord

First insert the plug of the AC power cord into the AC connector on the Adaptor, then plug the other end of the cord into the proper AC outlet on the wall. In some areas a plug adaptor may be provided to match the pin configuration of the AC wall outlets in your area.

2) Plug the thin DC power cord into the DC Power Jack on the back of the piano.

### 3) Turn the power on

Press the power switch located on the right of the front panel to turn the power on. The display located in the center of the front panel should light with various patterns and after a short time display "GRAND PIANO".

#### CAUTION

Even when the instrument is turned off, AC power is still flowing to the adapter at a minimum level. When you are not using the instrument for a long time or during electrical storms, unplug the AC power cord from the wall outlet.

## 3. Setting the Volume

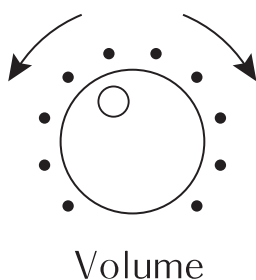

To adjust the volume, use the [Volume] knob located at the right of front panel. Play the keyboard while you adjust the knob to a comfortable and realistic volume.

#### NOTE

Adjusting the [Volume] knob also affects the output level of the Phones jacks and the output level of the Audio Out jacks.

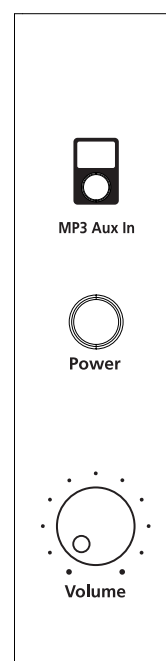

## 1. Selecting Sounds

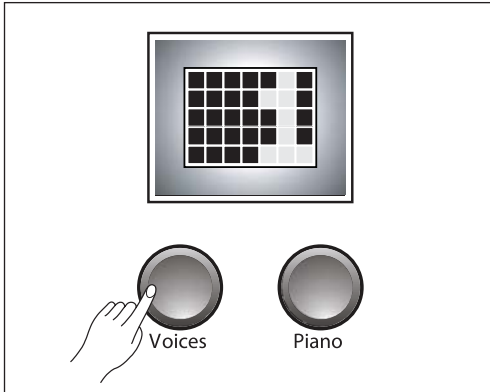

There are two ways of selecting one of the 20 voices : with the [Voices] button and the piano keys.

- 1) Press the [Voice] button.  
Then use the [Next] or [Previous] button to select different voices in sequence.
- 2) Press and hold the [Voice] button.  
Then press and release any keys between A0 and E2.  
Release the [Voice] button.  
Please refer to the table on the next page which contains the list of all available voices and their assigned keys.

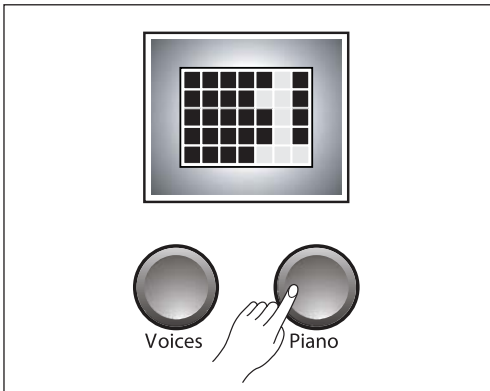

If you want to play the Grand Piano voice immediately, press the [Piano] button to set current voice to "1 GRAND PIANO".

Regardless of the method you use, notice that the voice number and name scrolls across the display followed by the voice number again. You need not wait for the scrolling to finish before making another selection.

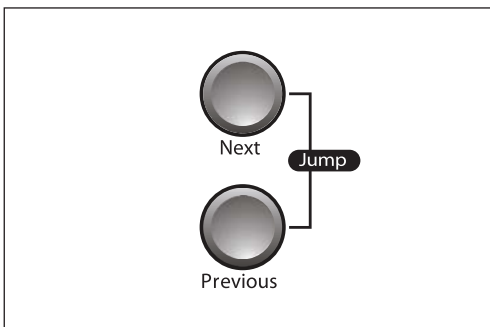

If you hold down the [Next] or [Previous] buttons, the voice numbers will begin to change quickly after a short delay.

If you press the [Next] and [Previous] together, it will skip to the first voice in the next category of voices.

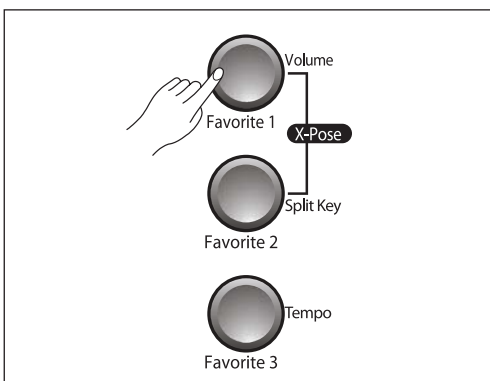

To save a voice for quick selection, hold down any of the [Favorite 1], [Favorite 2] or [Favorite 3] buttons for 2 seconds.

Your new voice will be saved and can be recalled at any time by pressing the same Favorite button again. For example, if you choose the [Favorite 1], then "F1" will be displayed.

## 2. List of Voices

The voices with name consisting of two different instruments with "+" between them such as "3 Piano + Str" or "13 Horn + Str" are preset layered combination of two voices.

No.	Voice	Keys
1	Grand Piano	A 0
2	Jazz Piano	A# 0
3	Piano + Str	B 0
4	Stevie's EP	C 1
5	Classic DX	C# 1
6	FM E.Piano	D 1
7	Harpsichord	D# 1
8	Sweet Organ	E 1
9	Pipe Stops	F 1
10	Tenor Sax	F# 1
11	Flute	G 1
12	Oboe	G# 1
13	Horns + Str	A 1
14	Adagio Str	A# 1
15	Full Choir	B 1
16	Acoustic Guitar	C 2
17	Nylon Guitar	C# 2
18	Marimba	D 2
19	Solid Kit	D# 2
20	Percussion	E 2

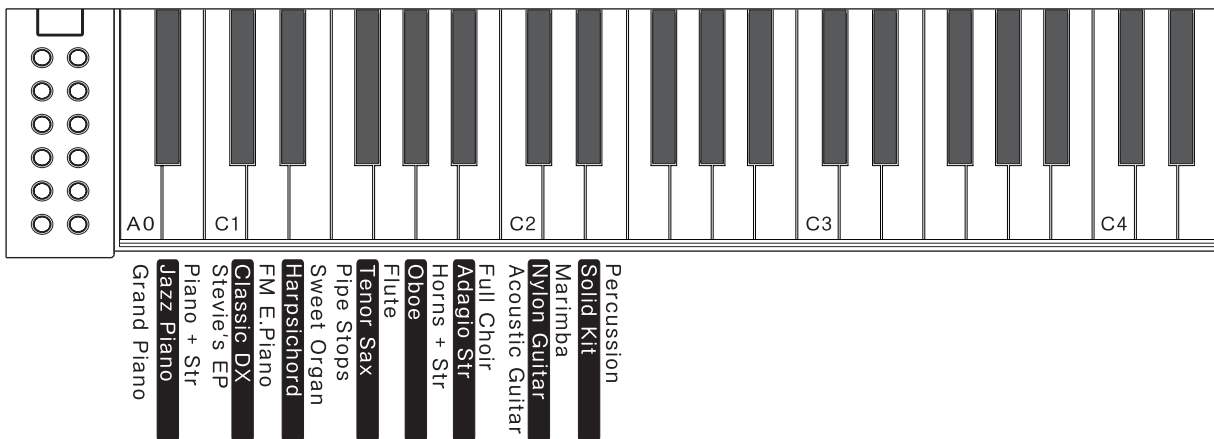

## 1. Layering Two Sounds

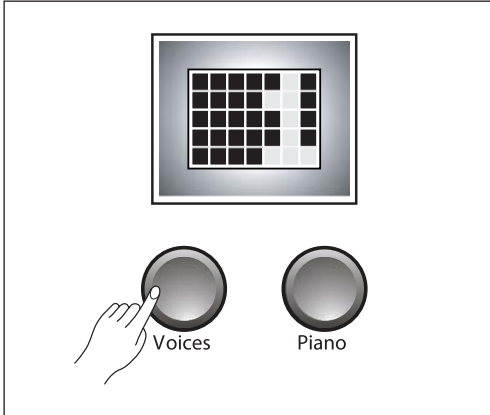

This function lets you layer and play two different sounds at the same time. You can layer voices of two different voices in the same category, and create a composite voice of greater richness and texture.

Select the first voice in the usual way with the [Voices] button, the [Next] or the [Previous] button.

Or, directly select a voice by holding the [Voices] button down and pressing a key assigned to the desired voice. Please refer to the voice list on page 13.

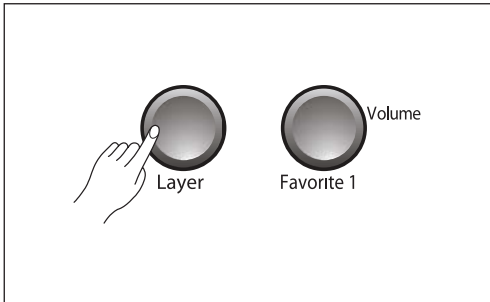

Then press the [Layer] button and use the [Next] or the [Previous] button to select a voice to be layered with the first one.

Alternatively, hold the [Layer] button down and press a key to directly select a layer voice while the LED is blinking.

The default layer voice is "14 Adagio Str".

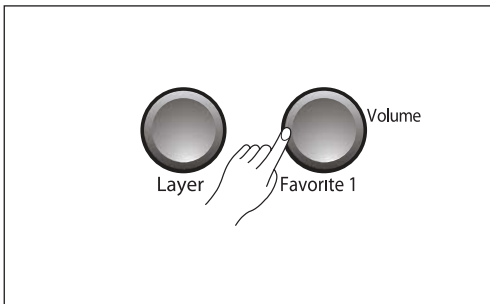

### Setting the Layer Volume

If you want, use the [Volume] button to adjust the volume balance between two voices in layer mode.

This parameter determines the relative volumes of the Primary and Secondary Sounds – it can be set to any number between -9 and 9. By default, the Layer Volume is set to -3, which results in the secondary sound being a little softer than the primary sound.

When set to a positive number, the volume for the Secondary Sound is increased while the volume for the Primary Sound is decreased – doing the opposite has the opposite effect on the relative volumes of the layers

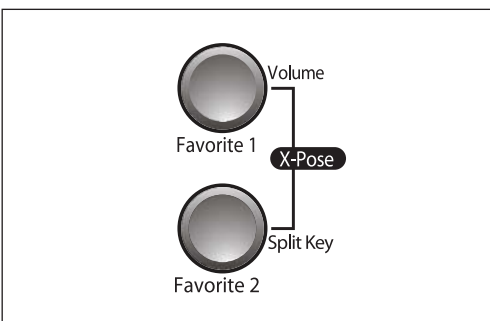

### Layer Transposition

This parameter determines the transposition of the Secondary Sound relative to that of the Primary Sound – it can be set to -24, -12, 0, 12, and 24.

In layer mode, press the [X-Pose] button, then press the [Previous] or [Next] buttons to adjust the Layer Transposition.

## 1. Splitting the Keyboard

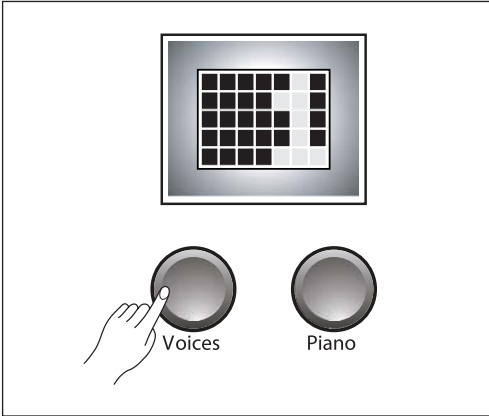

Split mode enables you to play two different voices on the keyboard – one with the left hand and another with the right hand. For example, you can play a bass part using the Bass voice with the left hand and a melody voice with the right hand.

Select the first voice in the usual way with the [Voices] button, the [Next] or the [Previous] button.

Or, directly select a voice by holding the [Voices] button down and pressing a key assigned to the desired voice. Please refer to the voice list on page 13.

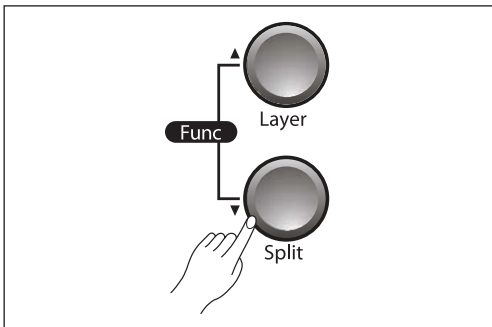

Then press the [Split] button and use the [Next] or the [Previous] button to select a split voice.

Alternatively, hold the [Split] button down and press a key to directly select a split voice while the LED is blinking.

The default split voice is "4 Stevie's EP".

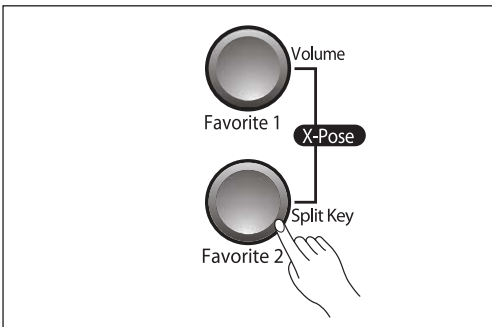

### Split point

By default the split point is just above F#3. To change the split point, use the [Split Key] special button.

While the keyboard is split, press the [Split Key] button and the LED will first display "F#3" which is the default.

To change, press the [Next] or [Previous] button until the display shows the desired split point.

The [Jump] button pair will reset the split point back to "F#3".

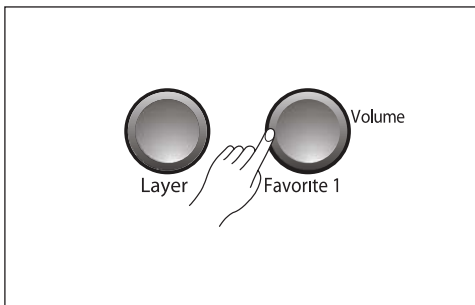

### Setting the Split Volume

If you want, use the [Volume] button to adjust the volume balance of the two voices in split mode.

First press the [Volume] button and the LED will display "0" by default, which means the bass voice and the treble voice are at the same volume level.

Use the [Next] button and the [Previous] button to adjust the relative volume level. Press the [Jump] button pair to reset the volume balance to "0".

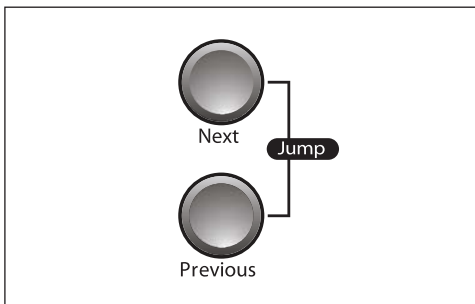

The range for the volume balance is between -9 and 9. Negative digits make the bass voice relatively louder, while positive digits make the treble voice relatively louder.

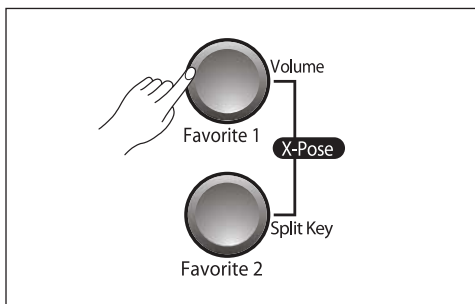

### Split Transpose

The lower voice can be transposed. In split mode, press the [X-Pose] button pair and the LED will first display "0".

Then use the [Next] button and [Previous] button to transpose the lower voice by octaves (12 semitone is an octave).

The [Jump] button pair will reset the transposition. The range for transposition is from 2 octaves down to 2 octaves up (-24 to 24 semitones).

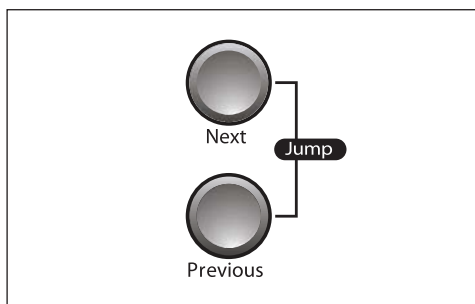



## 1. Function Mode

- 1) Transpose
- 2) Effect Level
- 3) Touch Sensitivity
- 4) Fine Tuning
- 5) MIDI Channel
- 6) Metronome
- 7) Local Control
- 8) Version
- 9) Hard Reset

## 2. Selecting a Function

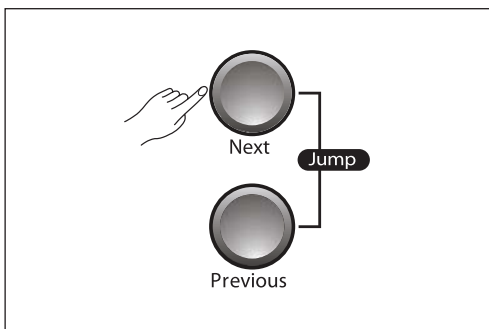
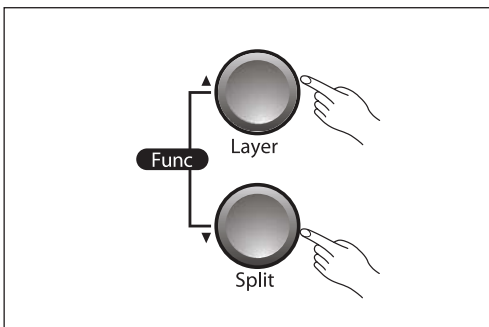

To go to Function Mode, press the [Func] button pair (press [Layer] and [Split] button together). The display will show "0 TRANSPOSE" which indicates the transpose setting. The number displayed is the current setting of the parameter. To change the parameter setting, use the [Next] button and the [Previous] button. Press the [Layer] or [Split] button to move to the next or the previous parameter. When you want to quit Function Mode, press the [Voices] or [Piano] button.

---

---

---

## 1) Transpose

You can use the Transpose parameter to transpose the entire keyboard in semitone intervals. The range is between -24 to 24. The [Jump] button pair will reset the transposition to 0.

## 2) Effect Level

You can adjust the intensity of the reverberation or other effect used by each voice. Normal is 20% but that can be adjusted by using the [Next] and [Previous] buttons. The range is from 0%(no effect) to 100%(maximum effect). The [Jump] button pair will restore the normal setting of 20%.

## 3) Touch Sensitivity

You can adjust how the keyboard responds to your playing. The default is Linear which offers the greatest dynamic range.

Linear	Greatest dynamic range, best compromise for all instruments.
Light 1, 2, 3	Progressively lighter touch is needed for loud dynamics.
Hard 1, 2, 3	Progressively lighter touch is needed for loud dynamics
Piano	Best for Piano dynamics.
Easy	Light, easy touch for younger player.
GM Receive	Use this when playing General MIDI songs.

## 4) Fine Tuning

You can finely tune the pitch up or down by 1 cent (1/100 semitone) steps. This function is useful when you play or record with another instrument that is slightly out of tune or can't be easily retuned. The default setting is "0" (A4=440Hz). The range is -100 (1 semitone flat) to 100 (1 semitone sharp).

## 5) MIDI Channel

You can select a MIDI Channel from 1~9 or 11~15 for MIDI output and recorder. Channel 10 used for playing rhythm patterns and channel 16 is for the metronome.

## 6) Metronome

There are three settings for the internal metronome. The "On" value plays when you are performing or recording. The "Rec" value plays only when you are recording. The "Off" value turns off the metronome.

## 7) Local Control

You can set Local Control on or off here. Local Control is the connection between keyboard and internal sound producing circuitry (engine). When Local Control is set to On, the keyboard delivers your performance information to the sound engine, so you can hear the sounds you play. At the same time, the M-1 transmits MIDI information via its USB port.

There are, however, cases you need to set Local Control to Off. When using the M-1 with an external MIDI sequencer or computer via MIDI, the M-1 may play the same note twice—once by the direct sound engine connection and once by the "echo" through the sequencer and coming back. You can eliminate the echoing of notes by setting Local Control to Off which interrupts the direct connection. The default setting is "On".

## 8) Version

You can find the software version information with this function.

The format is : "OS:1.00.441M Obj:0.00.5" on LED. The display will scroll to show all of the information. The "OS" is current OS version and "Obj" is current sound object version.

## 9) Hard Reset

This function will initialize the keyboard and erase its memory. The LED will display "Hard Reset?" Press the [Next] button and the LED will display "Confirm?" Press the [Next] button again to confirm and execute the hard reset. The M-1 will then erase its memory, restore the factory settings, and reboot.

This instrument features a variety of rhythmic backing patterns (called "rhythms") in a variety of different musical genres including pop, jazz and many others.

## 1. Selecting a Rhythm

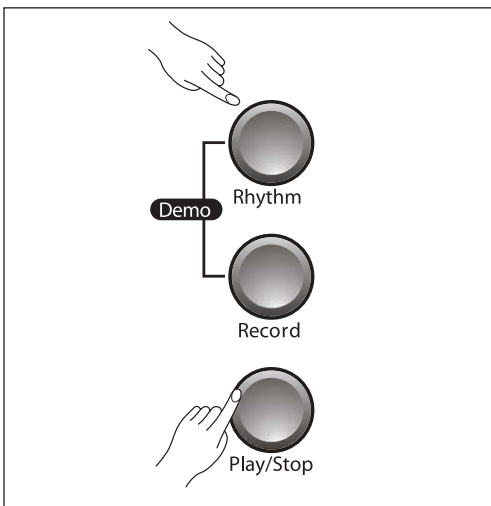

To select a rhythm, press the [Rhythm] button. The LED will display the currently selected preset rhythm pattern number.

Choose different preset patterns with the [Next] and [Previous] buttons.

Alternatively, hold the [Rhythm] button down and press a key to directly select a rhythm while the LED is blinking.

Pressing the [Play/Stop] button will start the rhythm pattern playback. Pressing the same button again will stop the playback.

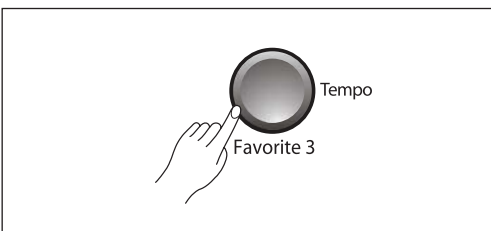

Change the rhythm tempo by pressing the [Tempo] button. The [Next] and [Previous] buttons will speed up or slow down the tempo. The [Jump] button pair will restore the default tempo (120 beats/minute).

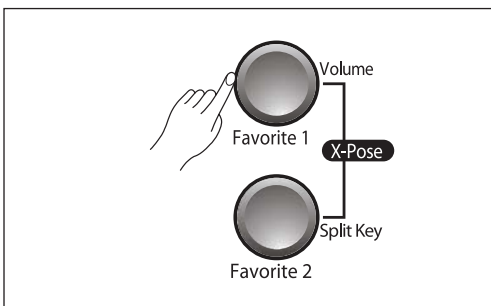

Use the [Volume] button then the [Previous] and [Next] buttons to adjust the volume level of the rhythm. The range is from the 1 to 9 and the default is 9 (max).

# Chapter 9 Rhythm List

No.	Rhythm Pattern	Key
1	Ballad 1	A0
2	Ballad 2	A#0
3	Ballad 3	B0
4	Country 1	C1
5	Country 2	C#1
6	Country 3	D1
7	Jazz 1	D#1
8	Jazz 2	E1
9	Jazz 3	F1
10	Latin 1	F#1
11	Latin 2	G1
12	Latin 3	G#1
13	Pop 1	A1
14	Pop 2	A#1
15	Pop 3	B1
16	R&B / Dance 1	C2
17	R&B / Dance 2	C#2
18	R&B / Dance 3	D2
19	Rock 1	D#2
20	Rock 2	E2
21	Rock 3	F2
22	World 1	F#2
23	World 2	G2
24	World 3	G#2

No.	Rhythm Pattern	Key
25	Metro MP 1/4nt	A2
26	Metro MP 1/8nt	A#2
27	Metro MP 1/16nt	B2
28	Metro MP 3/4	C3
29	Metro MP 6/8	C#3
30	NoDrumSong	D3
31	User Song 1	D#3
32	User Song 2	E3
33	User Song 3	F3
34	User Song 4	F#3

The diagram shows a piano keyboard layout with 34 numbered buttons. The buttons are arranged in a row across several octaves, with labels A0, C1, C2, C3, and C4 indicating the starting notes of the octaves. The buttons are labeled with their respective rhythm patterns and keys.

Button No.	Rhythm Pattern	Key
1	Ballad 1	A0
2	Ballad 2	A#0
3	Ballad 3	B0
4	Country 1	C1
5	Country 2	C#1
6	Country 3	D1
7	Jazz 1	D#1
8	Jazz 2	E1
9	Jazz 3	F1
10	Latin 1	F#1
11	Latin 2	G1
12	Latin 3	G#1
13	Pop 1	A1
14	Pop 2	A#1
15	Pop 3	B1
16	R&B / Dance 1	C2
17	R&B / Dance 2	C#2
18	R&B / Dance 3	D2
19	Rock 1	D#2
20	Rock 2	E2
21	Rock 3	F2
22	World 1	F#2
23	World 2	G2
24	World 3	G#2
25	Metro MP 1/4nt	A2
26	Metro MP 1/8nt	A#2
27	Metro MP 1/16nt	B2
28	Metro MP 3/4	C3
29	Metro MP 6/8	C#3
30	NoDrumSong	D3
31	User Song 1	D#3
32	User Song 2	E3
33	User Song 3	F3
34	User Song 4	F#3

You can record and playback your performance much like a tape recorder. This function can greatly enhance your composition and performance results.

## 1. Recording a Performance

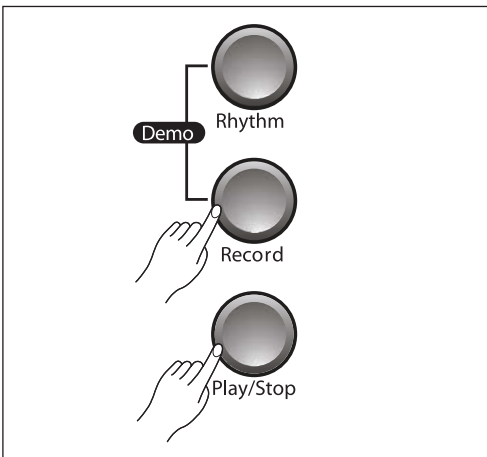

- 1) Press the [Rhythm] button then select a rhythm using the [Next] and [Previous] buttons or the "[Rhythm] button + key" method.

If you do not want to record with a rhythm, select No. 30 "NoDrumSong" as the rhythm (see page 20).

- 2) Press the [Record] button. The display will scroll "BEGIN RECORDING".
- 3) Then press the [Play/Stop] button. The selected rhythm will begin playing and the recording will begin immediately. Or, if the metronome is enabled, a lead in count of one measure will be heard before recording begins.
- 4) Play your performance then press the [Play/Stop] again to stop recording.
- 5) Now the display will scroll "PRESS RECORD TO SAVE AS U1". You can use the [Next] or [Previous] buttons to select the User Recording (from U1 to U4) to store the recorded song into. Then, press the [Record] button to store the song, or any other button to exit the recording.
- 6) To delete recorded songs, execute "Hard Reset" in the Function Mode.

## 2. Notes about Recording

You can easily replace all or part of a saved User Song. First, select the User Song (U1 to U4) that you'd like to modify.

- 1) To record over your song from the beginning:  
Press the [Record] button and then the [Play/Stop] button.  
Your new performance will replace the existing one from the beginning until you press the [Play/Stop] button.
- 2) To replace only part of your song:  
Press the [Play/Stop] button and listen to your song.  
When you come to the part you want to replace, Press the [Record] button and play your new part. The M-1 will continue to erase all the notes that were present in the song until you press the [Play/Stop] button again to exit recording.

## 1. Listening to Demo Songs

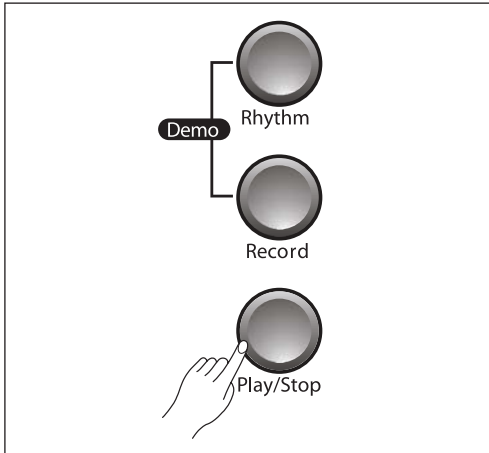

- 1) Press the [Demo] button to enter the demo mode.  
(Press the [Record] and [Play/Stop] buttons at the same time to access the demo song)
- 2) To select a demo song, press the [Next] or [Previous] value button. (Refer to the demo song list on page 27.)
- 3) Press the [Play/Stop] button to start playback.
- 4) Alternatively, you can select a song by pressing a key, then playback will start immediately.
- 5) Press the [Play/Stop] button again to stop playback.

You can set a playback mode such as Off or On for demo repeat. Press the [Jump] button pair while playing a demo song.

- 1) Off : Demo songs only play once.
- 2) On : Repeat playing of all songs.

The LED display will show the name and number of the demo song currently playing.

## 1. Pedals

This piano has three foot pedals : damper(sustain) pedal (right), sostenuto pedal (center) and soft pedal (left) that produce a range of expressive effects similar to those produced by the pedals of an acoustic piano.

## 2. Using the Pedals

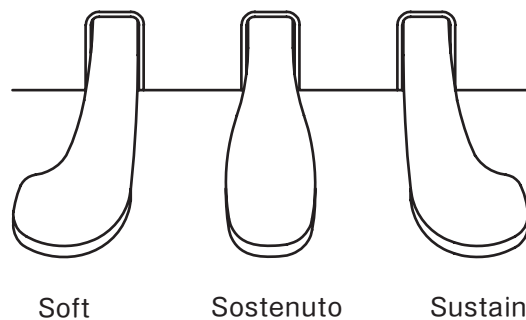

### 1) Sustain pedal

The sustain pedal functions in the same way as a damper pedal on an acoustic piano. When the damper pedal is pressed, notes sustain longer. Releasing the pedal immediately stops any sustained notes.

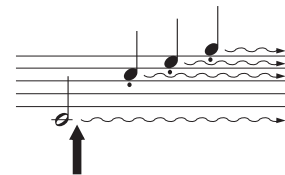

When you press the sustain pedal here, the notes you play before you release the pedal sustain longer.

### 2) Sostenuto pedal

If you play a note or chord on the keyboard and press the sostenuto pedal while the notes are held, those notes will sustain as long as you hold the pedal (as if the damper pedal had been pressed) but all subsequently played notes will not be sustained. This makes it possible to sustain a chord, for example, while other notes are played "staccato".

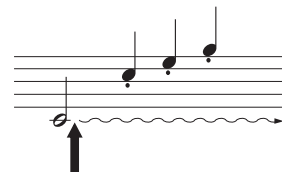

When you press the sostenuto pedal here while holding the note, the note will sustain as long as hold the pedal.

### 3) Soft pedal

The soft pedal reduces the volume and slightly changes the timbre of notes played while the pedal is pressed. The soft pedal will not affect notes that are already playing when it is pressed.

**NOTE** If the pedal doesn't work, make sure that the pedal cord is properly plugged into the main unit (see page 10). Also, avoid pressing any pedals while the piano booting.

MIDI is acronym for Musical Instrument Digital Interface, which is an industry standard protocol for electronic instruments to communicate with each other.

### 1. MIDI Channel

A MIDI cable can transmit multiple channels of performance data which is similar to TV channels. Each channel can be assigned its own voice. Typical MIDI instruments can play up to 16 channels at the same time which is equivalent to 16 soloists.

#### NOTE

If you want to use your piano and record your performances with a computer, a sequencer program must be installed on your computer.

### 2. Connecting to a Computer



Type A



Type B

The instrument can be connected to the computer via a USB cable (AB type USB cable of less than 3 meters).

Connect the USB cable to the USB Type B terminal of the instrument, then to the USB Type A terminal of the computer.



## MIDI Implementation Chart

Manufacturer:

Young Chang  
Digital Piano

Date : 2/15/2013

Version 1.0

Function	Transmitted	Recognized	Remarks
Basic Channel	Default	1	Memorized
	Changed	1 - 16	
Mode	Default	Mode 3	Use Multi mode for multi-timbral applications
	Messages		
	Altered		
Note Number		0 - 127	
	True Voice	0 - 127	
Velocity	Note ON	O	
	Note OFF	O	
After Touch	Keys	X	
	Channels	X	
Pitch Bender		X	
Control Change	O	0 - 31	
		32 - 63 (LSB) 64 - 127	
Program Change	O	0 - 19	
	True #	0 - 127	
System Exclusive ID : 18		O	O*
System Common	Song Pos.	O	O
	Song Sel.	O	O
	Tune	X	X
System Real Time	Clock	O	O
	Messages	O	O
Aux Messages	Local Control	X	O
	All Notes Off	X	O
	Active Sense	X	X
	Reset	X	X
Notes * Kurzweil manufacturer's ID is 07.			

# Chapter 14 Connection

## 1. Using Headphones

Connect a pair of headphones to one of the phones jacks. Two phones jacks are provided. You can connect two sets of standard stereo headphones. (If you are using one pair headphones, you can plug them into either of these jacks).

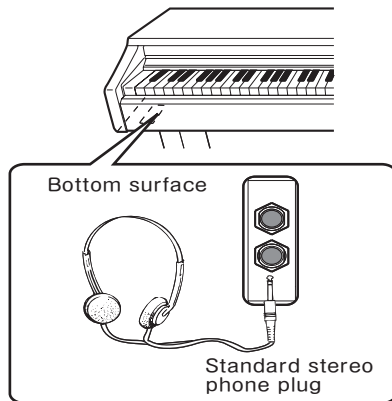

### CAUTION

Do not use headphones at a high volume for an extended time. Doing so may cause hearing loss.

## 2. Audio In (Aux In)

You can connect the output jacks of an external device (such as CD player, tone generator) to the instrument's Aux In jacks, letting you hear the sound of that device through the built-in speakers of the instrument.

## 3. Audio Out (Aux Out)

You can connect a stereo system to amplify the instrument's sound by using the Aux Out jacks. When the instrument's sound is output to an external device, first turn on the power to the instrument, then to the external device. Reverse this order when you turn the power off.

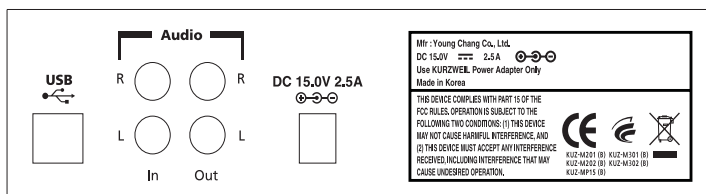

## 4. MP3 Aux In

You can connect the output jack of an MP3 player or smart phone to the instrument's MP3 Aux In jack on the right side of the front panel.



# Chapter 15 Demo Song List

1		Prelude I BWV 846	J.S.Bach
2		Invention No.4	J.S.Bach
3		Invention No.8	J.S.Bach
4	BMV 847	Prelude II BWV 847	J.S.Bach
5		ARIA Goldenberg-Variationen BMW 988	J.S.Bach
6	BMV 848	Fuga II (A3 VOCl)	J.S.Bach
7	Op36, No4	Sonatine Op.36 No.4	M.Clementi
8	K15v	Klavierstück K. 15v	W.A. Mozart
9	K333	Piano Sonate K.333 1st mov.	W.A. Mozart
10	K485	Rondo in D-dur K.485	W.A. Mozart
11		Piano Sonate K.331 Rondo Turkish March	W.A. Mozart
12	K545	Piano Sonate K.545 1st mov.	W.A. Mozart
13		Minuette in G	L.v. Beethoven
14		Bagatelle No.25 Fur Elise	L.v. Beethoven
15	Op55, No. 1	Sonatine Op.55 No.1	Fr.Kuhlau
16		March Militaire Op.51 No.1	F.P.Schubert
17	Op94 - 3	Moments Musicaux 3.	F.P.Schubert
18	Op90 - 2	Impromptu Op.90 N0.2	F.P.Schubert
19	Op90 - 4	Impromptu Op.90 N0.4	F.P.Schubert
20		La chevaleresque	J.F.Buramu ler
21	Op38.No.2	Without words song Op.38 No.2	J.L.F.Mendelssohn
22	Op30.No.6	Venetianisches Zgondellied	J.L.F.Mendelssohn
23	KK Ivb-10	Sostenuto	F.F.Chopin
24	KK Ivb-11	Valse KK IVB-11	F.F.Chopin
25	Op.7.No.1	5 Mazurkas I Op.7 N0.1	F.F.Chopin
26	Op.69-2	Valse Op.69 No.2	F.F.Chopin
27	Op18	Grande Valse Brillante Op.18	F.F.Chopin
28		Valse Op.64. No.2	F.F.Chopin
29	Op9. No.2	Noctutne Op.9 N0.2	F.F.Chopin
30	Op64 No.1	Valse Op.64 No.1	F.F.Chopin
31	Op28.No.15	Preludes in Db Maior Op.28 No.15	F.F.Chopin
32	Op66	Fantaisie-Impromptu Op.66	F.F.Chopin
33	Op15-7	Traumerei	R. Schumann
34		Frolicher Landmann Op.68-10	R. Schumann
35	Op15	Von fremden Landern und Menschen Op.1	R. Schumann
36		Liebstraume Nr.3	F. Liszt
37		Dolly's Dreaming And Awakening	T. Oesten
38	Op410	Fryhlingsstimmen Op.410	J. Strauss
39		The Swan	Saint-Saens
40		Blumenlied	G. Lange
41		Valsette	F. Borowski
42	Op39, No.16	Old French Air	P.I.Tchaikovsky
43	Op39, No.10	Mazurka	P.I.Tchaikovsky
44		Polka	P.I.Tchaikovsky
45		Barcarolle	P.I.Tchaikovsky
46	Op101-7	Humoreska	A. Dvor A k
47	Op46-3	Suite Peer Gynt Op.46-3 Anitras Tanz	E. Grieg
48	L75	Suite Bergamasque Prelude	C.A.Debussy
49		Reverie	C.A.Debussy
50		Arabesque	C.A.Debussy

## Chapter 16 Specifications

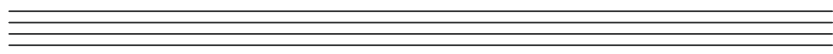

Keyboard	88 note fully weighted Graded Hammer action (A0 ~ C8)
Finish	Simulated Rosewood or White
Cabinet	Pattern type
Tone Gen.	Kurzweil V.A.S.T
Polyphony	64 Voices
Sounds	20 Programs
Rhythm	29 Patterns
Play Mode	Layer, Split
Touch	10 Sensitivity levels
Demo Songs	50 Piano Masterpieces
Sequencer	1 Tracks, 4 Songs
Pedals	3 (Sustain, Soft, Sostenuto)
Display	5 x 7 Dot scrolling matrix LED
Others	Volume, Tune, Transpose, Metronome
Connectors	MP3 Aux In, Audio In/Out, USB Slave
Audio Power	15W x 2, 8 Ohms
Speakers	4.5" x 2 full-range (Oval type)
Dimensions	1408 x 414 x 838 (W x D X H)
Weight	Keyboard : 28.4Kg, Stand : 20.25Kg

**Memo**

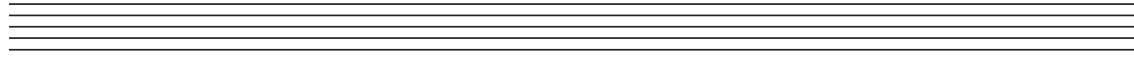

**Memo**

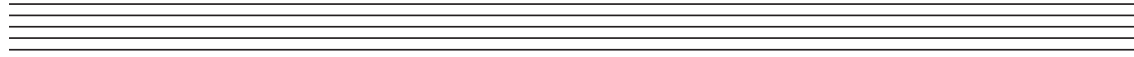

**KURZWEIL**

[www.ycpiano.co.kr](http://www.ycpiano.co.kr)

**KURZWEIL**

**HDC YOUNG CHANG  
MUSIC**

Young Chang North America Kurzweil Home Products  
19060 S Dominguez Hills Dr, Rancho Dominguez, CA 90220  
Tel : (310) 637-2000  
Fax : (310) 637-2025

**Kurzweil Co., LTD**

iPark Building #102, Floor 9 Jeongja-Dong 9, Bundang-Gu  
Soungnam-Shi, Gyeonggi-Do 463-859 South Korea  
[www.ycpiano.co.kr](http://www.ycpiano.co.kr)  
[www.youngchang.com](http://www.youngchang.com)  
[www.kurzweil.com](http://www.kurzweil.com)

**TECHNICAL SUPPORT**

Email : [support@Kurzweil.com](mailto:support@Kurzweil.com)