

KURZWEIL®

Andante

CUP110

USER'S MANUAL

English Manual

YOUNG CHANG

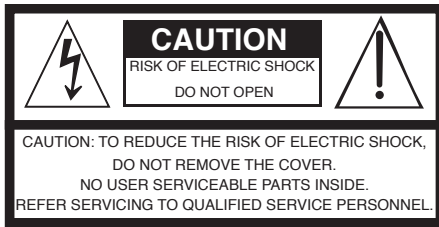

The lightning flash with the arrowhead symbol, within an equilateral triangle is intended to alert the user to the presence of uninsulated "dangerous voltage" within the product's enclosure that may be of sufficient magnitude to constitute a risk of electric shock to persons.



The exclamation point within an equilateral triangle is intended to alert the user to the presence of important operating and maintenance (servicing) instructions in the literature accompanying the product.

IMPORTANT SAFETY & INSTALLATION INSTRUCTIONS

INSTRUCTIONS PERTAINING TO THE RISK OF FIRE ELECTRIC SHOCK , OR INJURY TO PERSONS

WARNING: When using electric products, basic precautions should always be followed, including the following:

1. Read all the Safety and Installation Instructions and Explanation of Graphic Symbols before using the product.
2. This product must be grounded. If it should malfunction or break down, grounding provides a path of least resistance for electric current to reduce the risk of electric shock. This product is equipped with a power supply cord having an equipment-grounding conductor and a grounding plug. The plug must be plugged into an appropriate outlet which is properly installed and grounded in accordance with all local codes and ordinances.
DANGER: Improper connection of the equipment-grounding conductor can result in a risk of electric shock. Do not modify the plug provided with the product – if it will not fit the outlet, have a proper outlet installed by a qualified electrician. Do not use an adaptor which defeats the function of the equipment-grounding conductor. If you are in doubt as to whether the product is properly grounded, check with a qualified serviceman or electrician.
3. Do not use this product near water – for example, near a bathtub, washbowl, kitchen sink, in a wet basement, or near a swimming pool, or the like.
4. This product should only be used with a stand or cart that is recommended by the manufacturer.
5. This product, either alone or in combination with an amplifier and speakers or headphones, may be capable of producing sound levels that could cause permanent hearing loss. Do not operate for a long period of time at a high volume level or a level that is uncomfortable. If you experience any hearing loss or ringing in the ears, you should consult an audiologist.
6. This product should be located so that its location or position does not interfere with its proper ventilation.
7. The product should be located away from heat sources such as radiators, heat registers, or other products that produce heat.
8. The product should be connected to a power supply only of the type described in the operating instructions or as marked on the product.
9. This product may be equipped with a polarized line plug (one blade wider than the other). This is a safety feature. If you are unable to insert the plug into the outlet, contact an electrician to replace your obsolete outlet. Do not defeat the safety purpose of the plug.
10. The power supply cord of the product should be unplugged from the outlet when left unused for a long period of time. When unplugging the power supply cord, do not pull on the cord, but grasp it by the plug.
11. Care should be taken so that objects do not fall and liquids are not spilled into the enclosure through openings.
12. The product should be serviced by qualified service personnel when:
 - A. The power supply cord or the plug has been damaged;
 - B. Objects have fallen, or liquid has been spilled into the product;
 - C. The product has been exposed to rain;
 - D. The product does not appear to be operating normally or exhibits a marked change in performance;
 - E. The product has been dropped, or the enclosure damaged.
13. Do not attempt to service the product beyond that described in the user maintenance instructions. All other servicing should be referred to qualified service personnel.
14. **WARNING:** Do not place objects on the product's power supply cord, or place the product in a position where anyone could trip over, walk on, or roll anything over cords of any type. Do not allow the product to rest on or be installed over cords of any type. Improper installations of this type create the possibility of a fire hazard and/or personal injury.

RADIO AND TELEVISION INTERFERENCE

WARNING: Changes or modifications to the instrument not expressly approved by Young Chang could void your authority to operate the instrument.

IMPORTANT: When connecting this product to accessories and/or other equipment use only high quality shielded cables.

NOTE: This instrument has been tested and found to comply with the limits for a Class B digital device, pursuant to Part 15 of the FCC Rules. These limits are designed to provide reasonable protection against harmful interference in a residential installation. This instrument generates, uses, and can radiate radio frequency energy and, if not installed and used in accordance with the instructions, may cause harmful interference to radio communications. However, there is no guarantee that interference will not occur in a particular installation. If this instrument does cause harmful interference to radio or television reception, which can be determined by turning the instrument off and on, the user is encouraged to try to correct the interference by one or more of the following measures:

- Reorient or relocate the receiving antenna.
- Increase the separation between the instrument and the receiver.
- Connect the instrument into an outlet on a circuit other than the one to which the receiver is connected.
- If necessary consult your dealer or an experienced radio/television technician for additional suggestions.

The normal function of this product may be disturbed by strong electro magnetic interference. If so, simply reset the product to resume normal operation by following the instruction manual. In case the function could not resume, please use the product in another location.

NOTICE

This apparatus does not exceed the Class B limits for radio noise emissions from digital apparatus set out in the Radio Interference Regulations of the Canadian Department of Communications.

AVIS

Le présent appareil numérique n'émet pas de bruits radioélectriques dépassant les limites applicables aux appareils numériques de la class B prescrites dans le Règlement sur le brouillage radioélectrique édicté par le ministère des Communications du Canada.

SAVE THESE INSTRUCTIONS

IMPORTANT SAFETY INSTRUCTIONS

- 1) Read these instructions.
- 2) Keep these instructions.
- 3) Heed all warnings.
- 4) Follow all instructions.
- 5) Do not use this apparatus near water.
- 6) Clean only with dry cloth.
- 7) Do not block any of the ventilation openings. Install in accordance with the manufacturer's instructions.
- 8) Do not install near any heat sources such as radiators, heat registers, stoves, or other apparatus (including amplifiers) that produce heat. Allow adequate ventilation for the power adapter. Do not hide it under a carpet or behind a curtain or place it in an enclosed space where heat buildup can occur. Do not defeat the safety purpose of the polarized or grounding-type plug. A polarized plug has two blades with one wider than the other. A grounding type plug has two blades and a third grounding prong. The wide blade or the third prong are provided for your safety. If the provided plug does not fit into your outlet, consult an electrician for replacement of the obsolete outlet.
- 9) Protect the power cord from being walked on or pinched, particularly at plugs, convenience receptacles, and the point where they exit from the apparatus.



- 10) Only use attachments/accessories specified by the manufacturer.
- 11) Use only with a cart, stand, tripod, bracket, or table specified by the manufacturer, or sold with the apparatus. When a cart is used, use caution when moving the cart/apparatus combination to avoid injury from tip-over.
- 12) Unplug this apparatus during lightning storms or when unused for long periods of time.
- 13) Refer all servicing to qualified service personnel. Servicing is required when the apparatus has been damaged in any way, such as power-supply cord or plug is damaged, liquid has been spilled or objects have fallen into the apparatus, the apparatus has been exposed to rain or moisture, does not operate normally, or has been dropped.

Warning: To reduce the risk of fire or electric shock, do not expose this apparatus to rain or moisture. Do not expose this equipment to dripping or splashing and ensure that no objects filled with liquids, such as vases, are placed on the equipment.

To completely disconnect this equipment from the AC Mains, disconnect the power supply cord plug from the AC receptacle.

Kurzweil International Contacts

Contact the appropriate Kurzweil office listed below to locate your local Kurzweil representative.

US Customers:

Young Chang North America
Kurzweil Home Products
6000 Phyllis Drive
Cypress, CA 90630
Tel: 310 637-2000
Fax: 310 637-2025

Customers outside the US:

Young Chang Co., LTD.
9th Floor, Bldg 102, I-Park
Jeongja-Dong, Bundang-Gu, Seongnam-Si
Gyeonggi-Do 463-859
South Korea
Tel: +82 31 786 7900
www.ycpiano.co.kr
www.youngchang.com



WWW

www.kurzweil.com



support@kurzweil.com



www.facebook.com/kurzweilmusicsystems/



www.twitter.com/KurzweilMusic



www.youtube.com/user/KurzweilTutorials

TABLE OF CONTENTS

INTRODUCTION	1
Primary Features	
Assembly Instructions	
Power Connection	
Volume	
Headphone Jacks	
Quick Start	
OVERVIEW	5
Input/Output Panel	
Control Panel Display, Buttons and Controls	
Operation	
DEMO MODE	8
VOICE MODE	8
PIANO SPLIT MODE	9
TRANSCOPE	9
METRONOME	9
Changing the Tempo	
Using Tap Tempo	
RECORDING	10
Start Recording	
Playing the Recording	
Erasing the Recording	
Punch-Ins	
Selecting and Saving Settings	
Transpose	
Reverb Level	
SETTINGS MODE	11
Touch	
Tune	
MIDI Channel	
Metronome Volume	
Local Control	
Auto Power Off	
Hard Reset (Restoring Factory Defaults)	
OS/Objects Version	
MIDI	14
About MIDI	
MIDI Channels	
MIDI In and Out Ports	
USB MIDI Connection	
Using Windows applications for MIDI control	
APPENDIX	16
ANDANTE CUP110 MIDI Implementation Chart	
ANDANTE CUP110 Demo Song List	
ANDANTE CUP110 Voice List	
ANDANTE CUP110 Specifications	

NOTES

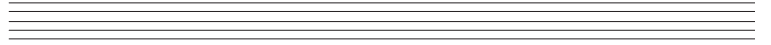

Congratulations on your purchase of the Kurzweil CUP110. You are certain to enjoy many hours exploring the variety of features as well as the beautiful preset voices.

The CUP110 is designed with the same sound technology from the world acclaimed Artis and PC3 Series keyboards. It includes Kurzweil's new German Grand piano.

Primary Features

- 88-Note, Fully-Weighted, Hammer-Action Keyboard
- 45 Watt 2-way, 4 Speaker, Stereo Sound System
- New German Grand piano
- 88 Preset Voices (including drum kits)
- 5 Drum Kits
- Scrolling alphanumeric LED display
- Piano Split Mode
- Transpose and Tuning settings
- Metronome and Tempo buttons
- 2 user "Favorite" preset voices
- 10 levels of keyboard sensitivity
- Performance Recorder
- Dedicated button to select the Grand Piano voice
- Preset Effects including Reverb, Echo, Delay, and Chorus
- 51 Built In Demo Songs
- Stereo Audio Input and Output Jacks
- 2 Headphone Jacks
- Standard MIDI In and Out ports
- USB "Plug & Play" Computer Port
- Matching Bench Included

Andante CUP110 Carton Contents

Your new Andante CUP110 carton should have the following:

- CUP110 instrument (main cabinet)
- DC power adapter, with AC power cord
- (2) Instrument stand side panels, (1) pedal unit, (1) back panel
- Hardware: (4) BM6X12 bolts, (4) CM6X50 bolts, (4) screw caps, (4) adjustable nut units
- Warranty Card
- Andante CUP110 User's Manual (this manual)

If you are missing any of the above, please contact your Kurzweil dealer. It is always a good idea to save the Andante CUP110 cartons, in case they are needed for shipment. Follow the procedure on the following pages to assemble the CUP110.

INTRODUCTION

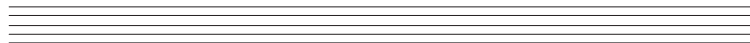

Assembly Instructions

In addition to the main piano cabinet, your instrument comes with a stand requiring assembly, using the parts shown below. Two people may be needed to complete the assembly, as the stand must first rest on the floor and then the instrument must be securely attached on top of it.

STEP 1:

Place the stand parts on a carpeted floor or blanket. Use the four long bolts to attach the pedal unit to the side panels. Insert the screw caps to cover the bolt ends. Use the four shorter screws to attach the back panel to brackets, as shown below.

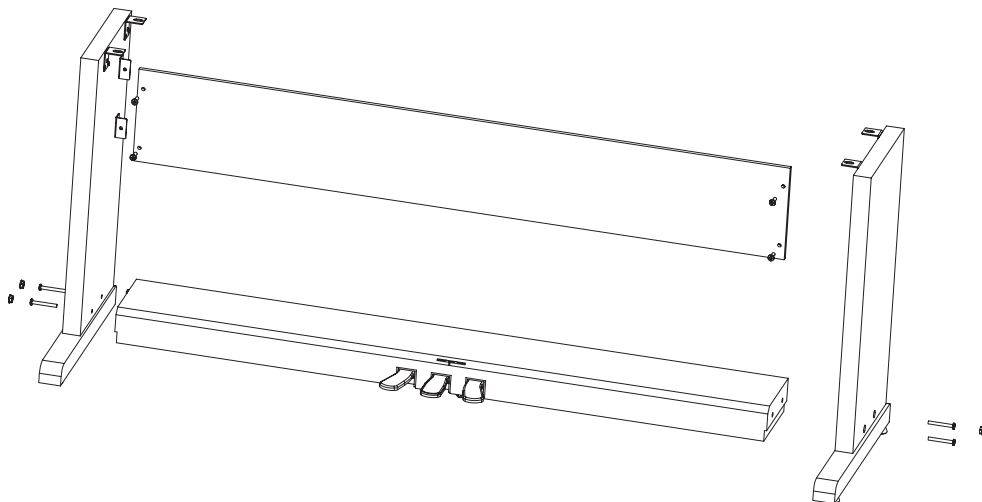

STEP 2:

Move the stand into an upright position and then place the instrument upon it. To avoid possible damage, don't let the weight of the body rest on the stand until it is properly aligned and secured with the four screws as shown. Rotate the pedal adjuster until it comes in firm contact with the floor surface. If the adjuster is not in firm contact with the floor, the pedal will wobble and cause malfunctions.

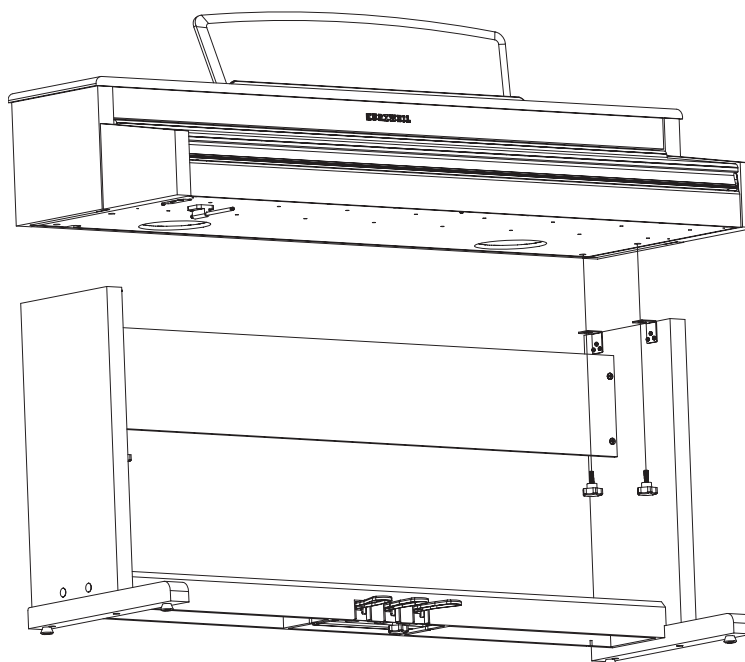



INTRODUCTION

STEP 3:

Insert the pedal cable connector into the pedal jack located on the bottom of the keyboard. Be sure that the connector is inserted in the correct orientation. Make sure that the cable clamp fastens to the pedal cable.



STEP 4:

Install the headphone hanger as shown in the picture at right.

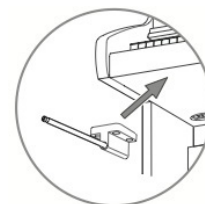

Power Connection

A DC power adapter supplies the Andante CUP110's power.

Connect the power adapter to the DC receptacle on the rear panel of the Andante CUP110. Then connect the power cord to an AC outlet.

CAUTION:

Use only the DC power adapter supplied with the Andante CUP110. Connecting the wrong DC power adapter could damage the instrument.

If the power adapter is damaged or lost, contact your Kurzweil dealer to order a replacement.

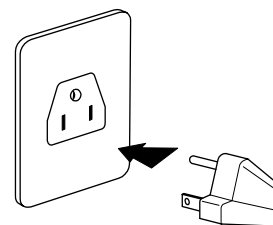

The AC plug shape will vary depending on location of use

After the CUP110 is set up, turn the power on. While the unit is performing its power-up routine some of the front panel buttons will flash. After a couple of seconds, the display will read **1 Grand Piano**. The CUP110 is now ready to play.

Use the Quick Start instructions on the following pages for the basic steps to change Voices or play one of the Demo Songs.

Volume

Before turning on the Andante CUP110, it's always a good idea to set the volume at its minimum setting (all the way to the left). For a generally comfortable level of volume while playing, set the knob at its middle position.

The Volume Control is located on the right end of the keyboard. Turn this knob from left to right (clockwise) to increase the volume. This adjusts the Andante CUP110 speaker and headphone audio volume. The Volume control does not affect the volume of the sound coming from external sources through the Audio In jacks on the rear panel.

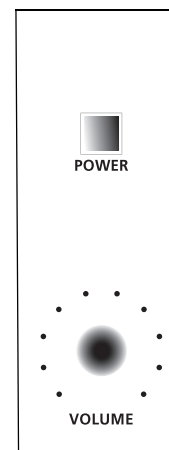

INTRODUCTION

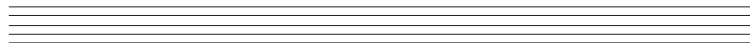

Headphone Jacks

The CUP110 has two stereo 1/4" headphone jacks located below the keyboard on the left end of the cabinet. Plugging in headphones provides privacy during practice. Both jacks operate the same so two people can play and hear the music together. When headphones are connected the CUP110's speakers are silent.

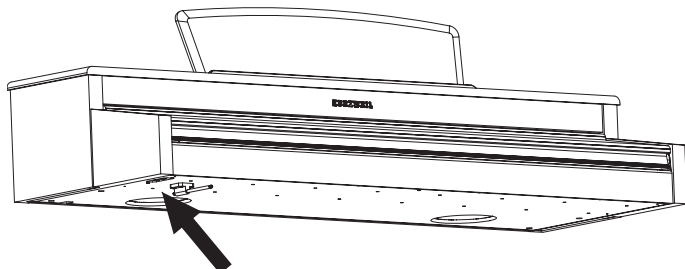

Quick Start

Playing the Voices

1. Turn on the power.
2. The **Voice** button LED is lit and the first voice (1 Grand Piano) is ready to play.
3. There are a number of different voices available. Press the **Prev-** or **Next+** button to step through the available voices.

Playing a Demo Song

1. Press the **Record** and **Play/Stop** buttons together to enter **Demo Mode**.
2. The first demo song immediately plays. The CUP110 continues to play each of the demo songs until you press the **Play/Stop** button.
3. At any time you can press the **Play/Stop** button to start or stop playing a demo song.
4. Press the **Prev-** or **Next+** button to play the previous or next demo song.
5. Simultaneously press the **Prev-** and **Next+** buttons to jump ahead 10 songs at a time.
6. Press the **Voice** button to exit **Demo Mode**.

Input/Output Panel

The Input/Output panel is located on the rear of the instrument cabinet.

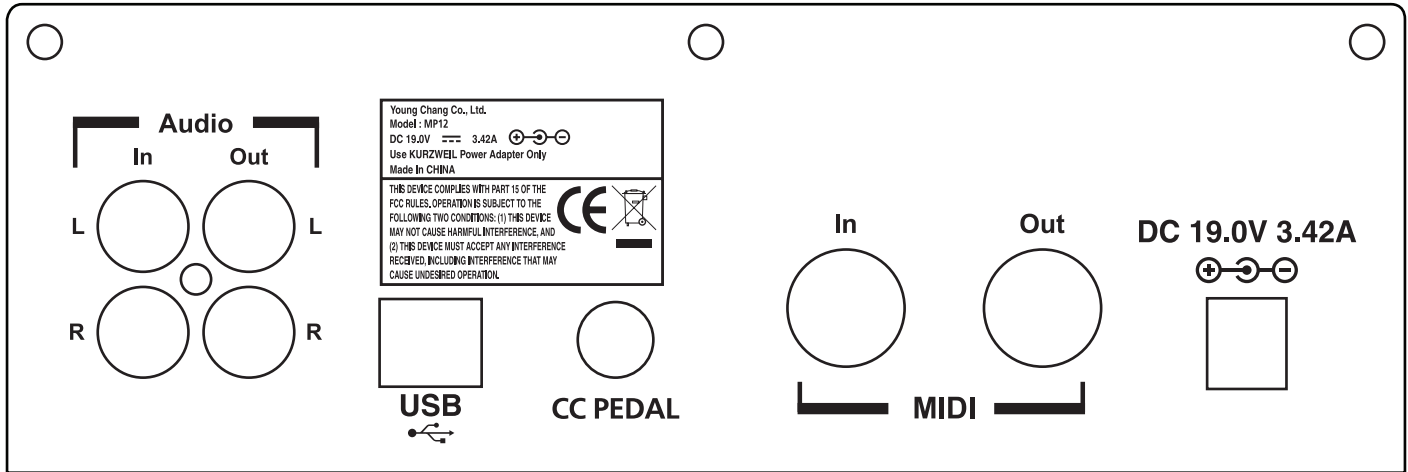

Audio In and Audio Out

Audio Out (RCA jacks) may be used to connect the Andante CUP110 to external audio equipment, such as an outboard mixer, powered speakers, or recording device.

Audio In jacks are used to connect the Andante CUP110's internal speakers to other devices such as a digital audio player or CD player. *Always turn off the CUP110's power before plugging or unplugging cables into the Audio In jacks.*

The Andante CUP110's Volume Control does not affect the volume of the sound coming from the Audio In jacks. Therefore it is best to use a device that has its own output level control and to use that to adjust the sound volume from the external device.

MIDI In and Out ports

Use the MIDI In and Out ports to connect the Andante CUP110 to other MIDI devices to receive and send MIDI data.

CC Pedal (Volume/Expression Pedal)

This jack is used to connect a continuous controller pedal for volume and expression control. The CUP110 requires a pedal with a TRS 1/4" connector and 10k linear potentiometer. Most manufacturers EXCEPT Yamaha and Korg make pedals with the same specifications and should work. Yamaha and Korg pedals typically use an exponential potentiometer and therefore will not work correctly. The CC-1 pedal is available from Kurzweil. You can order the CC-1 through your local Kurzweil dealer.

USB

Connect a USB cable to this port to send and receive MIDI or to connect to a computer to apply system updates.

OVERVIEW

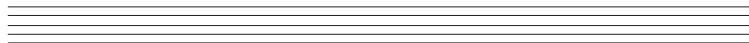

Control Panel Display, Buttons and Controls

The features labelled on the Andante CUP110's front panel below are discussed in detail in the following chapters. Throughout this manual button names are shown in **Bold Type**, and display screen text in *Italic Type*.

Display

The LED screen displays scrolling text indicating the current instrument mode or parameter settings.

Piano Button

No matter which mode is active, you may select this button to immediately return to the Grand Piano voice.

Voice Button

Press this button to enter *Voice Mode*.

Favorites 1 and 2

Select a previously stored favorite sound by pressing the **Favorites** button assigned to it.

Store the current sound by pressing and holding the desired **Favorites** button until the word *Saved* appears on the display.

Pressing the **Favorite 1 + Favorite 2** buttons simultaneously will initiate *Piano Split Mode*.

Metronome Button

Select this button to hear the metronome as you play.

Tempo Button

Use the **Tempo** button to access the tempo of the metronome, then make changes with **Prev-** or **Next+** buttons.

Transpose Button

This button will allow you to adjust the tuning of the keyboard in semitones, to a desired interval.

Settings Button

Press the **Settings** button to enter *Settings Mode*. Global settings affecting the instrument overall may be adjusted in this mode.

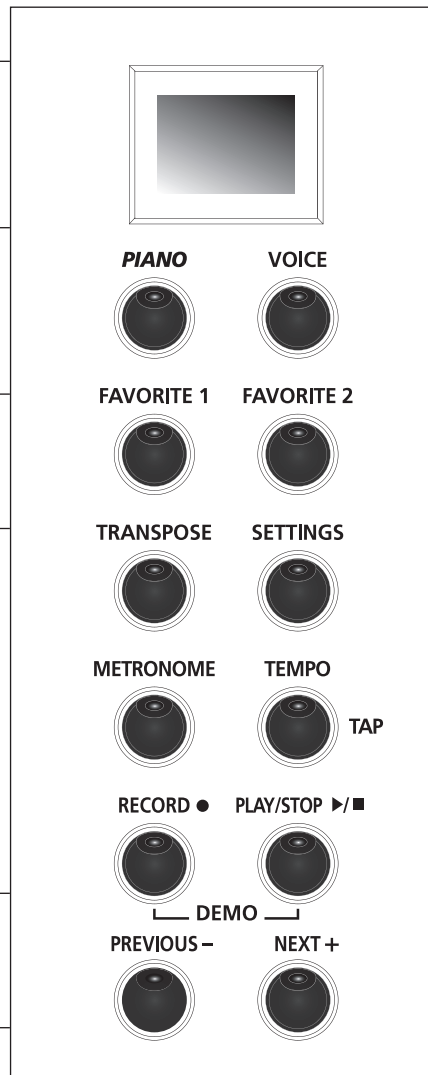

Recording and Play/Stop Buttons

Press the **Record** button to initiate *Record Mode*.

Select the **Play/Stop** button to play or stop recording, or play and stop Demo songs or a saved user song.

Press **Record** and **Play/Stop** together to enter *Demo Mode*.

Prev- and Next+ Buttons

Use these buttons to select the next higher or lower Voice or parameter value. When using the metronome, use these buttons to increase or decrease the tempo. These buttons are also used to tune or transpose.

Press and hold either button and it will repeat until it is released.

Pressing **Prev- / Next+** simultaneously allows you to reset certain parameters to a default value, or to jump quickly through a list of options.

Operation

The following sections describe how to use the controls for various purposes. Most of the CUP110's features are organized in groups called modes. The CUP110 has five operating modes that allow players to configure and apply these features, and to save settings for later access. The following sections describe each of the operating features:

- **DEMO MODE** explains how to play the pre-recorded songs in the CUP110.
- **VOICE MODE** explains how to access the variety of different voices available.
- **PIANO SPLIT MODE** explains how to divide the keyboard into 2 44-key regions for 4-hand use.
- The **TRANSCOPE**, **METRANOME** and **TEMPO** sections explains how to adjust these features.
- **SETTINGS MODE** describes a variety of global parameter settings in the CUP110.
- **RECORDING** explains how to record musical sequences.
- **MIDI** introduces the Musical Instrument Digital Interface functions in the CUP110.

DEMO MODE

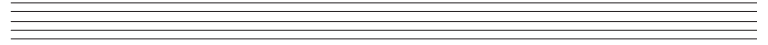

The Andante CUP110 has 51 pre-recorded grand piano songs performed in a variety of classical styles that demonstrate the Grand Piano Voice. See the Appendix for a complete list of the demo songs and their corresponding keyboard keys.

Selecting Demo Songs

Press the **Record + Play/Stop** buttons together to enter **Demo Mode**. The first song, a Brahms Rhapsody, will begin to play. Its song number and name will display on the screen. When the first song ends, the next demo song begins to play. This will continue through all 51 demo songs.

Press the **Play/Stop** button to start or stop playing a demo song.

To skip through the demo song list and select a different song to play, press the **Prev-** button to select the previous demo song or the **Next+** button to select the next demo song. You may press the **Play/Stop** button to stop the current demo song, then press the **Play/Stop** again to start the next demo song selected. To skip forward 10 songs at a time, press the **Prev- / Next+** button pair simultaneously.

Demo Song Select via Keyboard

In **Demo Mode**, keyboard keys A0 through B4 are assigned to each demo song. To select a demo song using the keyboard, first press the **Record** button then press and release its corresponding key.

To exit **Demo Mode**, press either the **Voice** or **Piano** buttons.

VOICE MODE

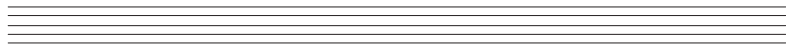

When you turn on the Andante CUP110, **Voice Mode** is active and the Grand Piano voice is already selected and ready to play. **Grand Piano** is the default voice. The Appendix of this manual provides a complete list of available voices and their corresponding keyboard keys.

Selecting Voices

If the Andante CUP110 is not already in **Voice Mode**, press the **Voice** button to return to your sounds.

To select another voice, press the **Prev-** or **Next+** button to navigate through the available voices. A complete list of the Voices, with corresponding keyboard keys, is included in the Appendix.

Voice Select via Keyboard

For a direct selection of desired Voices, while in **Voice Mode**, pressing the **Voice** button again will cause the Voice LED to blink, the display will show the scrolling text “**Strike a key.**” Pressing a keyboard key at this point will select the Voice that corresponds to that key. The instrument will then return to normal **Voice Mode**.

To cancel “**Voice Select Via Keyboard Mode**” and return to normal without changing the current Voice, simply select **Voice** again (or any other button, and you may then perform the normal function of that button).

Storing a Favorite Voice

You can quickly save any voice as a favorite. Just select a voice then press and hold one of the **Favorites** buttons. The voice is now stored in that location.



PIANO SPLIT MODE

Piano Split mode divides the CUP110 keyboard into an upper and lower region, above or below the F4 key. Each region then functions as a 44-key instrument: the left region is transposed up two octaves; the right is transposed down two octaves. This allows the instrument to be played with four hands. The left pedal will function as sustain on the left zone, the right pedal will function as sustain on the right zone.

Entering Piano Split Mode

Pressing the **Favorite 1 + Favorite 2** buttons simultaneously will initiate *Piano Split Mode*. The display will scroll “*PS Piano Split*” and then just “*PS.*” The **Favorites** buttons will remain lit while in this mode.



TRANPOSE

To enter *Transpose Mode* press the **Transpose** button. The Transpose LED will blink, and the **Voice** LED will turn off. The display will indicate the current transposition. Pressing the **Next+** or **Prev-** buttons will adjust the transposition between -24 and 24 in steps of 1 semitone.

Press **Prev- /Next+** simultaneously to reset the Transpose value to 0.

To exit Transpose Mode, press **Transpose** again, or the **Voice** button, to return to *Voice Mode*. If the Transpose value is not 0, the **Transpose** LED will remain lit, to indicate that the keyboard is currently transposed.



METRONOME

When the **Metronome** button is selected, the metronome will be heard through the piano speakers when playing. It will be set to its default tempo (120 beats per minute) upon powering on the instrument up but it can range from 20 to 300 BPM. To change the *Metronome Volume*, see the *Settings* section of this manual.

Changing the Tempo

To change the metronome tempo, press the **Tempo** button. Its LED lights and the display shows the current tempo in beats-per-minute (BPM). Press the **Prev-** button to decrease the tempo (to a low of 20 BPM) or press the **Next+** button to increase the tempo (up to the maximum of 300 BPM).

While the **Tempo** button LED remains lit, the display will show the selected tempo. To return to the default setting of 120 BPM, press the **Prev- /Next+** button pair. Hitting any other button will exit *Tempo mode* and the display will show the current **Voice** number.

Using Tap Tempo

Pressing the **Tempo** button repeatedly will allow you to set the tempo manually. Your tapping intervals will be measured and displayed in beats-per-minute.

RECORDING

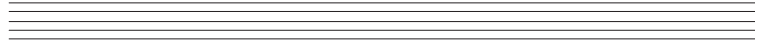

The CUP110's recorder allows you to record and play back a song.

Start Recording

1. Select the voice you want to use. Press **Record**.

If the Metronome is turned on when **Record** is pressed, the Metronome will stop in order for the click or rhythm to stay synchronized with the recorder when **Play** is pressed. When **Play** is pressed, a countoff click will be heard before recording begins.

2. Press **Play/Stop** to begin the recording. Perform the song now.
3. Press **Play/Stop** to end the recording.

Playing the Recording

You can now listen to the song you've recorded.

1. Press **Play/Stop** to listen to your song.
2. Press **Play/Stop** again to stop the playback.

Erasing the Recording

You can erase the entire song by recording "nothing:"

1. Press **Record**.
2. Press **Play/Stop** to begin.
3. Press **Play/Stop** again.

Punch-Ins

"Punching in" is a way to edit or correct mistakes on a recording without re-recording the entire track.

1. Press **Play/Stop** to begin playing the song.
2. When the song reaches the part you need to correct, press **Record**. Play the corrected notes.
3. Press **Play/Stop** to finish the punch-in.

*NOTE: If you don't press the **Play/Stop** button after you punch-in, you will erase the remaining portion of the track.*

SETTINGS MODE

The **Settings Mode** includes parameters that allow you to change the overall behavior of the entire instrument.

The following parameters are available in **Settings Mode**:

- Transpose
- Reverb Level
- Touch Sensitivity
- Tune
- MIDI Channel
- Metronome Volume
- Local Control
- Auto Power Off
- Hard Reset
- OS/Object

Selecting and Saving Settings

Press the **Settings** button to enter **Settings Mode**. Pressing the **Settings** button repeatedly allows you to choose one of the parameters listed above. Once you choose a parameter, you will use the **Prev-** or **Next+** buttons to navigate the values of that parameter. Pressing the **Voice** or **Piano** button will exit this mode.

Transpose

The Transpose parameter allows you to adjust the overall pitch of the keyboard up or down in semitone intervals.

Press the the **Settings** button until the screen displays **Transpose: (0** is the factory default). To transpose the pitch up, press the **Next+** button for each semitone up in pitch. To lower or transpose down, Press the **Prev-** button to lower the semitone pitch. Pressing the **Prev- / Next+** button pair will reset the transposition back to factory default of 0. The transposition has a range of -24 to +24. This offers a two octave transposition range up or down.

Reverb Level

The reverb level parameter controls the level of the reverb effects used on a voice. Press the **Settings** button until the screen reads **REVERB LEVEL:20** (factory default). To increase the reverb effect, press the **Next+** button. To decrease the reverb effect press the **Prev-** button. You can adjust the effect level from 0% (no effect) to 100%. Pressing the **Prev- / Next+** button pair will reset the effect level back to factory default of 20%.

SETTINGS, CON'T

Touch

Use this parameter to adjust the keyboard touch sensitivity to your playing technique.

Press the **Settings** button until the screen displays **Touch:Linear** (factory default). To change the setting, press the **Next+** button to advance to the next desired Touch. Press the **Prev-** button down to reverse the steps. The following are the available settings:

Linear	Best Dynamic Range for all sounds (Factory Default Setting).
Light (1-3)	For players with a light touch. Adjust this parameter to achieve a good dynamic range. These settings are from Light 1, a slightly light touch, to Light 3, a very light touch.
Hard (1-3)	For players with a heavier touch. Adjust this parameter to achieve a good dynamic range. These settings range from Hard 1, a slightly harder touch, to Hard 3, a very hard touch.
Piano Touch	Best for piano dynamics.
Easy Touch	Light touch, especially for younger players.
GM Receive	Select this when playing General MIDI songs.

The Touch setting is remembered across power cycles. Pressing the **Prev- / Next+** button pair will reset the Touch level back to factory default of **Linear**.

Tune

This parameter allows you to adjust the Andante CUP110 tuning to match other instruments or recordings.

Press the **Settings** button until the display reads **TUNE:0** (factory default is A - 440). To increase the tuning, press the **Next+** button from 0 to 100 cents. To lower or reduce the tuning, press the **Prev-** button from 0 to -100 cents. Pressing **Prev- / Next+** button pair will reset the tuning back to factory default of 0 or A-440.

MIDI Channel

This parameter controls the MIDI transmit channel used for **Voice Mode**. Press the **Settings** button until the display reads **CHANNEL: 1** (Factory Default). You can select Channels 1 through 9, or Channels 11 through 15. Channel 16 is reserved for the metronome. Pressing the **Prev- / Next+** button pair will reset the MIDI Channel back to the factory default of 1.

For more information on MIDI, see the following section of this manual.

Metronome Volume

This setting ranges from **1** (lowest) to **9** (loudest). The default setting is **9**. In **Settings Mode**, press the **Prev-** or **Next+** button to reach the desired volume level. The Metronome setting is remembered across power cycles.

Local Control

When you play the CUP110 keyboard you hear the resident or “local” voices, because this parameter is normally set to **On**. When using your CUP110 with an external sequencer or computer, turn this setting to **Off** to avoid creating a MIDI loop which may result in stuck notes or “echoes”. Press either the **Prev-** or **Next+** button to set this parameter.

Auto Power Off

This energy-saving feature will automatically shut off power to the unit after a period of inactivity. Simply pressing the power button will power up the unit once again. This allows you to reduce overall power consumption, and also extends the lifetime of the instrument. Press the **Settings** button until the display reads **AutoPowerOff**. Options are

Disabled, 15 min, 30 min, 1 hour, 2 hours or 4 hours. The default value is **30 min**. Pressing the **Prev- /Next+** button pair will reset to default.

Hard Reset (Restoring Factory Defaults)

This function resets the Andante CUP110 to the original factory default settings. All user changes, saved Favorites, and user recorded songs are erased. This action cannot be undone.

1. Press the **Settings** button until the display reads **HARD RESET?**
2. To perform the Hard Reset function press the **Next+** button once.
3. The display now reads **CONFIRM?**
4. Press the **Next+** button again confirm and to reset the CUP110. The unit will then erase its user memory, restore all factory settings and reboot.

If you want to cancel the Hard Reset and remain in **Settings Mode**, press the **Prev-** button to confirm. Press any other button to exit **Settings Mode**.

There is an alternate method for a Hard Reset on your Andante CUP110:

1. Hold the C8 key down while switching on the power.
2. Continue to hold C8 down until you see "RESETTING" (scrolling) in the display then release.

OS/Objects Version

To check for possible updates to your operating system in **Settings Mode** press the **Settings** button until "OS" is displayed. This will display the current operating software and objects version.

The display first shows the OS version, then the Object version. Visit the Kurzweil website (www.kurzweil.com) to verify that your CUP110 has the latest versions. These are located under the Downloads tab for the CUP110. Complete installation instructions are included in the downloaded files. A standard USB cable will be required for this operation.

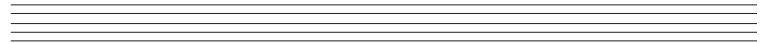

About MIDI

MIDI is the acronym for **M**usical **I**nstrument **D**igital **I**nterface. It is the industry standard protocol which allows the exchange of musical data between electronic musical instruments, devices (such as a sequencer), and computers. MIDI enables MIDI-equipped devices designed by different manufacturers to communicate MIDI data to each other.

MIDI data is sent or received using standard MIDI cables to connect to other MIDI devices or a USB cable to connect to a computer. The CUP110 is equipped with conventional MIDI In and Out ports, and a USB port. The Andante CUP110 has a standard class-compliant USB-MIDI implementation. It does not require the installation of any additional drivers.

MIDI Channels

Similar to television channels, MIDI protocol transmits multiple channels of MIDI performance data. Typical MIDI instruments can play up to 16 channels at the same time. Each channel can be assigned its own voice.

To change and/or assign MIDI channels, enter **Settings Mode** and select the MIDI Channel parameter. See the MIDI Implementation chart at the end of this chapter for details.

MIDI In and Out Ports

The CUP110 is equipped with the conventional MIDI In and Out ports. The MIDI In port is used to receive MIDI data from another MIDI device; the MIDI Out port is used to transmit the MIDI data generated by the CUP110 to another MIDI device; the MIDI Thru port passes MIDI In data along to an external device.

When you connect the MIDI Out of the CUP110 to the MIDI In of another instrument, you can play the sounds of both instruments simultaneously from the CUP110's keyboard.



When you connect the MIDI In of the CUP110 to the MIDI Out of another controller, you can control the CUP110 using the other controller.



USB MIDI Connection

In addition to the conventional MIDI In and Out ports, the Andante CUP110 also has a USB (Universal Serial Bus) port on the panel on the back of the piano. You can connect the CUP110 directly to a computer with a USB cable. This connection transmits and receives MIDI data between the CUP110 and the computer.

The Andante CUP110 supports the “Plug and Play” feature used in the Windows XP or higher and Macintosh operating systems. No drivers are required to use this connection; but you may need to enable MIDI on your computer’s sound and audio control panel.

To use the Andante CUP110 as a MIDI controller with a computer, use any Type-A to Type-B USB cable. By default, the CUP110 acts as a MIDI controller (not a hard drive) when connected to a computer.

If you have a sequencer program installed on your computer, you can use this USB connection to record and play your music. The Andante CUP110’s recorder is actually a simple sequencer and the performance you record into the CUP110’s memory is MIDI performance data. Using a computer-based sequencer program provides unlimited memory, editing, and the ability to post on the Internet.

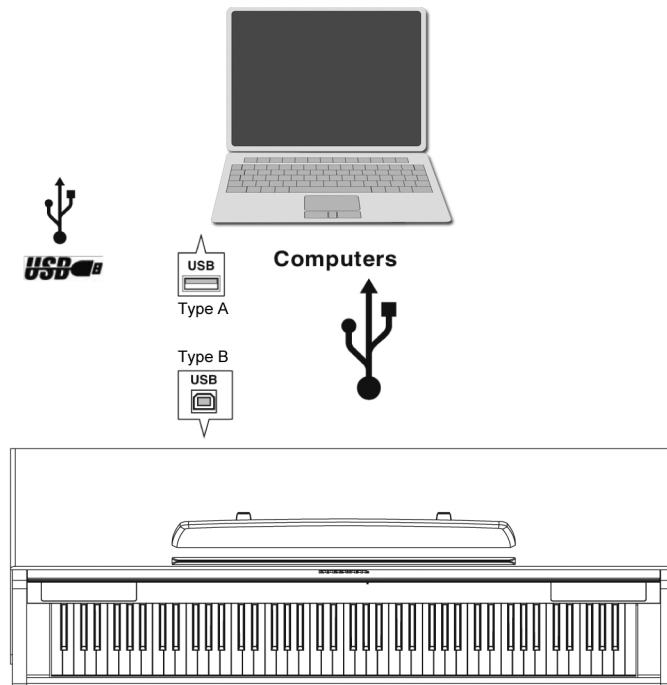

Using Windows applications for MIDI control

Certain apps (like Windows Media Player - WMP) released with Windows Vista or later can no longer play MIDI songs triggering external MIDI devices; WMP is only routed to the internal Microsoft GS Synthesizer.

This means the MIDI app you choose to use must natively offer its own built-in MIDI mapping abilities. Most commercial MIDI software products for PC have a configuration screen which includes the MIDI device mapping necessary to route to an external MIDI device such as the Andante CUP110.

APPENDIX

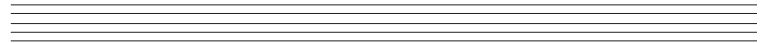

ANDANTE CUP110 MIDI Implementation Chart

Models: Andante CUP2A/110/120

Manufacturer:
Young Chang

Date: 2/14/2014
Version 2.0

Function	Transmitted	Recognized	Remarks
Basic Channel	Default	1	Memorized
	Changed	1 - 16	
Mode	Default	Mode 3	Use Multi mode for multi-timbral applications
	Messages	All	
	Altered		
Note Number		0 - 127	Key Range: A0-C8
	True Voice	12 - 120	
Velocity	Note ON	O	
	Note OFF	O	
After Touch	Keys	X	
	Channels	O	
Pitch Bender		X	O
Control Change	0, 32 Bank Select (MSB, LSB) 7 Volume 10 Pan 11 Expression 64 Sustain Pedal 66 Sostenuto Pedal 67 Soft Pedal	O	0 - 31 32 - 63 (LSB) 64 - 127
Program Change		O	0 - 127
	True #		0 - 127
System Exclusive		O	O*
System Common	Song Pos.	X	O
	Song Sel.	X	O
	Tune	X	X
System Real Time	Clock	X	O
	Messages	X	O
Aux Messages	Local Control	X	O
	All Notes Off	X	O
	Active Sense	X	X
	Reset	X	X
Notes	*Manufacturer's ID = 07 Device ID: default = 0		O = yes X = no

ANDANTE CUP110 Demo Song List

No.	Song Name	Key	Composer
1	Rhapsody	A0	J. Brahms
2	Prelude I	A#0	J. S. Bach
3	Invention No. 4	B0	J. S. Bach
4	Invention No. 8	C1	J. S. Bach
5	Prelude II	C#1	J. S. Bach
6	Aria Goldberg	D1	J. S. Bach
7	Fuga II	D#1	J. S. Bach
8	Sonatine Op.36	E1	M. Clementi
9	Klavierstück	F1	W. A. Mozart
10	Piano Sonate	F#1	W. A. Mozart
11	Rondo in D	G1	W. A. Mozart
12	Piano Sonate K.3	G#1	W. A. Mozart
13	Piano Sonate K.5	A1	W. A. Mozart
14	Minuet in G	A#1	L. V. Beethoven
15	Bagatelle No. 25	B1	L. V. Beethoven
16	Sonatine Op.55	C2	Fr. Kuhlau
17	March Militaire	C#2	F. P. Schubert
18	Moments Musicaux	D2	F. P. Schubert
19	Impromptu No. 2	D#2	F. P. Schubert
20	Impromptu No. 4	E2	F. P. Schubert
21	La Chevaleresque	F2	J.F. Burgmüller
22	Without words	F#2	J. L. F. Mendelssohn
23	Venetianisches	G2	J. L. F. Mendelssohn
24	Sostenuto	G#2	F. F. Chopin
25	Valse KK	A2	F. F. Chopin
26	5 Mazurkas	A#2	F. F. Chopin
27	Valse Op.69 No. 2	B2	F. F. Chopin
28	Grande Valse	C3	F. F. Chopin
29	Valse Op.64 No. 2	C#3	F. F. Chopin
30	Nocturne No. 2	D3	F. F. Chopin
31	Valse Op.64 No. 1	D#3	F. F. Chopin
32	Preludes in Db	E3	F. F. Chopin
33	Fantaisie-Improm	F3	F. F. Chopin
34	Träumerei	F#3	R. Schumann
35	Fröhlicher Landma	G3	R. Schumann
36	Von fremden Länd	G#3	R. Schumann
37	Liebesträume #3	A3	F. Liszt
38	Dolly's Dreaming	A#3	T. Oesten
39	Frühlingsstimmen	B3	J. Strauss
40	The Swan	C4	Saint-Saëns
41	Blumenlied	C#4	G. Lange
42	Valsette	D4	F. Borowski
43	Old French Air	D#4	P. I. Tchaikovsky
44	Mazurka	E4	P. I. Tchaikovsky
45	Polka	F4	P. I. Tchaikovsky
46	Barcarolle	F#4	P. I. Tchaikovsky
47	Humoreska	G4	A. Dvorak
48	Suite 'Peer Gynt	G#4	E. Grieg
49	Suite Bergamasque	A4	C. A. Debussy
50	Rêverie	A#4	C. A. Debussy
51	Arabesque I	B4	C. A. Debussy

APPENDIX

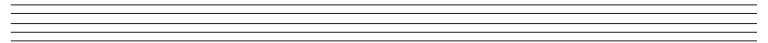

ANDANTE CUP110 Voice List

NO.	KEY	VOICE	NO.	KEY	VOICE
1	A0	Grand Piano	45	F4	Flute
2	A#0	Bright Piano	46	F#4	Horns+Str
3	B0	Concert Piano	47	G4	Winds+Str
4	C1	Jazz Piano	48	G#4	Gothic Orch
5	C#1	Piano & Pad	49	A4	Silver Orch
6	D1	Piano & Vox	50	A#4	Pastoral Orch
7	D#1	Piano & Strings	51	B4	Victory Orch
8	E1	Blues Piano	52	C5	Imperial Orch
9	F1	Rock Piano	53	C#5	Vivaldi Orch
10	F#1	Upright Piano	54	D5	Magic Orch
11	G1	Piano, Bass & Ride **	55	D#5	LA Strings
12	G#1	Piano & Bass **	56	E5	Oct Strings
13	A1	Piano Split **	57	F5	Pizzicato
14	A#1	Stevie's EP	58	F#5	Adagio Str
15	B1	These Eyes EP	59	G5	Tremolando
16	C2	Hotrod EP	60	G#5	Fast Strings
17	C#2	E Piano+Pad	61	A5	Solo Violin
18	D2	Supertramp EP	62	A#5	Solo Viola
19	D#2	Woodstock	63	B5	Solo Cello
20	E2	Classic DX	64	C6	Full Choir
21	F2	FM E Piano	65	C#6	Aah Vocals
22	F#2	Classic 70's	66	D6	Jazzy Scat
23	G2	E Piano & EBass **	67	D#6	Synth Vox
24	G#2	FM Piano & EBass **	68	E6	E-Bass
25	A2	Crisp Clav	69	F6	Slap Bass
26	A#2	Steely Clav	70	F#6	Fretless Bass
27	B2	Wah Clav	71	G6	Upright Bass
28	C3	Fuzz Clav	72	G#6	AC Guitar
29	C#3	Harpichord	73	A6	Nylon Guitar
30	D3	Mellow Organ	74	A#6	Chorus Guitar
31	D#3	Sweet Organ	75	B6	Lead Guitar
32	E3	Perc Organ	76	C7	Xylophone
33	F3	Gregg's B	77	C#7	Marimba
34	F#3	Blues+Gospel	78	D7	Vibraphone
35	G3	Gospel B	79	D#7	Koto
36	G#3	Farfisa	80	E7	Mbira
37	A3	Pipe Stops	81	F7	Sitar
38	A#3	Chapel Organ	82	F#7	Harp/Mallets
39	B3	All Stops	83	G7	Steel Drums
40	C4	AllStop Choir	84	G#7	Solid Kit
41	C#4	Pop Horns	85	A7	Latin Kit
42	D4	Salsa Horns	86	A#7	Electric Kit
43	D#4	Trumpet	87	B7	Brush Kit
44	E4	Tenor Sax	88	C8	Percussion

** HIGHLIGHTED ROWS INDICATE VOICE PAIRS THAT TRANSMIT OVER SEPARATE MIDI CHANNELS; THESE CANNOT BE SELECTED DIRECTLY OVER MIDI

ANDANTE CUP110 Specifications

Keyboard	88 Note, hammer-action keyboard with adjustable touch sensitive keys.
Preset Programs	88 Expressive sounds, including new German Grand Piano.
Piano Split Mode	Dual 44-key operation
Effects	Dual ambience and effect processors (reverberation and chorus). Rich and complex effects from the PC3 Series.
Recorder	Single track song recording
Sound System	4-speaker, 4-amplifier 45-watt stereo sound system.
Headphones	(2) ¼" stereo audio outputs
I/O Jacks	MIDI In and Out connectors 2 RCA stereo input and 2 RCA stereo output jacks
USB	(1) port, "Plug and Play" functionality allows MIDI over USB for connecting to/from an external computer sequencer; no software driver needed.
Pedals	3 pedals: Soft, Sostenuto, Sustain. Optional Volume/expression Pedal Unit.
Polyphony	128 voices
Finish	Satin Rosewood
Dimensions	141.4cm L x 50.3cm W x 89.5cm H (4ft 7.6in L x 1ft 8in W x 2ft 11in H)
Weight	60 Kg (132.27 lbs)
Power	90-250V AC 50/60Hz free voltage; external power supply 19V, 3.42A DC

KURZWEIL

www.kurzweil.com
www.facebook.com/kurzweilmusicsystems

Andante CUP110 User Manual
910563-001